

Long-distance capacitive proximity sensor

# E2K-C

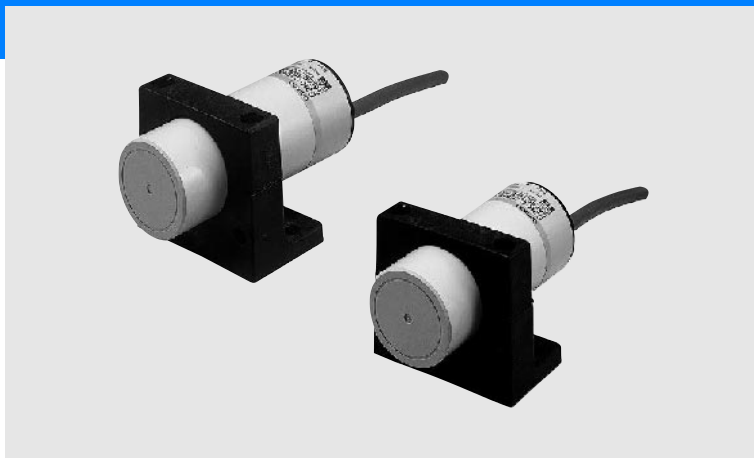

## Capacitive Proximity Sensor with Adjustable Sensitivity

- Detects both metallic and non-metallic objects (glass, lumber, water, oil, plastic, etc.) without direct contact.
- DC models acquire CE marking



### Ordering Information

#### Sensors

Shape	Sensing distance	Model		
		Output specifications	Operating status	
			NO	NC
Unshielded  34 dia.	 3 to 25mm	DC 3-wire NPN DC 3-wire PNP	<b>E2K-C25ME1</b> <b>E2-KC25MF1</b>	<b>E2K-C25ME2</b> <b>E2K-C25MF2</b>
		AC 2-wire Models	<b>E2K-C25MY1</b>	<b>E2K-C25MY2</b>

#### Accessories (Order Separately)

##### Mounting Brackets

Shape	Model	Quantity	Remarks
	<b>Y92E-A34</b>	1	Supplied with the product.

Rating/Performance

Item	Model	E2K-C25M□1	E2K-C25M□2	E2K-C25MY1	E2K-C25MY2
Sensing distance *		25 mm			
Sensing distance adjustable range		3 to 25 mm			
Sensing object		Conductors and dielectrics			
Standard sensing object		with grounded metal: 50 x 50 x 1t mm			
Differential distance		15% max. of sensing distance (when adjusted to 25 mm ±10% with standard object)			
Response frequency		70 Hz		10 Hz	
Power supply(Operating voltage range)		12 to 24 VDC, ripple (p-p): 10% max.,(10 to 40 VDC)		100 to 220 VAC (90 to 250 VAC) 50/60 Hz	
Current consumption		E models: 10 mA max. at 12 VDC, 16 mA max. at 24 VDC			
Leakage current		Y models: 1 mA max. at 100 VAC (50/60 Hz) with output turned OFF., 2 mA max. at 200 VAC (50/60 Hz) with output turned OFF.			
Control output	Switching capacity	200 mA max.		5 to 200 mA (resistive load)	
	Residual voltage	2 V max. (under load current of 200 mA with cable length of 2 m)			
Indicator lamp		Detection indicator (red LED)		Operation indicator (red LED)	
Operating status (with sensing object approaching)		E1, Y1 models: NO E2, Y2 models: NC			
Protective circuits		Reverse connection protection, surge absorber		Surge absorber	
Ambient temperature		Operating/Storage: -25°C to 70°C (with no icing or condensation)			
Ambient humidity		Operating/Storage: 35% to 95%RH (with no condensation)			
Temperature influence		±15%max. of sensing distance at 23° within temperature range -10°C to 55°C			
Voltage influence		±2% max. of sensing distance at a voltage between 85% and 115% of the rated power supply voltage		±2% max. sensing distance at a voltage ranging from 90% to 120% of a rated power voltage of 100 VAC and from 80% to 120% of a rated supply voltage of 200 VAC	
Insulation resistance		50 MΩ min. (at 500 VDC) between current carry parts and case			
Dielectric strength		1000 VAC 50/60 Hz for 1 min between energized part and case		1,500 VAC 50/60 Hz for 1min between energized part and case	
Vibration resistance		10 to 55 Hz, 1.5 mm double amplitude for 2 hours each in X, Y, and Z directions			
Shock resistance		Destruction: 500 m/s <sup>2</sup> for 10 times each in X, Y, and Z directions			
Protective structure		IEC 60529 IP66			
Connection method		Pre-wired models (standard length: 2 m)			
Weight (Packed state)		Approx. 200 g			
Material	Case	Heat-resistant ABS resin			
	Sensing surface				
Accessories		Mounting bracket, instruction manual			

\* The set distances are sensing distances applicable to standard sensing objects. Refer to Engineering Data for sensing distances applicable to other types of objects.

## Characteristic data (typical)

### Sensing Distance Change by Sensing Object (Typical)

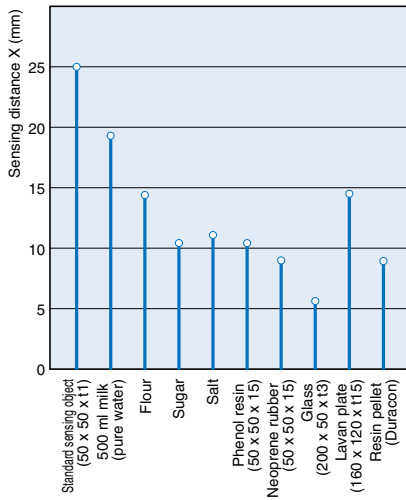

## Output Circuit Diagram

### DC 3-wire Models

Operating status	Model	Timing chart	Output circuit
NO	E2K-C25ME1	<p>Sensing object: Yes (High), No (Low)</p> <p>Load (between brown and black): Operates (High), Releases (Low)</p> <p>Output voltage (between black and blue): H (High), L (Low)</p> <p>Operation indicator (red): ON (High), OFF (Low)</p>	<p>* 1. 200 mA max. (load current) * 2. When a transistor is connected</p>
NC	E2K-C25ME2	<p>Sensing object: Yes (High), No (Low)</p> <p>Load (between brown and black): Operates (Low), Releases (High)</p> <p>Output voltage (between black and blue): H (High), L (Low)</p> <p>Operation indicator (red): ON (High), OFF (Low)</p>	<p>* 1. 200 mA max. (load current) * 2. When a transistor is connected</p>
NO	E2K-C25MF1	<p>Sensing object: Yes (High), No (Low)</p> <p>Load (between brown and black): Operates (High), Releases (Low)</p> <p>Output voltage (between black and blue): H (High), L (Low)</p> <p>Operation indicator (red): ON (High), OFF (Low)</p>	<p>* 1. Maximum load current: 200 mA * 2. Current flows in this direction if the circuit incorporates the transistor.</p>
NC	E2K-C25MF2	<p>Sensing object: Yes (High), No (Low)</p> <p>Load (between brown and black): Operates (Low), Releases (High)</p> <p>Output voltage (between black and blue): H (High), L (Low)</p> <p>Operation indicator (red): ON (High), OFF (Low)</p>	<p>* 1. Maximum load current: 200 mA * 2. Current flows in this direction if the circuit incorporates the transistor.</p>

AC 2-wire Models

Operating status	Model	Timing chart	Output circuit
<b>NO</b>	<b>E2K-C25MY1</b>		
<b>NC</b>	<b>E2K-C25MY2</b>		

## Operation

### Sensitivity adjustment

Remove the rear rubber cap of the E2K-C and turn the potentiometer in the hole to adjust the sensitivity of the E2K-C.

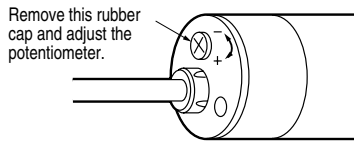

The sensing distance increases by turning the potentiometer clockwise and decreases by turning the potentiometer counterclockwise. The potentiometer can make 15±3 valid turns and then make slip turns because the potentiometer does not have a stopper. The slip turns will not, however, damage the potentiometer.

1. Slowly turn the potentiometer clockwise until the E2K-C turns on with no sensing object.

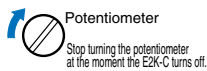

2. Turn the potentiometer counterclockwise until the E2K-C turns off with the sensing object located within the sensing distance.



3. The E2K-C will be in stable operation if there is a difference of 1.5 turns or more between the points the E2K-C is turned on and off, otherwise the E2K-C will not be in stable operation.

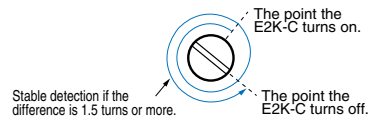

4. Set the potentiometer midway between the two points.

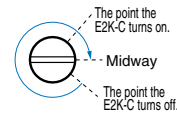

5. If the distance of each sensing object varies, take step 2 with the sensing object located at the farthest sensing distance to be applied.

## Precautions

### Correct Use

#### Design

#### Effects of Surrounding Metal

During Proximity Sensor installation provide a distance of 80 mm min. from the surrounding metal objects to prevent the Sensor from being affected by metal objects other than the sensing object.

If installing the Sensor with the L-shaped mounting bracket, provide a distance of 20 mm min. between the face of the sensing head and the mounting bracket.

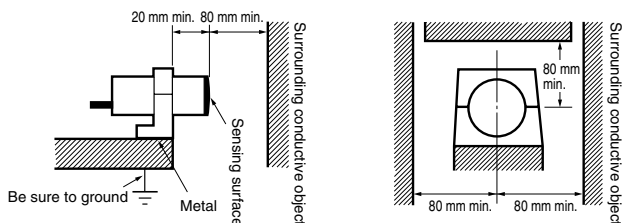

#### Mutual Interference

Space the two Sensors at a distance exceeding 100 mm to prevent mutual interference.

#### Face-to-face Mounting

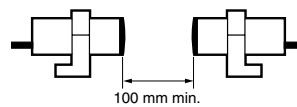

#### Parallel Mounting

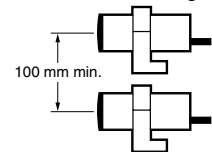

#### Effect of High-frequency Electro-magnetic Field

The E2K-C may malfunction if there is an ultrasonic washer, high-frequency generator, transceiver, or inverter nearby.

**Sensing Object**

- Sensing Object Material. The E2K-C can detect almost any type of object. The sensing distance of the E2K-C, however, will vary with the electrical characteristics of the object, such as the conductance and inductance of the object, and the water content and capacity of the object. The maximum sensing distance of E2K-C will be available if the object is made of grounded metal.

- Indirect Detection. In the case of the detection of objects in metal containers, each metal container must have a non-metallic window.

**Miscellaneous**

**Organic Solvents**

E2K-C has a case made of heat-resistant ABS resin. Be sure that the case is free from organic solvents or solutions containing organic solvents.

**Dimensions (Unit: mm)**

**Sensors**

**E2K-C25M□□**

**CAD file E2K\_01**

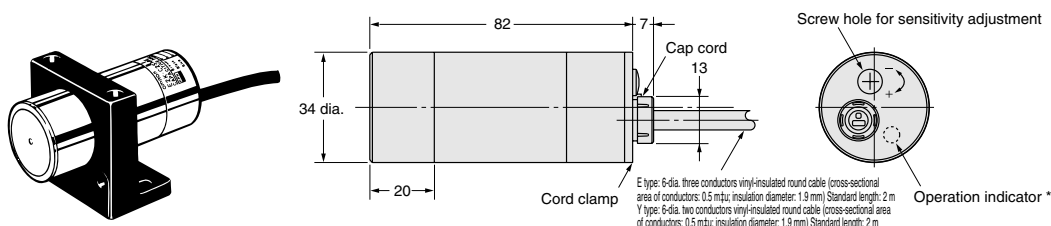

E type: 6-dia. three conductors vinyl-insulated round cable (cross-sectional area of conductors: 0.5 m<sup>2</sup>; insulation diameter: 1.9 mm) Standard length: 2 m  
 Y type: 6-dia. two conductors vinyl-insulated round cable (cross-sectional area of conductors: 0.5 m<sup>2</sup>; insulation diameter: 1.9 mm) Standard length: 2 m

\* E models: Detection indicator (red); Y models: Operation indicator (red)

**Accessories (Order Separately)\***

**L-shaped Mounting Bracket Y92E-A34**

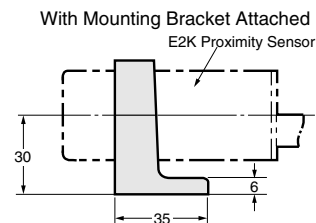
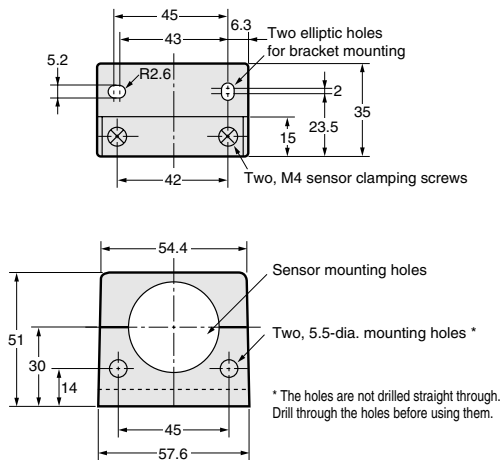
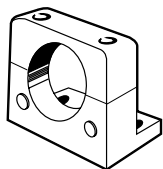

\* Attached to the product.