

MA4EX180H-1225T

Silicon Double Balanced HMIC™ Mixer, 1300 - 1900 MHz

Rev. V2

Features

- SOT-25 Low Cost Miniature Plastic Package
- 6.5 dB Typical Conversion Loss at 1550 MHz
- 7.6 dB Typical Conversion Loss at 1800 MHz
- +13 to +17 dBm LO Drive
- HMIC™ Patented Process
- Silicon High Barrier Schottky Diodes
- DC - 500 MHz IF Bandwidth

Description and Applications

M/A-COM's MA4EX180H-1225T is a silicon monolithic 1300-1900 MHz double balanced mixer in a low cost miniature surface mount SOT-25 package. The die uses M/A-COM's unique HMIC™ silicon/glass process to achieve low loss passive elements while retaining the advantages of high barrier silicon Schottky diodes.

These mixers are well suited for high volume wireless and cellular applications where small size and repeatability are required. Typical applications include frequency conversion, modulation, and demodulation for receivers and transmitters in both portable cellular and base station applications.

SOT-25 Package Outline (Topview)

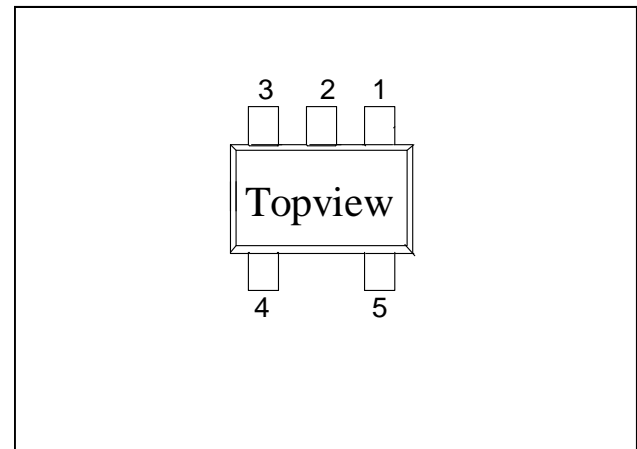

PIN Configuration

PIN	Function	PIN	Function
1	GND	4	RF
2	GND	5	LO
3	IF		

Absolute Maximum Ratings¹

Parameter	Maximum Ratings
Operating Temperature	-40 °C to +85 °C
Storage Temperature	-65 °C to +150 °C
Incident LO Power	+20 dBm
Incident RF Power	+20 dBm

1. Exceeding these limits may cause permanent damage.

Functional Schematic

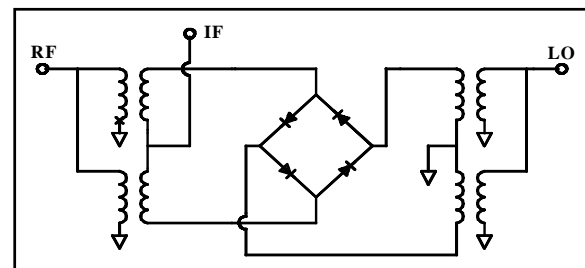

MA4EX180H-1225T



Silicon Double Balanced HMIC™ Mixer,
1300 - 1900 MHz

Rev. V2

Electrical Specifications: $T_A = + 25\text{ }^\circ\text{C}$

Parameter	Frequency Range	Test Conditions	Units	Min.	Typ.	Max.
Conversion Loss	1550 MHz	LO Drive = +15 dBm RF = -10 dBm, IF = 60 MHz	dB		6.5	7.5
	1300-1900 MHz				7.5	9.5
L - R Isolation	1550 MHz	LO Drive = +15 dBm RF Level = -10 dBm	dB		27.0	
	1300-1900 MHz				18.6	
L - I Isolation	1550 MHz	LO Drive = +15 dBm RF Level = -10 dBm	dB		28.9	
	1300-1900 MHz				24.0	
R - I Isolation	1550 MHz	LO Drive = +15 dBm RF Level = -10 dBm	dB		15.8	
	1300-1900 MHz				16.9	
RF VSWR	1550 MHz	LO Drive = +15 dBm RF Level = -10 dBm			1.4:1	
	1300-1900 MHz				2.1:1	
IF VSWR	DC - 500 MHz	LO Drive = +15 dBm RF Level = -10 dBm			1.5:1	
Input IP3	1550 MHz	LO Drive = +15 dBm IF = 60 MHz	dBm		19.5	23.0
	1300-1900 MHz				17.5	22.0
Input 1 dB Compression	1550 MHz	LO Drive = +15 dBm IF = 60 MHz	dBm		7.5	8.5
	1300-1900 MHz				7.5	9.5
IF 1 dB Bandwidth			MHz	0	500.0	

MA4EX180H-1225T



Silicon Double Balanced HMIC™ Mixer,
1300 - 1900 MHz

Rev. V2

Typical Performance Curves (LO Drive = +15 dBm, RF = -10 dBm, IF = 60 MHz)

Conversion Loss

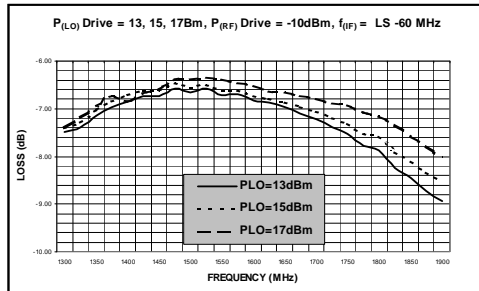

Isolation

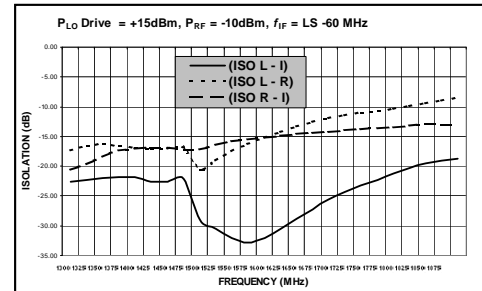

RF and IF VSWR

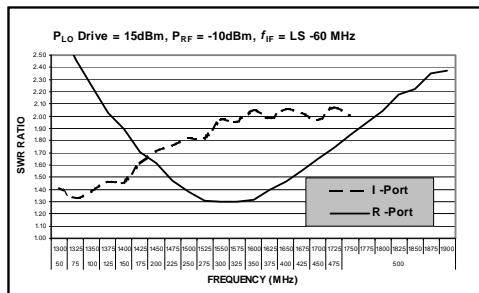

Third Order Intercept and Input 1 dB Compression Power

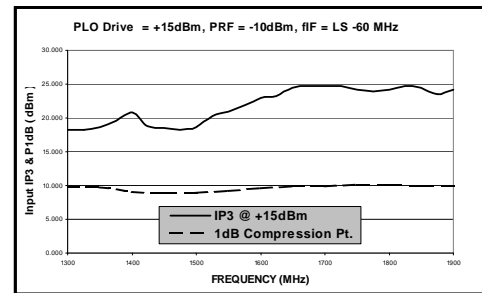

ADVANCED: Data Sheets contain information regarding a product M/A-COM Technology Solutions is considering for development. Performance is based on target specifications, simulated results, and/or prototype measurements. Commitment to develop is not guaranteed.
PRELIMINARY: Data Sheets contain information regarding a product M/A-COM Technology Solutions has under development. Performance is based on engineering tests. Specifications are typical. Mechanical outline has been fixed. Engineering samples and/or test data may be available. Commitment to produce in volume is not guaranteed.

• **North America** Tel: 800.366.2266 • **Europe** Tel: +353.21.244.6400
 • **India** Tel: +91.80.43537383 • **China** Tel: +86.21.2407.1588
 Visit www.macomtech.com for additional data sheets and product information.

M/A-COM Technology Solutions Inc. and its affiliates reserve the right to make changes to the product(s) or information contained herein without notice.

MA4EX180H-1225T

Silicon Double Balanced HMIC™ Mixer,
1300 - 1900 MHz

Rev. V2

SOT-25 Package Outline^{1,2}

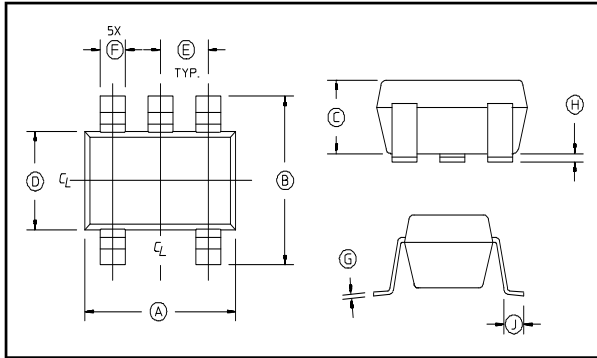

1. Dimensions do not include mold flash, protrusion or gate burrs which shall not exceed 0.0098 in (.25mm) per side.
2. Lead Coplanarity is 0.003 (0.08) max.

SOT-25 Dimensions

Dim	Inches		Millimeters	
	Min.	Max.	Min.	Max.
A		.122	2.70	3.10
B	.100	.118	2.54	3.00
C	—	.051	—	1.30
D	.063 REF.		1.60 REF.	
E	.032	.043	.80	1.10
F	.014	.020	.35	.50
G	.003	—	.08	—
H	.000	.006	.00	.15
J	.018 REF.		.45 REF.	

Ordering Information

Part Number	Package
MA4EX180H-1225T	Tape and Reel