

PART NO.: WEJ324RD

Page:1/4

3.0mm ROUND RED LED LAMP

Features

- ※ Reliable and rugged
- ※ Low current requirement
- ※ IC compatible

Description

The RED Lamps are made

With GaP/GaP chip and Red Diffused epoxy resin

Package Dimensions

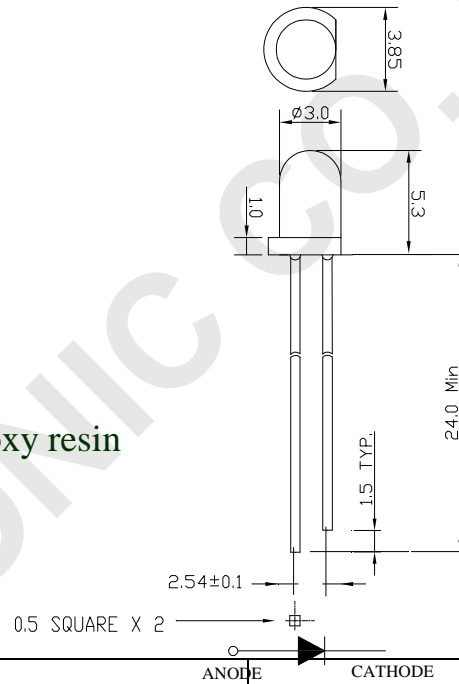

Part NO.	LED chip		Lens Color
	Material	Emitting Color	
WEJ324RD	GaP/ GaP	Red	Red Diffused

Notes:

1. All dimensions in mm tolerance is $\pm 0.2\text{mm}$ unless otherwise noted.
2. An epoxy meniscus may extend about 1.5mm down the lead.
3. Burr around bottom of epoxy may be 0.5mm max.

PART NO.: WEJ324RD**Page:2/4**

3.0mm ROUND RED LED LAMP

Absolute Maximum Ratings(Ta=25°C)

Parameter	Symbol	Rating	Unit
Power Dissipation	PD	78	mW
Forward Current (DC)	IF	30	mA
Peak Forward Current(Pulse width ≤0.1msec duty ≤1/10)	IFP	100	mA
Reverse Voltage	VR	5.0	V
Electro-Static-Discharge	ESD	1000	V
Operation Temperature Range	Topr	-25to+85	°C
Storage Temperature Range	Tstg	-40to+100	°C
Lead Soldering Temperature(1.6mm from body) for 5 seconds		260	°C

Typical Electrical and Optical Characteristics(Ta=25°C)

Parameter	Symbol	Condition	Min.	Typ.	Max.	Unit
Luminous Intensity	Iv	If=20mA	3	6		mcd
Forward Voltage	Vf	If=20mA		2.1	2.5	v
Peak Wavelength	λ P	If=20mA		700		nm
Dominant Wavelength	λ D	If=20mA		645		nm
Reverse Current	Ir	Vr=5v			10	uA
Viewing Angle	2 θ 1/2	If=20mA		55		deg
Spectrum Line Half width	Δ λ	If=20mA		50		nm

PART NO.: WEJ324RD

3.0mm ROUND RED LEDLAMP

Page:3/4

Typical Electrical / Optical Characteristics Curves

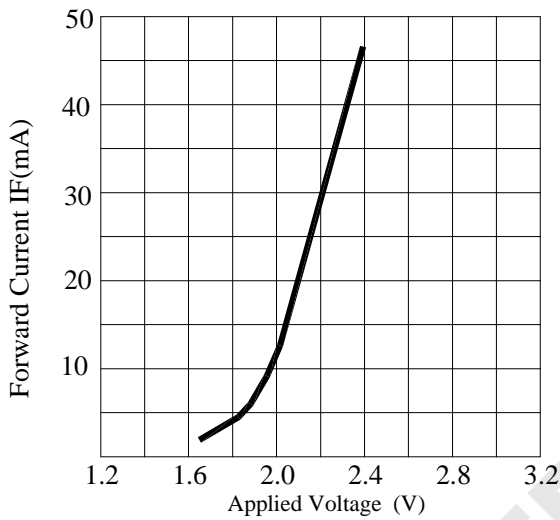

FORWARD CURRENT VS. APPLIED VOLTAGE

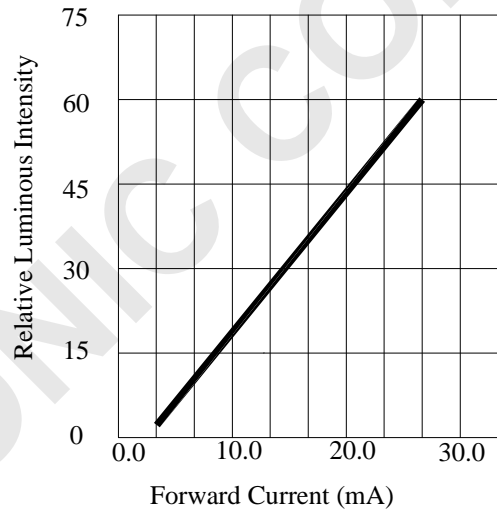

FORWARD CURRENT VS. LUMINOUS INTENSITY

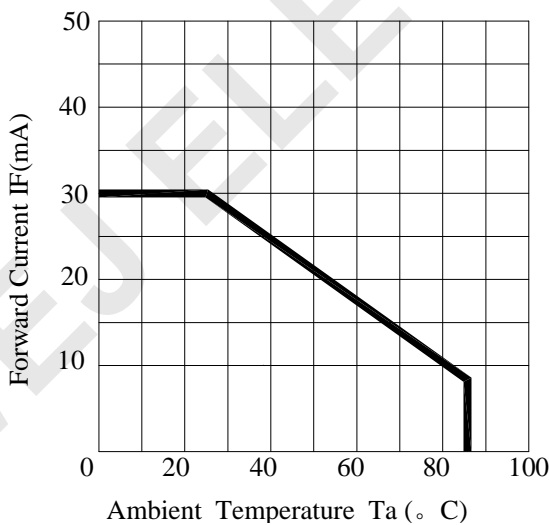

AMBIENT TEMPERA TURE VS.FORWARD CURRENT

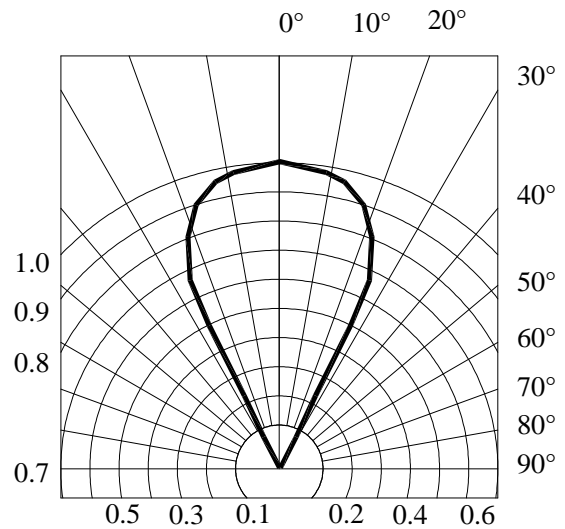

RADIATION DIAGRAM

PART NO.: WEJ324RD
3.0mm ROUND RED LED LAMP

Page:4/4

ENCASED TYPE

PLASTIC PACKAGE
QUANTITY : 1,000 PCS

YONG ER JIA ELECTRONIC CO.,LTD	
PART NO. : WEJ324RD	
V f: <u> </u> v	IV: <u> </u> mcd
Wld: <u> </u> nm	BIN: <u> </u>
Date: <u> </u>	Q C: <u> </u>
Q'TY: <u> </u> PCS	LOT NO: <u> </u>

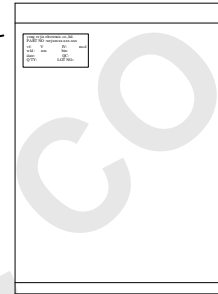

INNER BOX
QUANTITY: 10 PACKETS
TOTAL:15,000 PCS

PART NO.	WEJ324RD					
LOT NO.	XXXXXXXXXXXX					
BIN CODE	XX	XX	XX	XX	XX	TOTAL
QUANTITY	xxpcs	xxpcs	xxpcs	xxpcs	xxpcs	xxpcs
DATE	XXXX XX XX					

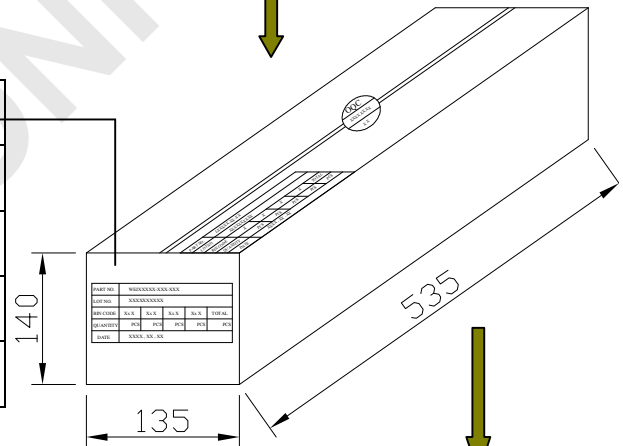

OUTER CARTON
QUANTITY: 4 BOX
TOTAL:60,000 PCS

C/T NO.	XX
PART NO.	WEJ324RD
QUANTITY	Xxxxx pcs
N.W.	XX KGS
G.W	XX KGS
REMARK	

