



SAW Components

SAW Tx 2in1 Filter

WCDMA band V / WCDMA band II

Series/type:	B9312
Ordering code:	B39192B9312N410
Date:	May 31, 2006
Version:	2.0



Data Sheet



Application

- Low-loss RF filter for mobile telephone WCDMA band V / band II systems, transmit path (Tx)
- Usable passband:
 - Filter 1 (band V): 25 MHz
 - Filter 2 (band II): 60 MHz
- Impedance transformation from:
 - Filter 1 (band V): 100 Ω to 50 Ω
 - Filter 2 (band II): 100 Ω to 50 Ω
- Balanced to unbalanced operation



Features

- Package size 2.0 x 1.6 x 0.68 mm³
- Package code QCS10I
- RoHS compatible
- Approximate weight 0.008 g
- Package for **Surface Mount Technology (SMT)**
- Ni, gold-plated terminals
- **Electrostatic Sensitive Device (ESD)**

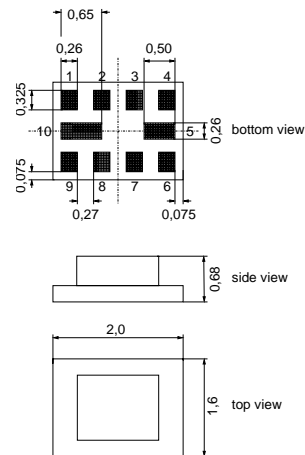

Pin configuration

- 1 Output [Filter 1: band V]
- 4 Output [Filter 2: band II]
- 6,7 Input balanced [Filter 2: band II]
- 8,9 Input balanced [Filter 1: band V]
- 2,3,5,10 Case ground

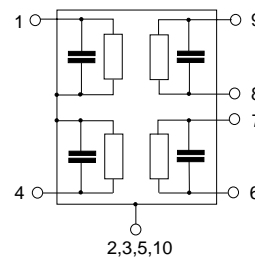



Data Sheet



Characteristics filter 1 (WCDMA band V)

Temperature range for specification: $T = -15\text{ °C to }+80\text{ °C}$
 Terminating source impedance: $Z_S = 100\ \Omega$ (balanced)
 Terminating load impedance: $Z_L = 50\ \Omega$ (unbalanced)

		min.	typ. @ 25 °C	max.	
Center frequency	f_C	—	836.5	—	MHz
Maximum insertion attenuation	α_{\max}				
824.0 ... 849.0 MHz		—	1.6	2.2	dB
Amplitude ripple (p-p)	$\Delta\alpha$				
824.0 ... 849.0 MHz		—	0.7	1.5	dB
Input VSWR					
824.0 ... 849.0 MHz		—	1.7	2.0	
Output VSWR					
824.0 ... 849.0 MHz		—	1.7	2.0	
Input amplitude balance (S_{31}/S_{21})					
824.0 ... 849.0 MHz		-1.0	-0.6/0.7	1.0	dB
Input phase balance ($\phi(S_{31}) - \phi(S_{21}) + 180^\circ$)					
824.0 ... 849.0 MHz		-10.0	-2/+1	10.0	°
Common mode suppression	S_{cs21}				
824.0 ... 849.0 MHz		23.0	28.0	—	dB
Attenuation	α				
0.0 ... 779.0 MHz		35.0	42.0	—	dB
779.0 ... 804.0 MHz		25.0	31.0	—	dB
869.0 ... 1570.0 MHz		33.0	36.0	—	dB
1570.0 ... 1580.0 MHz		43.0	48.0	—	dB
1580.0 ... 2547.0 MHz		35.0	43.0	—	dB
2547.0 ... 6000.0 MHz		25.0	34.0	—	dB



SAW Components

B9312

SAW Tx 2in1 Filter

836.5 / 1880.0 MHz

Data Sheet



Maximum ratings

Operable temperature range	T	-30/+85	°C	
Storage temperature range	T _{stg}	-40/+85	°C	
DC voltage	V _{DC}	5	V	
ESD voltage	V _{ESD}	100 ¹⁾	V	machine model, 10 pulses
Input power at				
WCDMA band V	P _{IN}	10	dBm	continuous wave @ +55°C ambient
Tx band				

¹⁾ acc. to JESD22-A115A (machine model), 10 negative & 10 positive pulses.



Transfer function filter 1 (WCDMA band V)

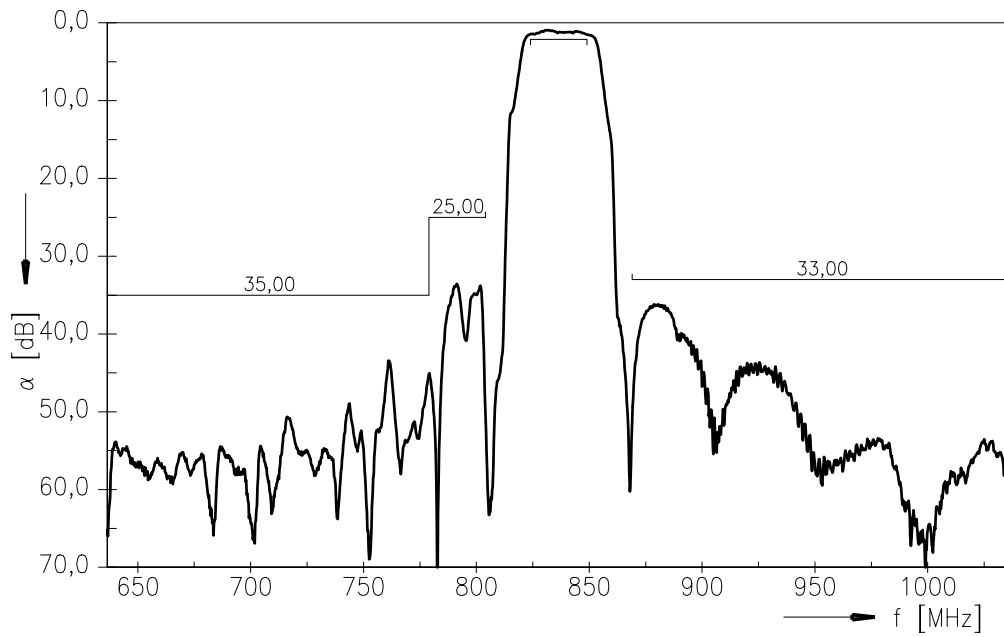

Transfer function filter 1 (WCDMA band V) - wideband

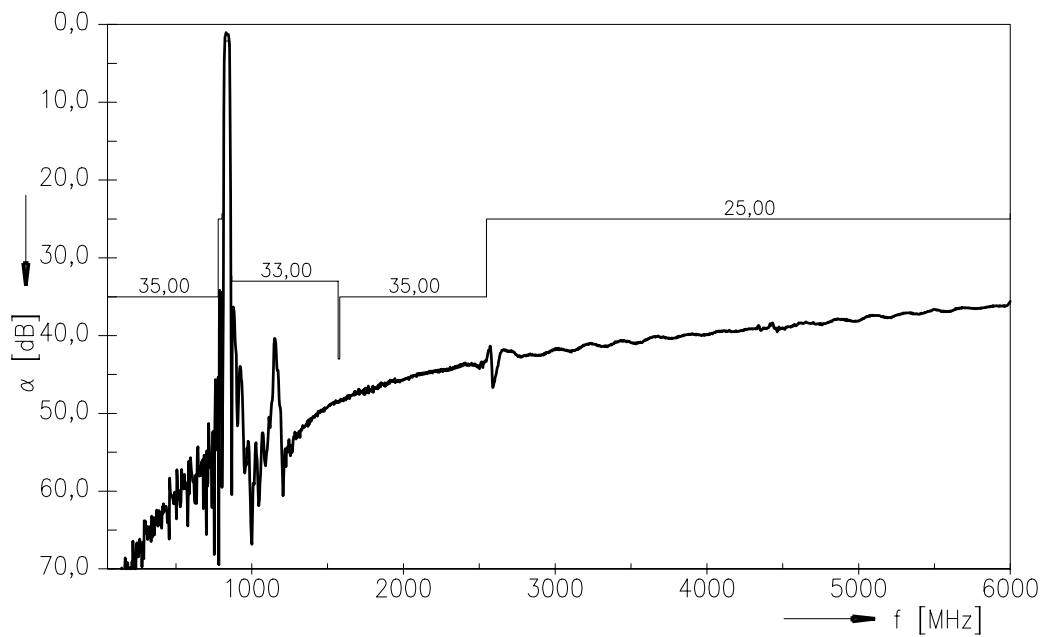



Data Sheet



Smith charts filter 1 (WCDMA band V)

S₁₁ function

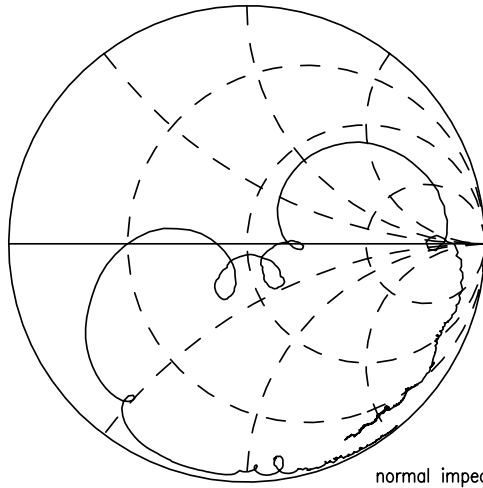

normal impedance: 100.00 Ω

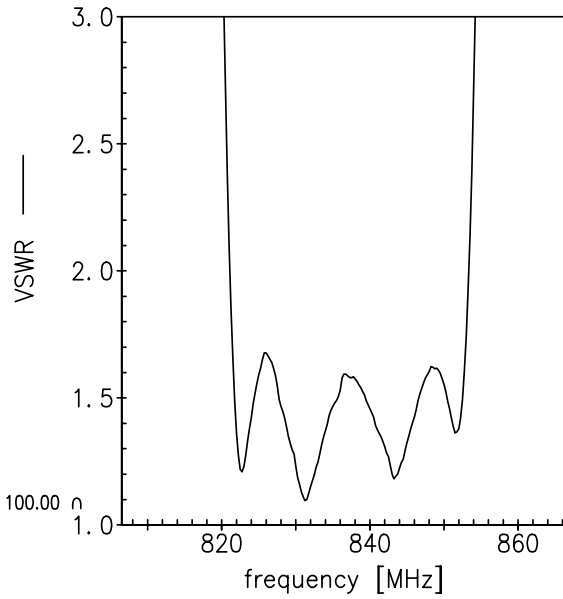

S₂₂ function

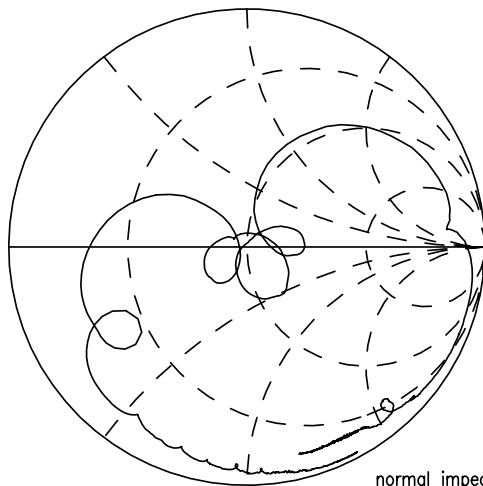

normal impedance: 50.00 Ω

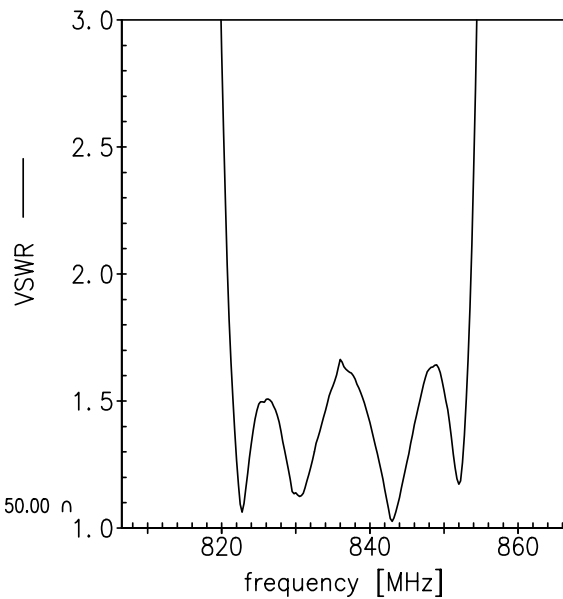



Data Sheet



Characteristics filter 2 (WCDMA band II)

Temperature range for specification: T = -15 °C to +80 °C
 Terminating source impedance: Z_S = 100 Ω (balanced) || 18nH
 Terminating load impedance: Z_L = 50 Ω (unbalanced)

		min.	typ. @ 25 °C	max.	
Center frequency	f _C	—	1880.0	—	MHz
Maximum insertion attenuation	α _{max}				
1850.0 ... 1910.0 MHz		—	2.4	3.8	dB
Amplitude ripple (p-p)	Δα				
1850.0 ... 1910.0 MHz		—	1.0	2.4	dB
Input VSWR					
1850.6 ... 1909.4 MHz		—	1.8	2.3	
Output VSWR					
1850.6 ... 1909.4 MHz		—	1.8	2.3	
Input amplitude balance (S₃₁/S₂₁)					
1850.0 ... 1910.0 MHz		-1.1	-0.7/0.7	1.1	dB
Input phase balance (φ(S₃₁) - φ(S₂₁) + 180°)					
1850.0 ... 1910.0 MHz		-10.0	-3/+3	10.0	°
Common mode suppression	S _{cs21}				
1850.0 ... 1910.0 MHz		23.0	29.0	—	dB
Attenuation	α				
0.0 ... 1580.0 MHz		45.0	54.0	—	dB
1580.0 ... 1770.0 MHz		30.0	42.0	—	dB
1770.0 ... 1830.0 MHz		18.0	36.0	—	dB
1930.6 ... 1990.0 MHz		33.0 ¹⁾	35.7	—	dB
1990.0 ... 2500.0 MHz		30.0	35.5	—	dB
2500.0 ... 6000.0 MHz		30.0	40.0	—	dB

1) Attenuation of WCDMA signal determined by

$$\int_{-\infty}^{\infty} |S_{ds21}(f)H_{RRC}(f - f_C)|^2 df$$

with f_C ranging from 1932.4 MHz (lowest Rx channel) to 1987.6 MHz (highest Rx channel).
 H_{RRC}(f) is the transfer function of the root-raised cosine transmit pulse shaping filter according to 3GPP TS 25.101 with the following normalization:

$$\int_{-\infty}^{\infty} |H_{RRC}(f)|^2 df = 1$$



SAW Components

B9312

SAW Tx 2in1 Filter

836.5 / 1880.0 MHz

Data Sheet



Maximum ratings

Operable temperature range	T	-30/+85	°C	
Storage temperature range	T _{stg}	-40/+85	°C	
DC voltage	V _{DC}	5	V	
ESD voltage	V _{ESD}	50 ¹⁾	V	machine model, 10 pulses
Input power at				
WCDMA band II	P _{IN}	10	dBm	continuous wave @ +55°C ambient
Tx band				

¹⁾ acc. to JESD22-A115A (machine model), 10 negative & 10 positive pulses.



Transfer function filter 2 (WCDMA band II)

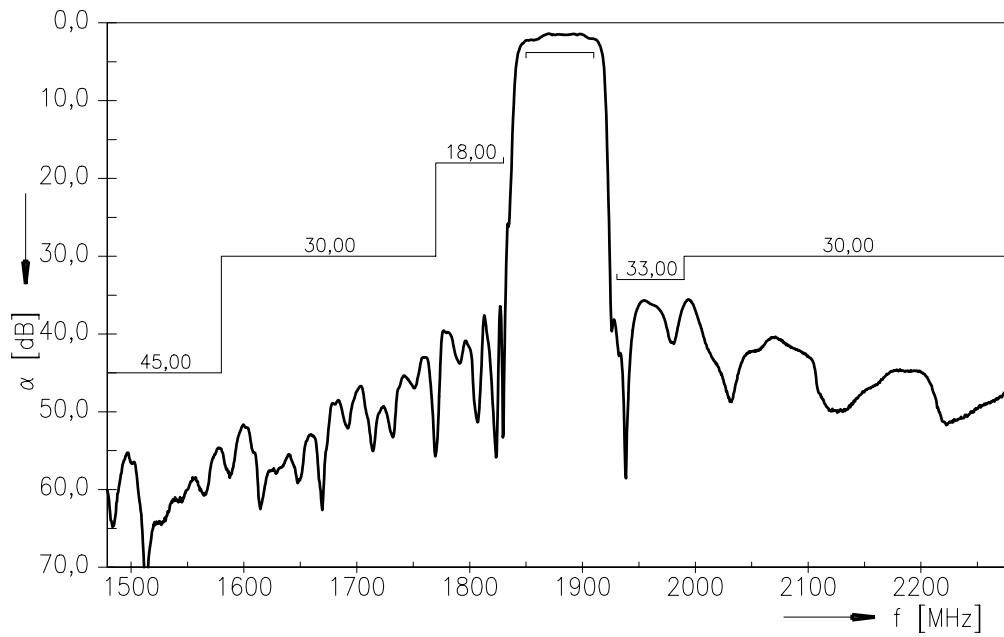

Transfer function filter 2 (WCDMA band II) - wideband

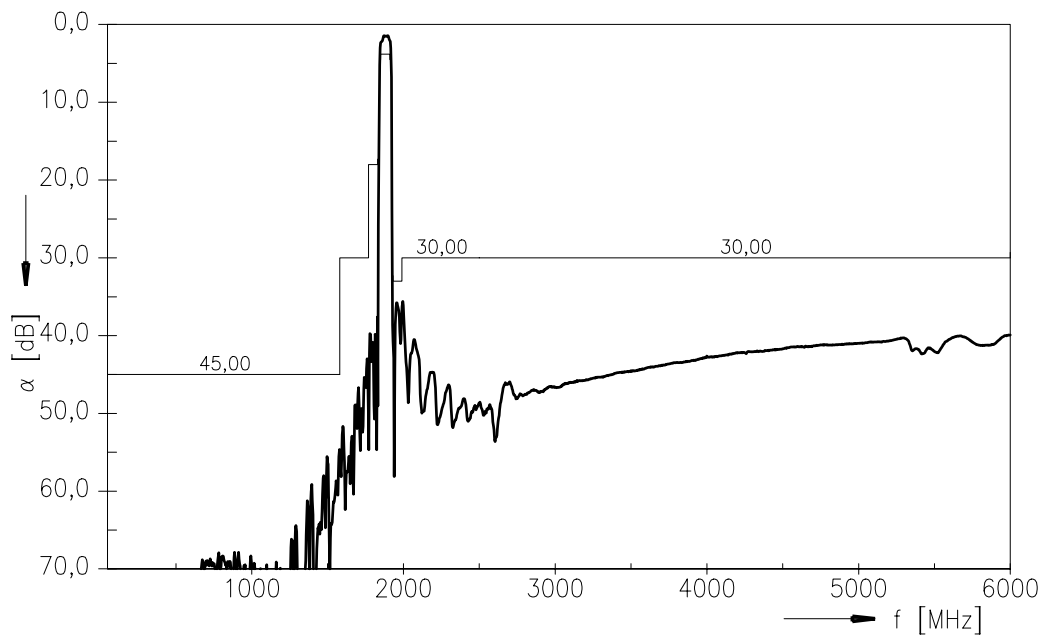



Data Sheet



Smith charts filter 2 (WCDMA band II)

S₁₁ function

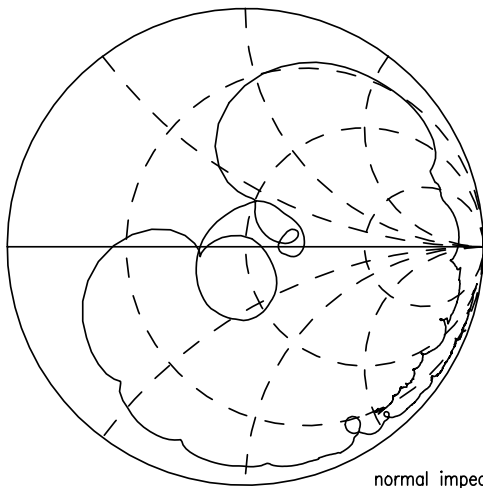

normal impedance: 100.00 Ω

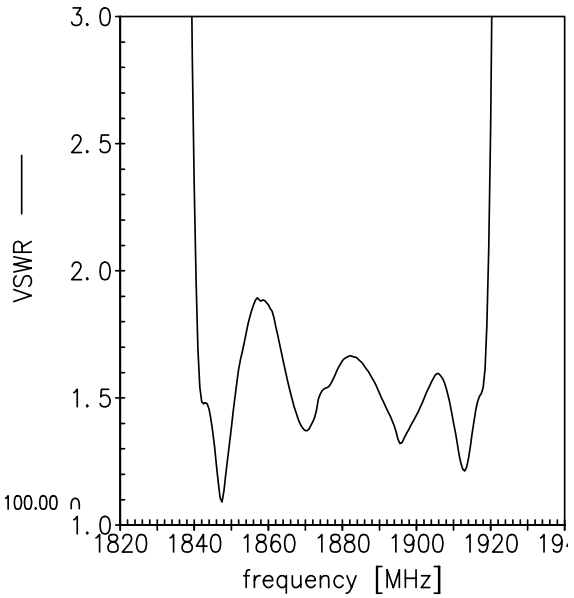

S₂₂ function

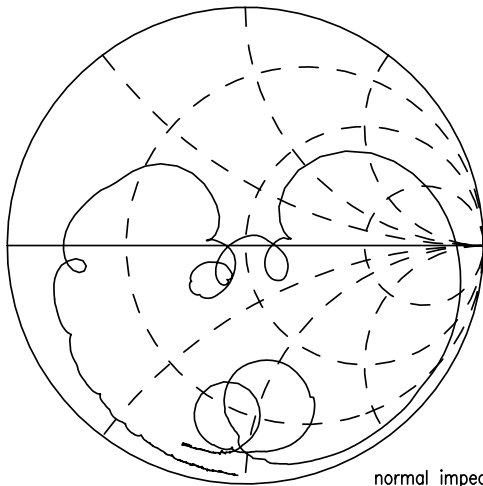

normal impedance: 50.00 Ω

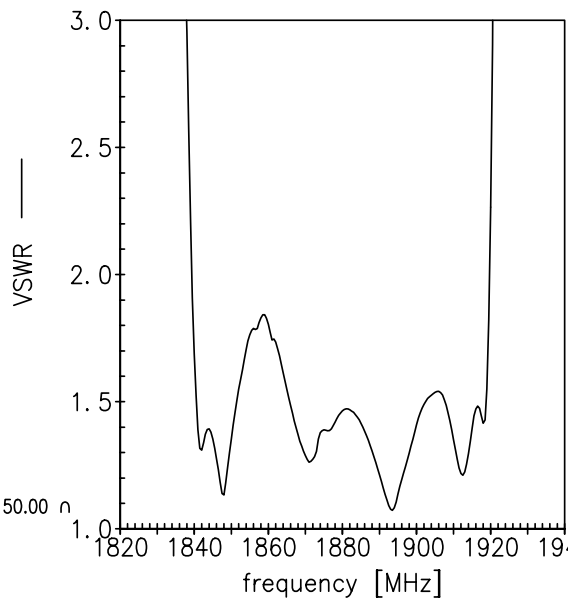



SAW Components

B9312

SAW Tx 2in1 Filter

836.5 / 1880.0 MHz

Data Sheet



References

Type	B9312
Ordering code	B39192B9312N410
Marking and package	C61157-A7-A146
Packaging	F61074-V8152-Z000
Date codes	L_1126
S-parameters	LN55D_band5_NB.s3p, LN55D_band5_WB.s3p LN55D_band2_NB.s3p, LN55D_band2_WB.s3p
Soldering profile	S_6001
RoHS compatible	defined as compatible with the following documents: "DIRECTIVE 2002/95/EC OF THE EUROPEAN PARLIAMENT AND OF THE COUNCIL of 27 January 2003 on the restriction of the use of certain hazardous substances in electrical and electronic equipment. 2005/618/EC from April 18th, 2005, amending Directive 2002/95/EC of the European Parliament and of the Council for the purposes of establishing the maximum concentration values for certain hazardous substances in electrical and electronic equipment."
Moldability	Before using in overmolding environment, please contact your EPCOS sales office.

For further information please contact your local EPCOS sales office or visit our webpage at www.epcos.com .

**Published by EPCOS AG
Surface Acoustic Wave Components Division
P.O. Box 80 17 09, 81617 Munich, GERMANY**

© EPCOS AG 2006. This brochure replaces the previous edition.

For questions on technology, prices and delivery please contact the Sales Offices of EPCOS AG or the international Representatives.

Due to technical requirements components may contain dangerous substances. For information on the type in question please also contact one of our Sales Offices.

Please read *cautions and warnings and important notes* at the end of this document.



Important notes

The following applies to all products named in this publication:

1. Some parts of this publication contain **statements about the suitability of our products for certain areas of application**. These statements are based on our knowledge of typical requirements that are often placed on our products in the areas of application concerned. We nevertheless expressly point out **that such statements cannot be regarded as binding statements about the suitability of our products for a particular customer application**. As a rule, EPCOS is either unfamiliar with individual customer applications or less familiar with them than the customers themselves. For these reasons, it is always ultimately incumbent on the customer to check and decide whether an EPCOS product with the properties described in the product specification is suitable for use in a particular customer application.
2. We also point out that **in individual cases, a malfunction of passive electronic components or failure before the end of their usual service life cannot be completely ruled out in the current state of the art, even if they are operated as specified**. In customer applications requiring a very high level of operational safety and especially in customer applications in which the malfunction or failure of a passive electronic component could endanger human life or health (e.g. in accident prevention or life-saving systems), it must therefore be ensured by means of suitable design of the customer application or other action taken by the customer (e.g. installation of protective circuitry or redundancy) that no injury or damage is sustained by third parties in the event of malfunction or failure of a passive electronic component.
3. The warnings, cautions and product-specific notes must be observed.
4. In order to satisfy certain technical requirements, **some of the products described in this publication may contain substances subject to restrictions in certain jurisdictions (e.g. because they are classed as "hazardous")**. Useful information on this will be found in our Material Data Sheets on the Internet (www.epcos.com/material). Should you have any more detailed questions, please contact our sales offices.
5. We constantly strive to improve our products. Consequently, **the products described in this publication may change from time to time**. The same is true of the corresponding product specifications. Please check therefore to what extent product descriptions and specifications contained in this publication are still applicable before or when you place an order. We also **reserve the right to discontinue production and delivery of products**. Consequently, we cannot guarantee that all products named in this publication will always be available.
6. Unless otherwise agreed in individual contracts, **all orders are subject to the current version of the "General Terms of Delivery for Products and Services in the Electrical Industry" published by the German Electrical and Electronics Industry Association (ZVEI)**.
7. The trade names EPCOS, CeraDiode, CSSP, PhaseCap, PhaseMod, SIFI, SIKOREL, Silver-Cap, SIMID, SIOV, SIP5D, SIP5K, TOPcap, UltraCap, WindCap are **trademarks registered or pending** in Europe and in other countries. Further information will be found on the Internet at www.epcos.com/trademarks.