

FEATURES

TNFE LCD DISPLAY TECHNOLOGY

- Ultra low Power Consumption
- Excellent Readability in Direct Sunlight
- Flexible Format/Custom Capability
- CMOS/TTL Compatible Drive Levels
- Wide Selection of Viewing Modes and Interconnect options
- Wide Temperature Range (-40°C to $+104^{\circ}\text{C}$, Direct Drive)

LXD CONTRIBUTIONS

- Excellent Viewing Angle & Contrast Ratio
- High Reliability, Long Life LCD's & Superior Quality Levels
- Fast Response Times at Low Temperatures
- State-of-the-Art Array Process Manufacturing Techniques
- Very Large Area Displays—VLAD's

APPLICATIONS

Gasoline Pumps
 Navigation Equipment
 Military Equipment
 Commercial Signs
 Automotive
 Industrial Equipment
 Medical Instruments
 Telecommunication Equipment
 Vending Machines
 Consumer Products

LXD offers displays for Indoor and Outdoor use. Outdoor displays feature wide temperature range direct drive or multiplex fluids, high stability polarizers and a protective RTV coating on the contact ledge of pin type LCD's. The outdoor display options assure reliable operation and safe storage in the harshest of environmental conditions. A display option providing compliance with JEDEC Class 4 and MIL-STD-810C requirements is available.

Marine Instruments
 Utility Metering
 Agrionics & Transportation
 Avionics & Aerospace
 Drilling Monitors
 Measuring Instruments
 Sales Terminals
 Computer Peripheral
 Business Equipment
 Weighing Systems

HOW TO USE THIS CATALOG

This catalog contains LCD technology information, standard LCD illustrations, performance specifications, functional descriptions and ordering information for LXD's liquid crystal displays.

The adjacent table of contents will help you find the products and information you want.

EXAMPLE: Let's assume that we want to select a reflective 4.0 Digit (.5") standard direct drive DIL LCD for use in a high stress (high temperature, high humidity) military application, where fast response time at low temperatures is a critical consideration. Also assume that the intended use is in a portable battery operated instrument, where low power consumption and sunlight readability are important requirements.

Step #1: Find the standard model under Direct Drive LCD's (pages 2-11). This is easy to do because the displays are listed in this catalog first by the number of characters or digits (2, 3, 3.5, 4, 4.5, 5, 6, 8, etc.) and secondly by digit height (.35", .50", .70", and 1.0"). The standard LXD Model #44 is illustrated on page 5.

Step #2: Select a fluid type using the Fluid Performance Specification data on page 16. Either the -40°C to $+85^{\circ}\text{C}$ type or the -40°C to $+94^{\circ}\text{C}$ fluid is suitable for outdoor use; however, since fast response time is critical, we select the somewhat more expensive fluid with the -40°C to $+104^{\circ}\text{C}$ temperature range. This fluid is excellent for very thin, fast response displays.

Step #3: Select a viewing mode using the information on pages 18 and 19. We want to select a combination of high stability polarizers and aluminum reflector for use in a high temperature, high humidity environment. We also select the positive image reflective viewing mode for the best readability in direct sunlight and because battery life is important.

Step #4: Select an interconnect option from the illustrations on page 20. This will be LXD DIL PINS with RTV on the contact ledges, which offers the highest reliability in harsh environments.

Step #5: Refer to the Part Numbering System on page 17 and construct the corresponding LXD P/N 44R6R03FGH or LXD P/N 44R6R03FGHJ where the "J" suffix specifies the JEDEC Class 4, MIL-STD-810C option.

Step #6: Call your authorized LXD Factory Representative or an LXD Customer Service Specialist to obtain quantity pricing and delivery information and place your LCD order.

The LXD Factory Representative in your area and Customer Service Specialists and Applications Engineers at the factory are also available to assist you with your special requirements not covered by standard options.

DIRECT DRIVE DISPLAYS

Part #29
Glass Code #19

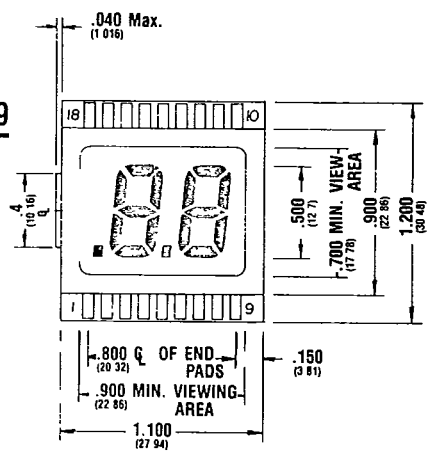

PINOUT: #29, #28

PIN#	SEG	PIN#	SEG
1	BP	18	BP
2	DP	17	G2
3	E2	16	F2
4	D2	15	A2
5	C2	14	B2
6	DP	13	G1
7	E1	12	F1
8	D1	11	A1
9	C1	10	B1

Part #28
Glass Code #24

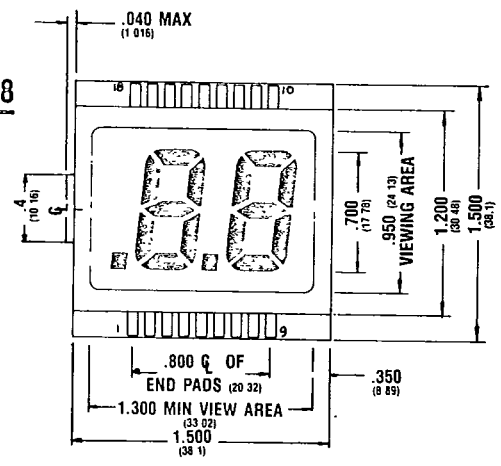

Part #30
Glass Code #99

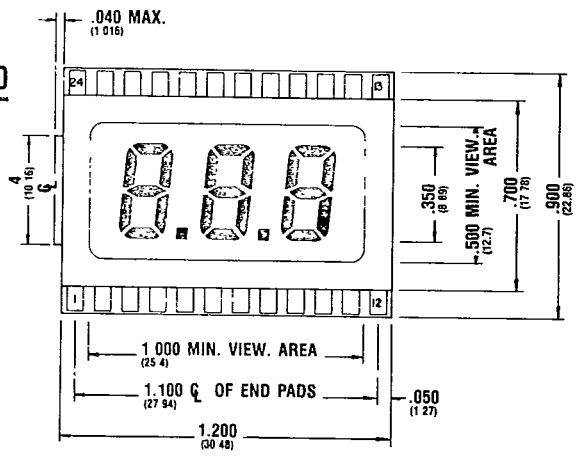

PINOUT: #30

PIN#	SEG	PIN#	SEG
1	E3	24	BP
2	D3	23	G3
3	C2	22	F3
4	DP	21	A3
5	E2	20	B3
6	D2	19	G2
7	C2	18	F2
8	DP	17	A2
9	E1	16	B2
10	D1	15	G1
11	C1	14	F1
12	B1	13	A1

Part #58
Glass Code #79

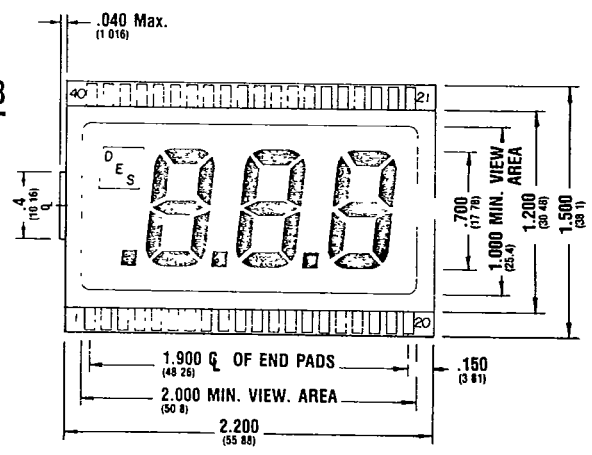

PINOUT: #58, #81

PIN#	SEG	PIN#	SEG
1	BP	40	BP
2	NC	39	DES
3	NC	38	NC
4	NC	37	NC
5	NC	36	NC
6	NC	35	NC
7	NC	34	NC
8	DP	33	NC
9	E3	32	G3
10	D3	31	F3
11	C3	30	A3
12	DP	29	B3
13	E2	28	NC
14	D2	27	G2
15	C2	26	F2
16	DP	25	A2
17	E1	24	B2
18	D1	23	G1
19	C1	22	F1
20	B1	21	A1

Part #81
Glass Code #99

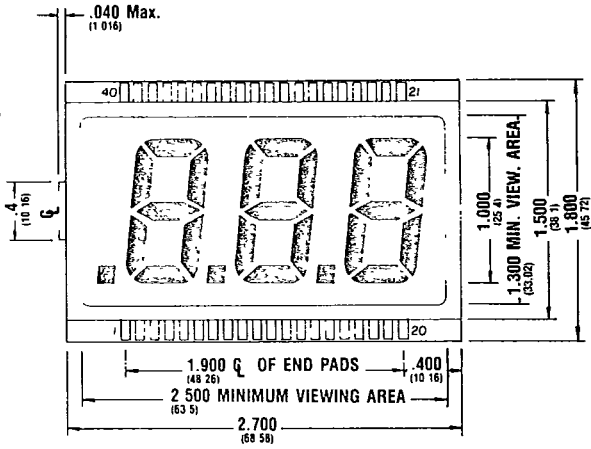

Part #33
Glass Code #02

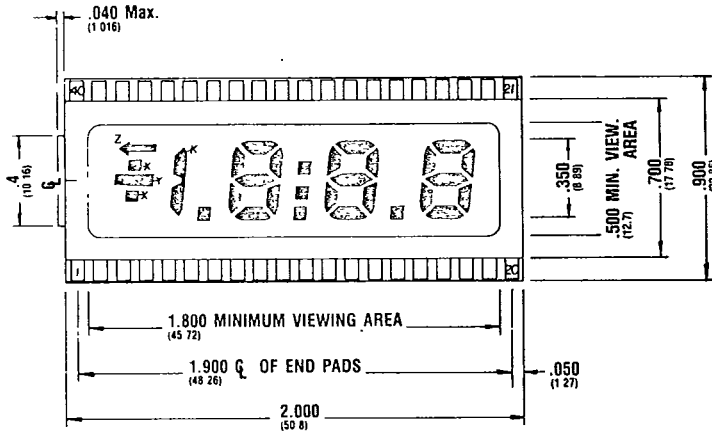

PINOUT: #33, #41, #43
#51, #53, #83

PIN#	SEG	PIN#	SEG
1	BP	40	BP
2	Y	39	X
3	K	38	Z
4	NC	37	NC
5	NC	36	NC
6	NC	35	NC
7	NC	34	NC
8	DP	33	NC
9	E3	32	G3
10	D3	31	F3
11	C3	30	A3
12	DP	29	B3
13	E2	28	COLON
14	D2	27	G2
15	C2	26	F2
16	DP	25	A2
17	E1	24	B2
18	D1	23	G1
19	C1	22	F1
20	B1	21	A1

Part #41
Glass Code #03

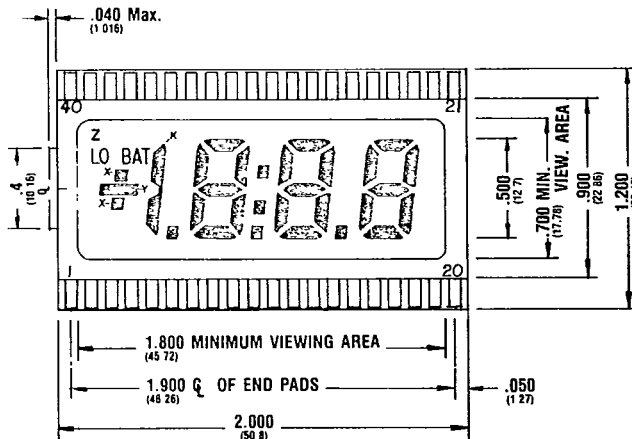

Part #43
Glass Code #03

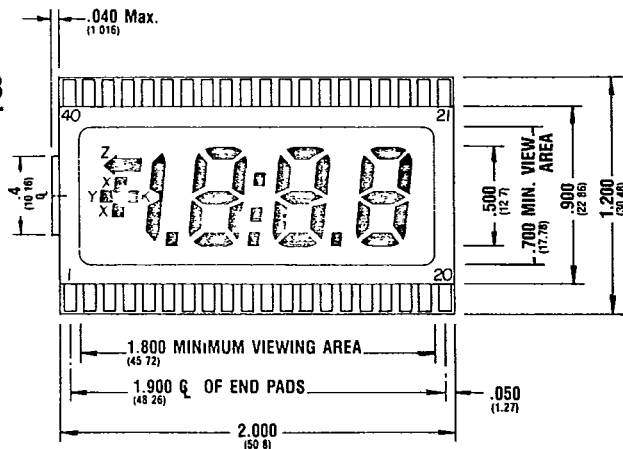

DIRECT DRIVE DISPLAYS

Part #51
Glass Code #08

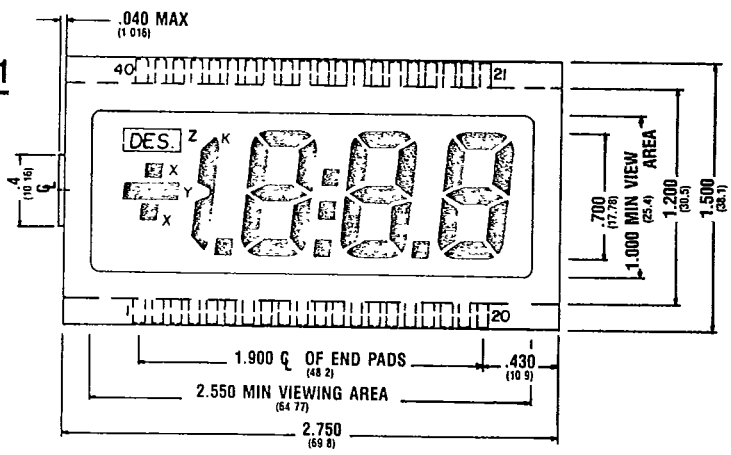

PINOUT: #33, #41, #43, #51, #53, #83

PIN#	SEG	PIN#	SEG
1	BP	40	BP
2	Y	39	X
3	K	38	Z
4	NC	37	NC
5	NC	36	NC
6	NC	35	NC
7	NC	34	NC
8	DP	33	NC
9	E3	32	G3
10	D3	31	F3
11	C3	30	A3
12	DP	29	B3
13	E2	28	COLON
14	D2	27	G2
15	C2	26	F2
16	DP	25	A2
17	E1	24	B2
18	D1	23	G1
19	C1	22	F1
20	B1	21	A1

Part #53
Glass Code #08

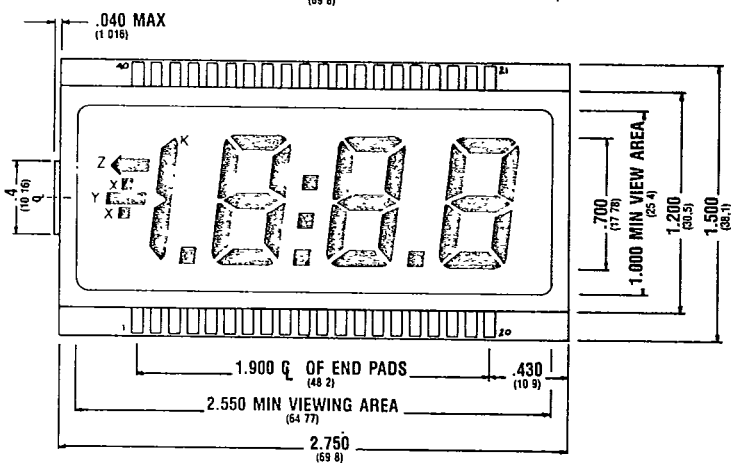

Part #83
Glass Code #11

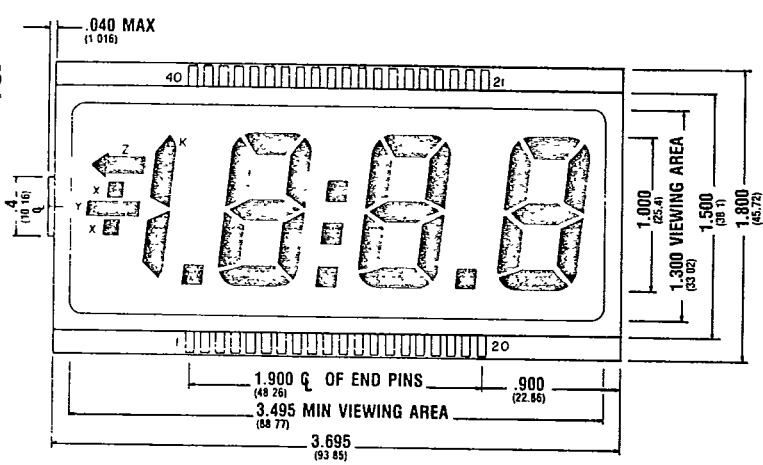

PINOUT: #34, #44, #54, #84

PIN#	SEG	PIN#	SEG
1	BP	40	BP
2	NC	39	NC
3	NC	38	NC
4	NC	37	G4
5	E4	36	F4
6	D4	35	A4
7	C4	34	B4
8	DP	33	NC
9	E3	32	G3
10	D3	31	F3
11	C3	30	A3
12	DP	29	B3
13	E2	28	COLON
14	D2	27	G2
15	C2	26	F2
16	DP	25	A2
17	E1	24	B2
18	D1	23	G1
19	C1	22	F1
20	B1	21	A1

Part #34
Glass Code #02

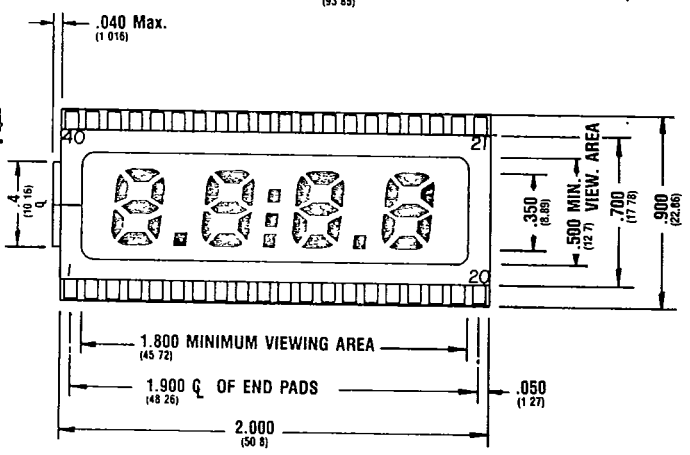

Part #44
Glass Code #03

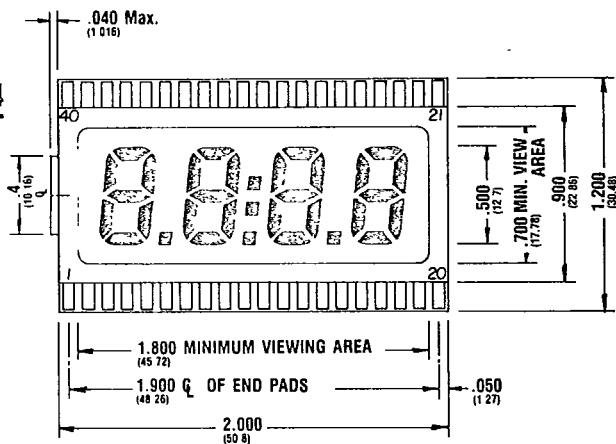

Part #54
Glass Code #08

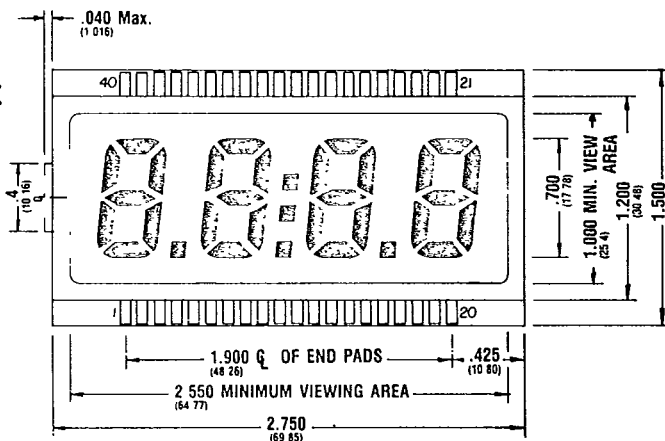

Part #84
Glass Code #11

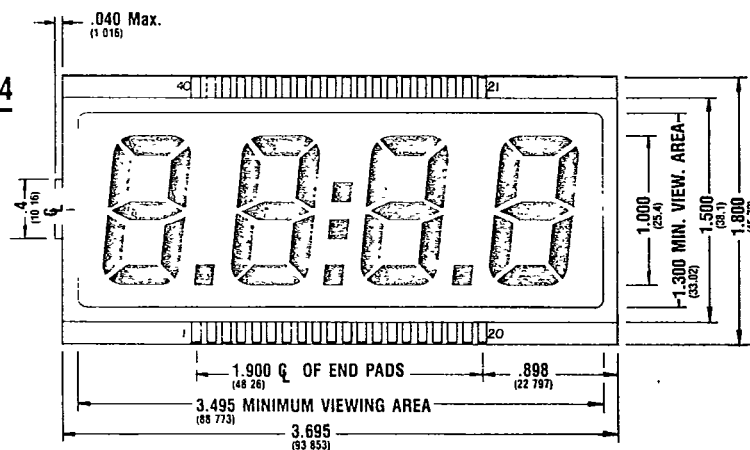

Part #35
Glass Code #02

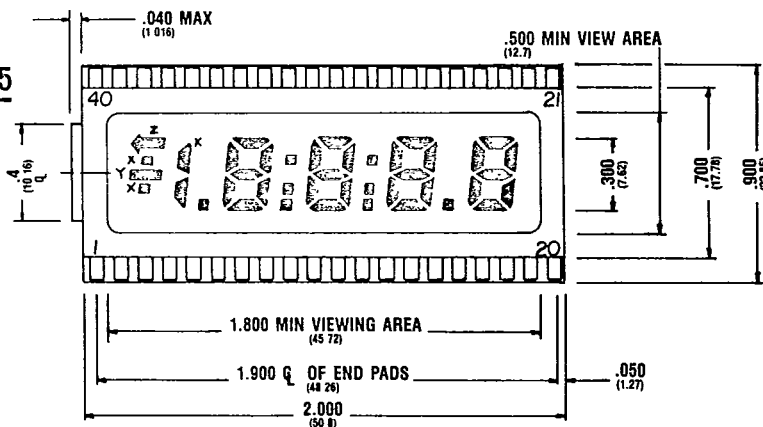

PINOUT: #35, #45, #49, #55, #05

PIN#	SEG	PIN#	SEG
1	BP	40	BP
2	Y	39	X
3	K	38	Z
4	DP	37	G4
5	E4	36	F4
6	D4	35	A4
7	C4	34	B4
8	DP	33	COLON
9	E3	32	G3
10	D3	31	F3
11	C3	30	A3
12	DP	29	B3
13	E2	28	COLON
14	D2	27	G2
15	C2	26	F2
16	DP	25	A2
17	E1	24	B2
18	D1	23	G1
19	C1	22	F1
20	B1	21	A1

DIRECT DRIVE DISPLAYS

Part #45

Glass Code #03

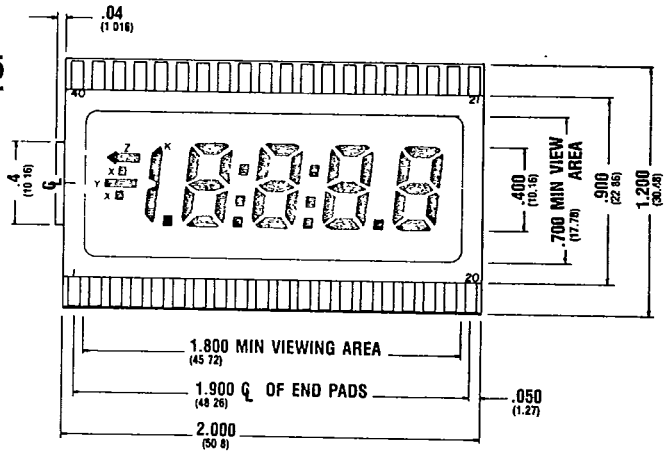

PINOUT: #35, #45, #49, #55, #85

PIN#	SEG	PIN#	SEG
1	BP	40	BP
2	Y	39	X
3	K	38	Z
4	DP	37	G4
5	E4	36	F4
6	D4	35	A4
7	C4	34	B4
8	DP	33	COLON
9	E3	32	G3
10	D3	31	F3
11	C3	30	A3
12	DP	29	B3
13	E2	28	COLON
14	D2	27	G2
15	C2	26	F2
16	DP	25	A2
17	E1	24	B2
18	D1	23	G1
19	C1	22	F1
20	B1	21	A1

Part #49

Glass Code #03

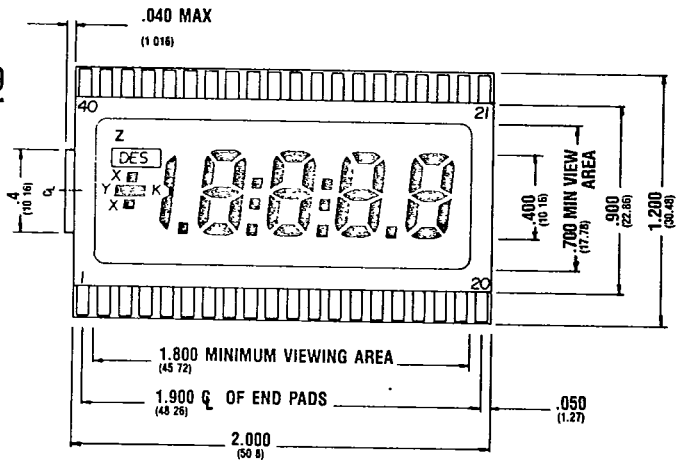

Part #55

Glass Code #08

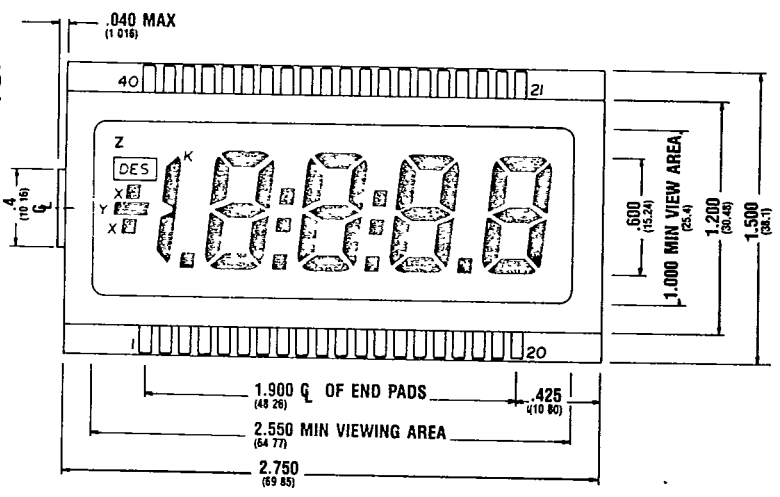

Part #85

Glass Code #11

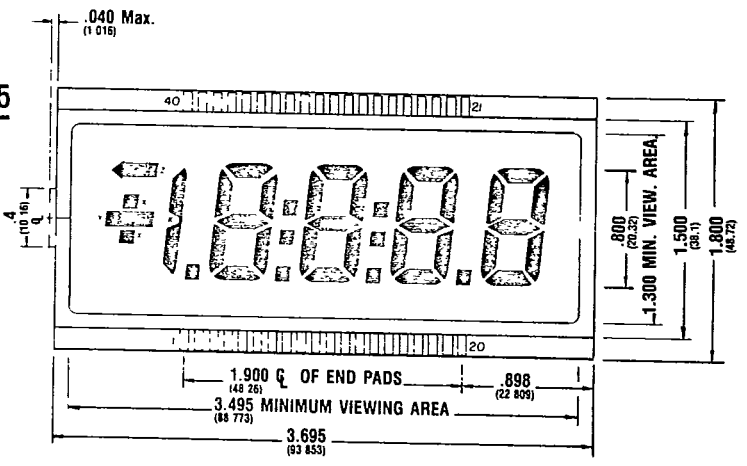

32E D 5306406 000362 8 LXD

L X D INC

Part #47
Glass Code #03

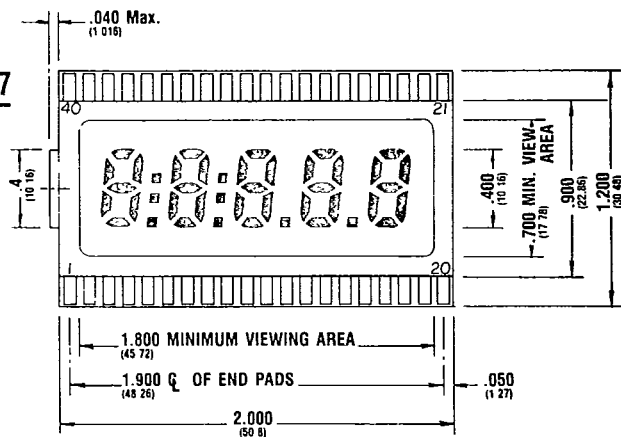

PINOUT: #47

PIN#	SEG	PIN#	SEG
1	BP	40	F5
2	G5	39	A5
3	E5	38	B5
4	D5	37	COLON
5	C5	36	G5
6	E4	35	F4
7	D4	34	A4
8	C4	33	B4
9	E3	32	COLON
10	D3	31	G3
11	C3	30	F3
12	DP	29	A3
13	E2	28	B3
14	D2	27	G2
15	C2	26	F2
16	DP	25	A2
17	E1	24	B2
18	D1	23	G1
19	C1	22	F1
20	B1	21	A1

Part #57
Glass Code #21

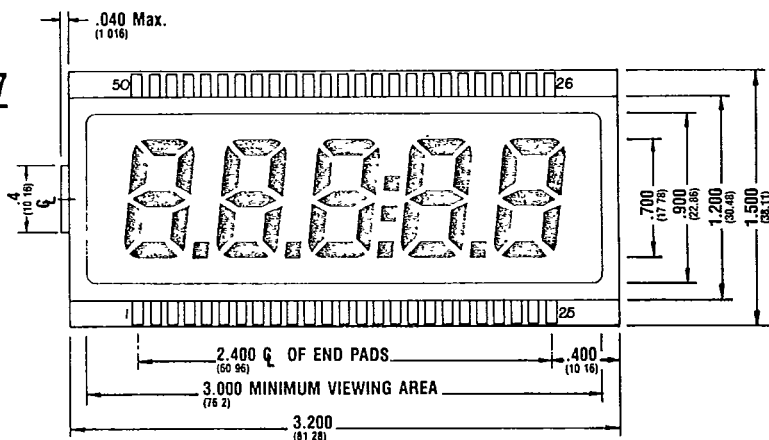

PINOUT: #57

PIN#	SEG	PIN#	SEG
1	BP	50	BP
2	NC	49	NC
3	NC	48	NC
4	NC	47	NC
5	NC	46	G5
6	E5	45	F5
7	D5	44	A5
8	C5	43	B5
9	DP	42	NC
10	E4	41	G4
11	D4	40	F4
12	C4	39	A4
13	DP	38	B4
14	E3	37	G3
15	D3	36	F3
16	C3	35	A3
17	DP	34	B3
18	E2	33	COLON
19	D2	32	G2
20	C2	31	F2
21	DP	30	A2
22	E1	29	B2
23	D1	28	G1
24	C1	27	F1
25	B1	26	A1

DIRECT DRIVE DISPLAYS

5306406 0000363 T ■ LX D

32E D

L X D INC

DIRECT DRIVE DISPLAYS

Part #87
Glass Code #84

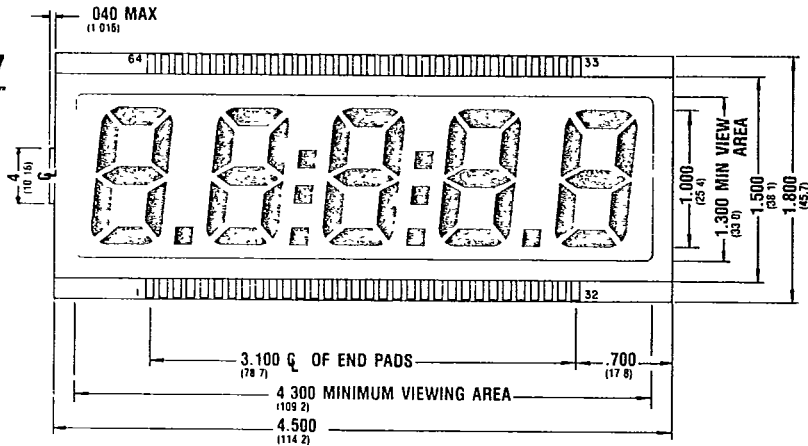

PINOUT: #87

PIN#	SEG	PIN#	SEG
1	BP	64	BP
2	E5	63	G5
3	D5	62	F5
4	C5	61	A5
5	DP	60	B5
6	E4	59	G4
7	NC	58	F4
8	NC	57	NC
9	D4	56	NC
10	C4	55	A4
11	NC	54	B4
12	DP	53	NC
13	NC	52	COLON
14	E3	51	G3
15	NC	50	F3
16	NC	49	NC
17	NC	48	NC
18	D3	47	NC
19	C3	46	A3
20	DP	45	B3
21	NC	44	COLON
22	NC	43	G2
23	E2	42	F2
24	NC	41	NC
25	D2	40	NC
26	C2	39	A2
27	NC	38	B2
28	DP	37	NC
29	E1	36	NC
30	D1	35	G1
31	C1	34	F1
32	B1	33	A1

T-41-38

32E D 5306406 0000364 J LXD

Part #36
Glass Code #37

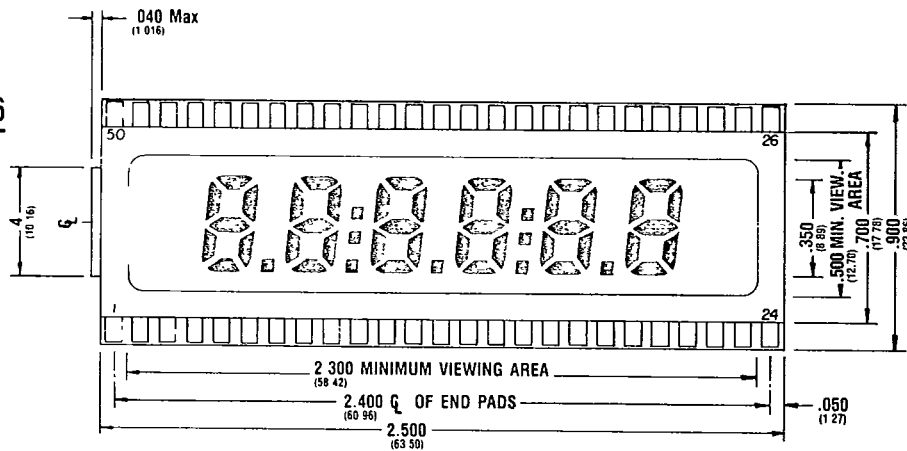

PINOUT: #36, #60, #70

PIN#	SEG	PIN#	SEG
1	BP	50	G6
2	E6	49	F6
3	D6	48	A6
4	C6	47	B6
5	DP	46	G5
6	E5	45	F5
7	D5	44	A5
8	C5	43	B5
9	DP	42	COLON
10	E4	41	G4
11	D4	40	F4
12	C4	39	A4
13	DP	38	B4
14	E3	37	G3
15	D3	36	F3
16	C3	35	A3
17	DP	34	B3
18	E2	33	COLON
19	D2	32	G2
20	C2	31	F2
21	DP	30	A2
22	E1	29	B2
23	D1	28	G1
24	C1	27	F1
25	B1	26	A1

L X D INC

Part #60
Glass Code #05

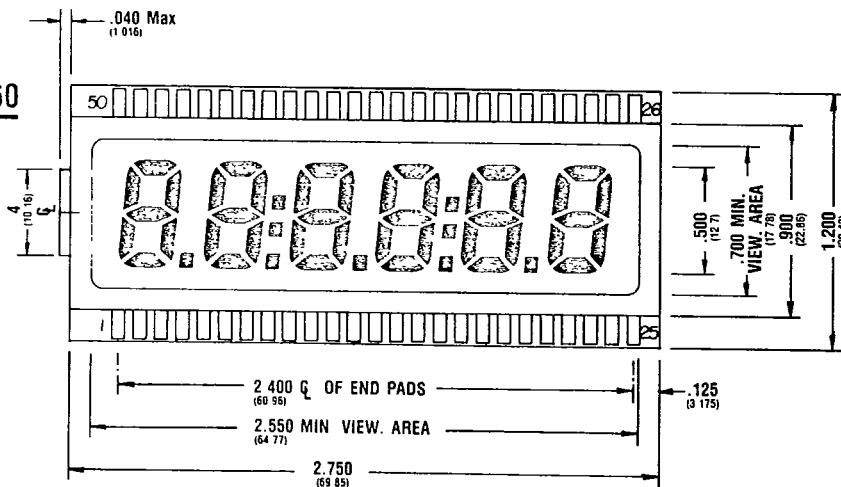

Part #70

Glass Code #99

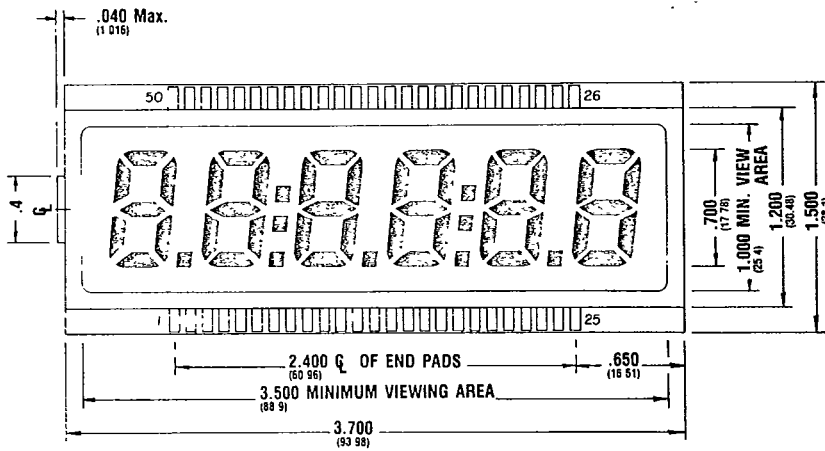

Part #90

Glass Code #99

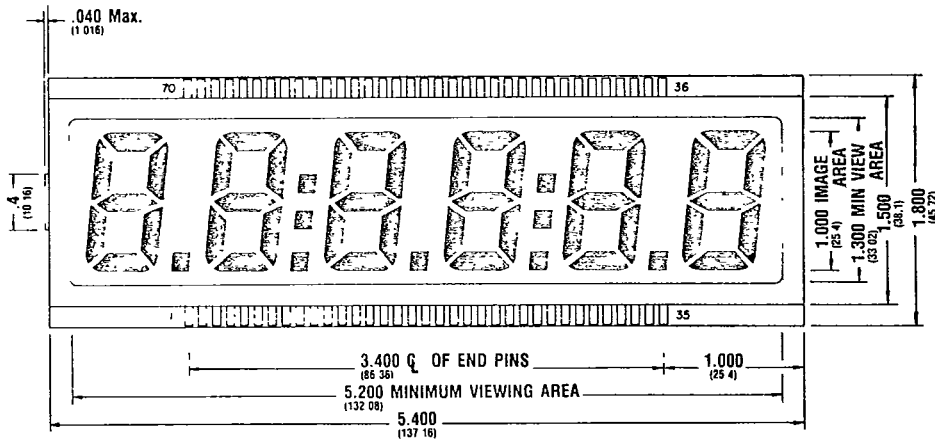

PINOUT: #90

PIN#	SEG	PIN#	SEG
1	BP	70	BP
2	E6	69	G6
3	D6	68	F6
4	C6	67	A6
5	DP	66	B6
6	E5	65	G5
7	D5	64	F5
8	C5	63	A5
9	DP	62	B5
10	E4	61	COLON
11	D4	60	G4
12	NC	59	F4
13	NC	58	A4
14	NC	57	NC
15	NC	56	NC
16	C4	55	B4
17	NC	54	NC
18	DP	53	NC
19	E3	52	G3
20	D3	51	F3
21	NC	50	A3
22	NC	49	NC
23	NC	48	NC
24	C3	47	NC
25	NC	46	B3
26	DP	45	NC
27	E2	44	COLON
28	D2	43	G2
29	NC	42	F2
30	NC	41	A2
31	C2	40	B2
32	DP	39	G1
33	E1	38	F1
34	D1	37	A1
35	C1	36	B1

DIRECT DRIVE DISPLAYS

Part #65

Glass Code #09

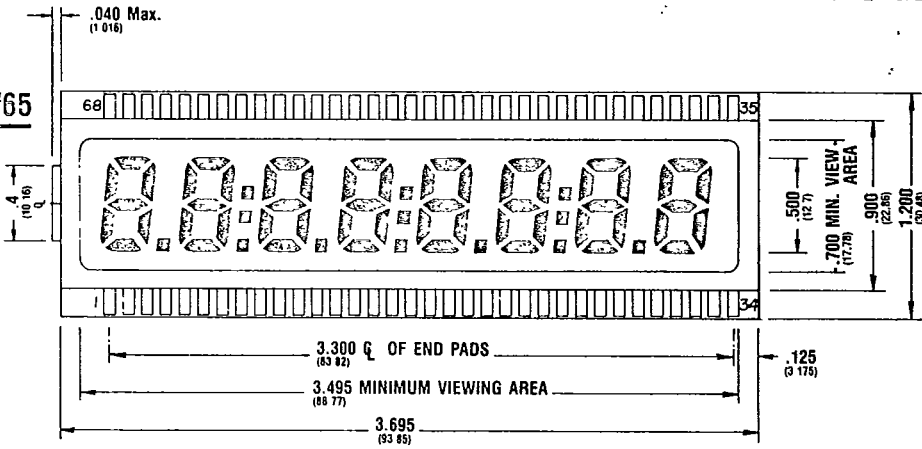

PINOUT: #65

PIN#	SEG	PIN#	SEG
1	BP	68	G8
2	E8	67	F8
3	D8	66	A8
4	C8	65	B8
5	DP	64	G7
6	E7	63	F7
7	D7	62	A7
8	C7	61	B7
9	DP	60	COLON
10	NC	59	G6
11	E6	58	F6
12	D6	57	A6
13	C6	56	B6
14	DP	55	G5
15	E5	54	F5
16	D5	53	A5
17	C5	52	B5
18	DP	51	COLON
19	E4	50	G4
20	D4	49	F4
21	C4	48	A4
22	DP	47	B4
23	E3	46	G3
24	D3	45	F3
25	C3	44	A3
26	DP	43	B3
27	E2	42	COLON
28	D2	41	G2
29	C2	40	F2
30	DP	39	A2
31	E1	38	B2
32	D1	37	G1
33	C1	36	F1
34	B1	35	A1

Part #91

Glass Code #011

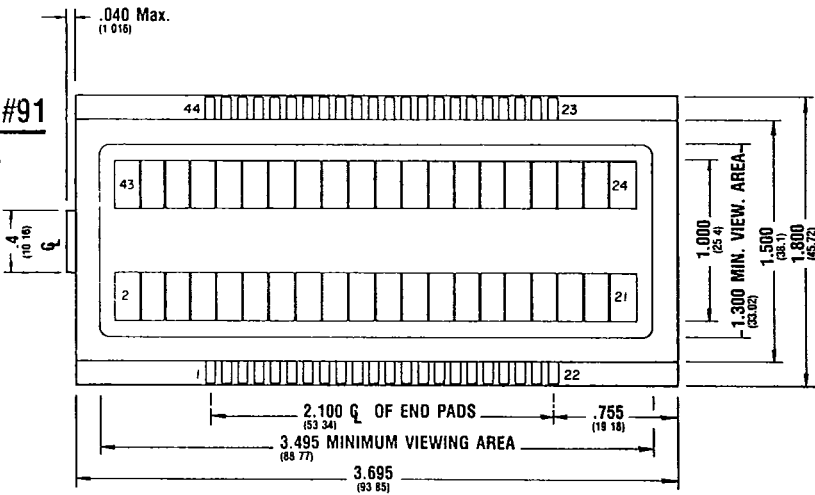

PINOUT: #91

PIN#	SEG	PIN#	SEG
1	BP	44	BP
2	2	43	43
3	3	42	42
4	4	41	41
5	5	40	40
6	6	39	39
7	7	38	38
8	8	37	37
9	9	36	36
10	10	35	35
11	11	34	34
12	12	33	33
13	13	32	32
14	14	31	31
15	15	30	30
16	16	29	29
17	17	28	28
18	18	27	27
19	19	26	26
20	20	25	25
21	21	24	24
22	BP	23	BP

Part #78
Glass
Code
#10

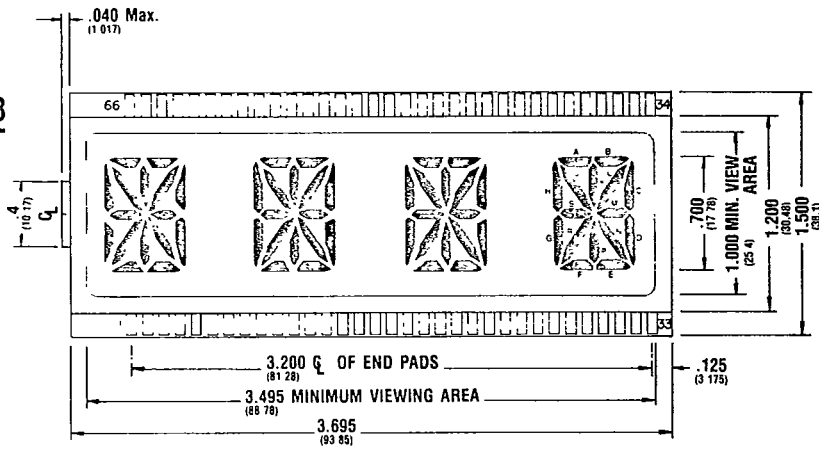

PINOUT: #78

PIN#	SEG	PIN#	SEG
1	G4	66	S4
2	R4	65	H4
3	F4	64	J4
4	P4	63	A4
5	E4	62	K4
6	N4	61	B4
7	D4	60	L4
8	M4	59	C4
9	G3	58	S3
10	R3	57	H3
11	F3	56	J3
12	P3	55	A3
13	E3	54	K3
14	N3	53	B3
15	D3	52	L3
16	M3	51	C3
17	G2	50	S2
18	R2	49	H2
19	F2	48	J2
20	P2	47	A2
21	E2	46	K2
22	N2	45	B2
23	D2	44	L2
24	M2	43	C2
25	G1	42	S1
26	R1	41	H1
27	F1	40	J1
28	P1	39	A1
29	E1	38	K1
30	N1	37	B1
31	D1	36	L1
32	M1	35	C1
33	BP	34	BP

Part #353

Glass Code #03

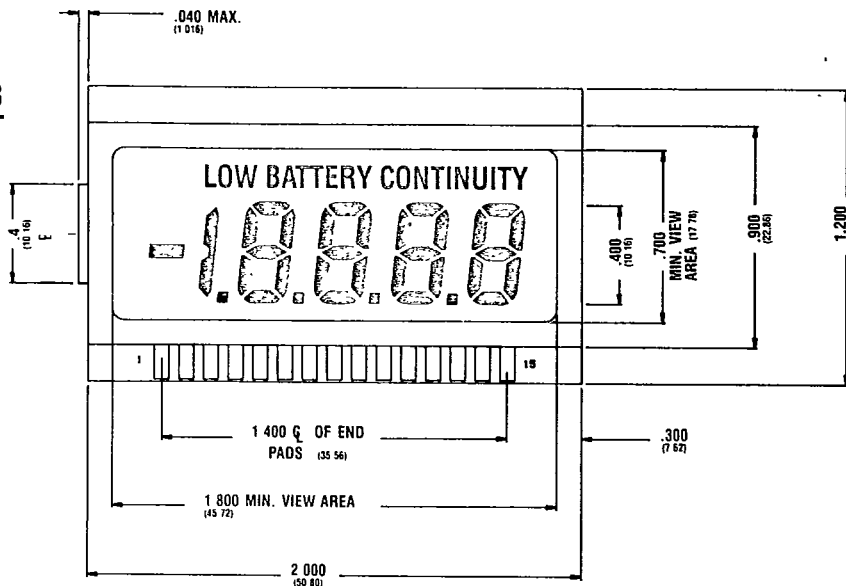

PINOUT: #353

PAD	1	2	3	4	5	6	7	8	9	10	11	12	13	14	15
BP 1	F4	A4	B4	F3	A3	B3	F2	A2	B2	F1	A1	B1	BP1	-	-
BP 2	E4	G4	C4	E3	G3	C3	E2	G2	C2	E1	G1	C1	-	BP2	-
BP 3	DP	D4	ONE	DP	D3	MINUS	D2	LOBAT	DP	D1	CONT	-	-	-	BP3

Part #38

Glass Code #02

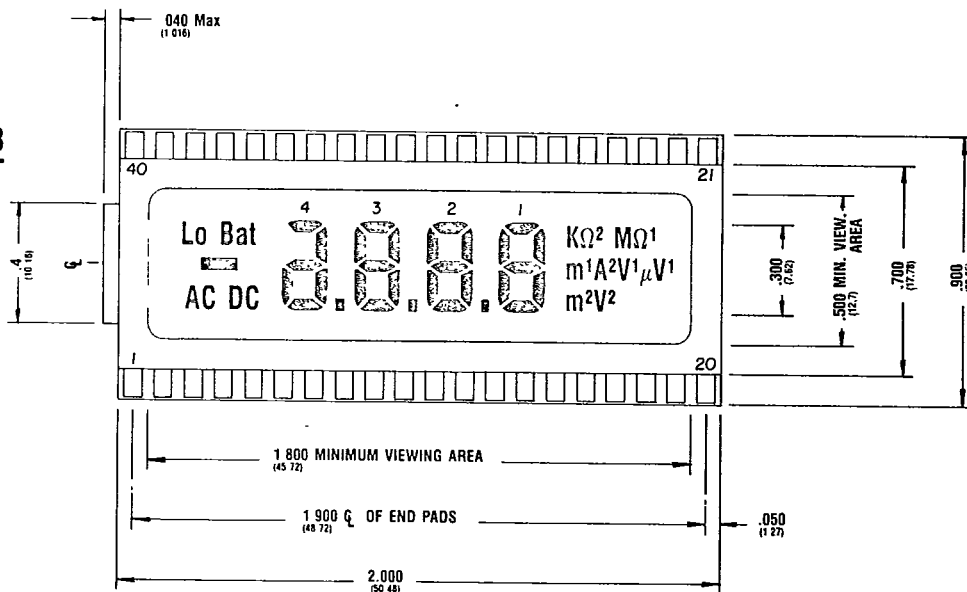

PINOUT: #38

PIN#	CP1	CP2	PIN#	CP1	CP2
1	-	CP2	21	CP1	-
2	MINUS	AC	22	MΩ¹	μA¹
3	A4,D4,E4,G4	-	23	Ω²	A²
4	-	-	24	K	m¹
5	F3	DP3	25	-	-
6	G3	E3	26	-	-
7	-	D3	27	B1	C1
8	B3	C3	28	A1	-
9	F2	DP2	29	F1	DP1
10	G2	E2	30	B2	C2
11	-	D2	31	A2	-
12	B2	C2	32	F2	DP2
13	F1	DP1	33	B3	C3
14	G1	E1	34	A3	-
15	-	D1	35	F3	DP3
16	B1	C1	36	B4	C4
17	-	m²	37	A4,D4,E4,G4	-
18	-	V²	38	DC	-
19	-	V¹	39	LoBat	-
20	-	CP2	40	CP1	-

GE / INTERSIL NUMBERS DIGITS FROM RIGHT TO LEFT 0,1,2,3.

5306406 0000368 9 LXD

L X D INC

Part #66
Glass
Code
#09

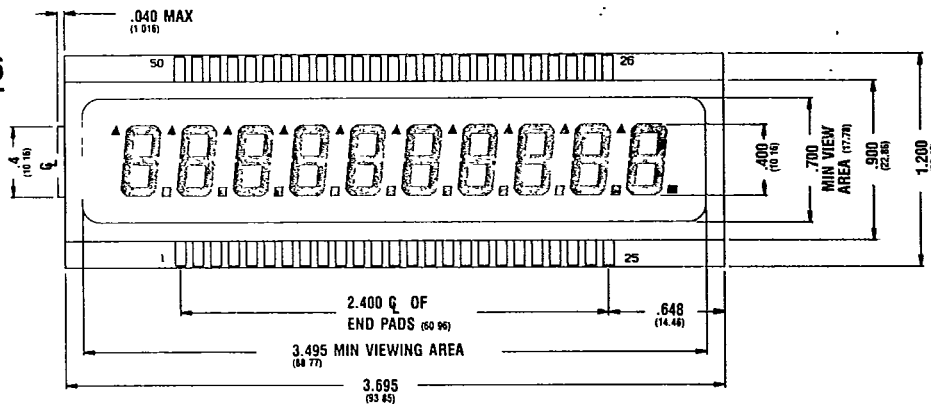

PINOUT: #66

T=TRIANGLE

PAD	50	49	48	47	46	45	44	43	42	41	40	39	38	37	36	35	34	33	32	31	30	29	28	27	26	
BP1	BP1	A10	B10	A9	B9	—	B8	—	—	B7	—	A6	B6	—	A5	B5	—	B4	—	—	B3	A2	B2	B1	—	
BP2	—	G10	C10	G9	C9	—	C8	—	—	C7	—	G6	C6	—	G5	C5	—	C4	—	—	G3	C2	C1	BP2	—	
BP3	—	D10	DP	D9	DP	—	DP	—	—	DP	—	D6	DP	—	D5	DP	—	DP	—	—	DP	D2	DP	DP	—	
BP1	—	T10	T9	T8	A8	—	—	T7	A7	—	T6	—	—	—	T5	—	T4	A4	—	—	T3	A3	—	T2	T1	A1
BP2	—	F10	F9	F8	G8	—	—	F7	G7	—	F6	—	—	—	F5	—	F4	G4	—	—	F3	G3	—	F2	F1	G1
BP3	BP3	E10	E9	E8	D8	—	—	E7	D7	—	E6	—	—	—	E5	—	E4	D4	—	—	E3	D3	—	E2	E1	D1
PAD	1	2	3	4	5	6	7	8	9	10	11	12	13	14	15	16	17	18	19	20	21	22	23	24	25	

Part #69
Glass
Code
#99

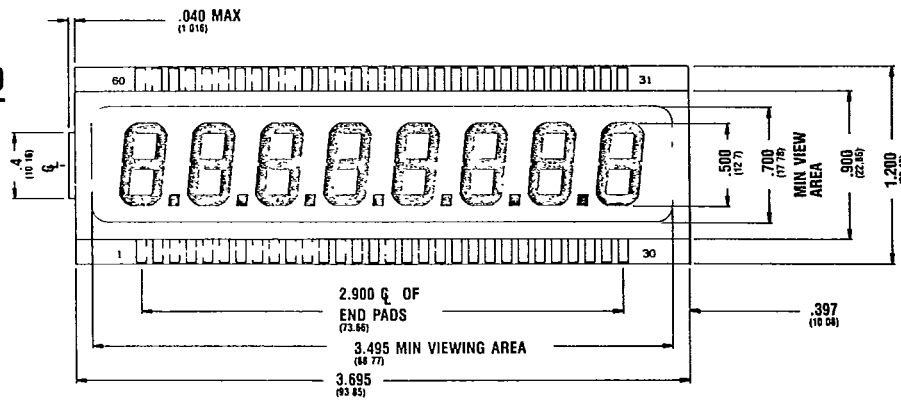

PINOUT: #69

PAD	60	59	58	57	56	55	54	53	52	51	50	49	48	47	46	45	44	43	42	41	40	39	38	37	36	35	34	33	32	31
BP1	BP1	BP1	—	A8	A8	A7	A7	—	A6	A6	—	A5	A5	—	—	A4	A4	—	—	A3	A3	—	—	A2	A2	—	A1	A1	—	—
BP2	—	—	—	B8	B8	B7	B7	—	B6	B6	—	B5	B5	—	—	B4	B4	—	—	B3	B3	—	—	B2	B2	—	B1	B1	BP2	BP2
BP3	—	—	—	C8	C8	C7	C7	—	C6	C6	—	C5	C5	—	—	C4	C4	—	—	C3	C3	—	—	C2	C2	—	C1	C1	—	—
BP4	—	—	—	DP	DP	DP	DP	—	DP	DP	—	DP	DP	—	—	DP	DP	—	—	DP	DP	—	—	DP	DP	—	DP	DP	—	—
BP1	—	—	—	F8	F8	—	F7	F7	—	F6	F6	—	—	F5	F5	—	—	F4	F4	—	—	F3	F4	F2	F2	—	F1	F1	—	—
BP2	—	—	—	G8	G8	—	G8	G8	—	G6	G6	—	—	G5	G5	—	—	G4	G4	—	—	G3	G3	G2	G2	—	G1	G1	—	—
BP3	BP3	BP3	—	E8	E8	—	E8	E8	—	E6	E6	—	—	E5	E5	—	—	E4	E4	—	—	E3	E3	E2	E2	—	E1	E1	—	—
BP4	—	—	—	D8	D8	—	D8	D8	—	D6	D6	—	—	D5	D5	—	—	D4	D4	—	—	D3	D3	D2	D2	—	D1	D1	BP4	BP4
PAD	1	2	3	4	5	6	7	8	9	10	11	12	13	14	15	16	17	18	19	20	21	22	23	24	25	26	27	28	29	30

ALPHANUMERIC MULTIPLEXED DISPLAYS

Part #77
Glass Code #10

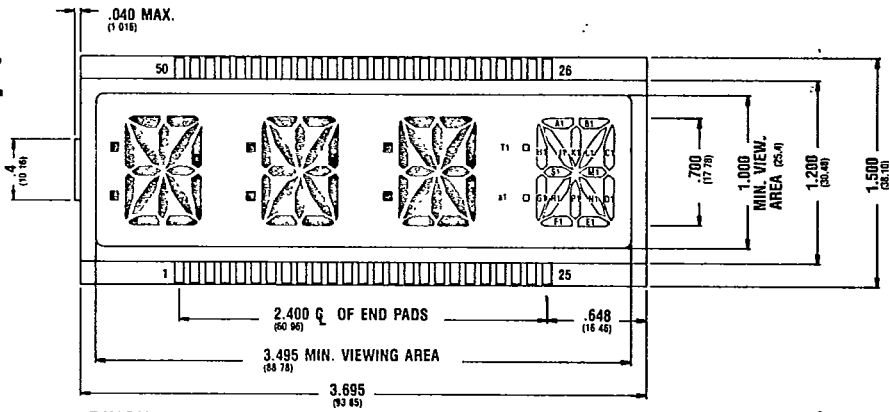

PINOUT: #77

PAD	50	49	48	47	46	45	44	43	42	41	40	39	38	37	36	35	34	33	32	31	30	29	28	27	26
BP1	—	BP1	H4	A4	K4	B4	—	H3	A3	K3	B3	—	—	H2	A2	—	K2	—	B2	—	H1	A1	K1	B1	BP1
BP2	BP2	—	G4	J4	P4	L4	—	G3	J3	P3	L3	—	—	G2	J2	—	P2	—	L2	—	G1	J1	P1	L1	—
BP3	—	—	R4	S4	N4	M4	—	R3	S3	N3	M3	—	—	R2	S2	—	N2	—	M2	—	R1	S1	N1	M1	—
BP1	—	—	T4	C4	—	—	—	T3	—	C3	—	—	—	—	—	—	T2	—	C2	—	T1	C1	—	—	—
BP2	—	—	—	a4	D4	—	—	a3	—	D3	—	—	—	—	—	—	a2	—	D2	—	—	a1	D1	—	BP2
BP3	BP3	—	—	F4	E4	—	—	F3	—	E3	—	—	—	—	—	—	F2	—	E2	—	—	F1	E1	BP3	—
PAD	1	2	3	4	5	6	7	8	9	10	11	12	13	14	15	16	17	18	19	20	21	22	23	24	25

Part #76
Glass Code #99

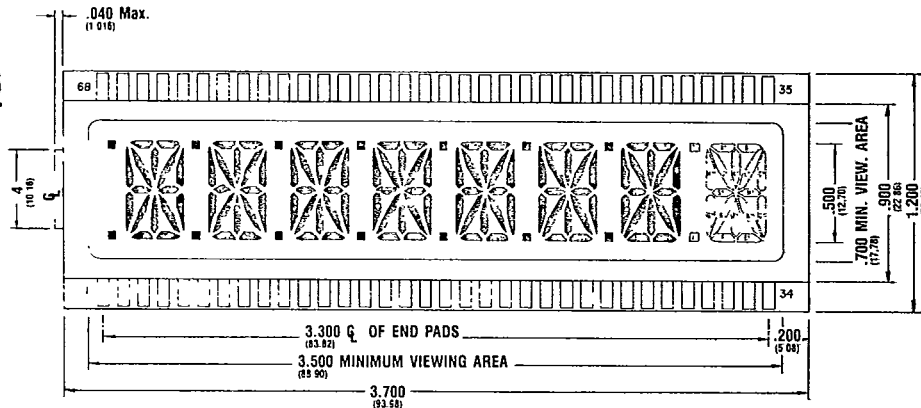

PINOUT: #76

PAD	68	67	66	65	64	63	62	61	60	59	58	57	56	55	54	53	52	51	50	49	48	47	46	45	44	43	42	41	40	39	38	37	36	35	
BP1A	BP1A	H8	A8	K8	B8	H7	A7	K7	B7	H6	A6	K6	B6	H5	A5	K5	B5	H4	A4	K4	B4	H3	A3	K3	B3	H2	A2	K2	B1	H1	A1	K1	B1	BP1B	BP1B
BP2A	—	G8	J8	P8	L8	G7	J7	P7	L7	G6	J6	P6	L6	G5	J5	P5	L5	G4	J4	P4	L4	G3	J3	P3	L3	G2	J2	P2	L2	G1	J1	P1	L1	—	BP2B
BP3A	—	R8	S8	N8	M8	R7	S7	N7	M7	R6	S6	N6	M6	R5	S5	N5	M5	R4	S4	N4	M4	R3	S3	N3	M3	R2	S2	N2	M2	R1	S1	N1	M1	—	BP3B
BP1A	—	—	T8	C8	—	—	T7	C7	—	—	T6	C6	—	—	T5	C5	—	—	T4	C4	—	—	T3	C3	—	—	T2	C1	—	—	T1	C1	—	—	BP1B
BP2A	BP2A	—	a8	D8	—	—	a7	D7	—	—	a6	D6	—	—	a5	D5	—	—	a4	D4	—	—	a3	D3	—	—	a2	D2	—	—	a1	D1	—	BP2B	BP2B
BP3A	—	BP3A	F8	E8	—	—	F7	E7	—	—	F6	E6	—	—	F5	E5	—	—	F4	E4	—	—	F3	E3	—	—	FR	E2	—	—	F1	E1	BP3B	—	BP3B
PAD	1	2	3	4	5	6	7	8	9	10	11	12	13	14	15	16	17	18	19	20	21	22	23	24	25	26	27	28	29	30	31	32	33	34	

Part #350
Glass Code #99

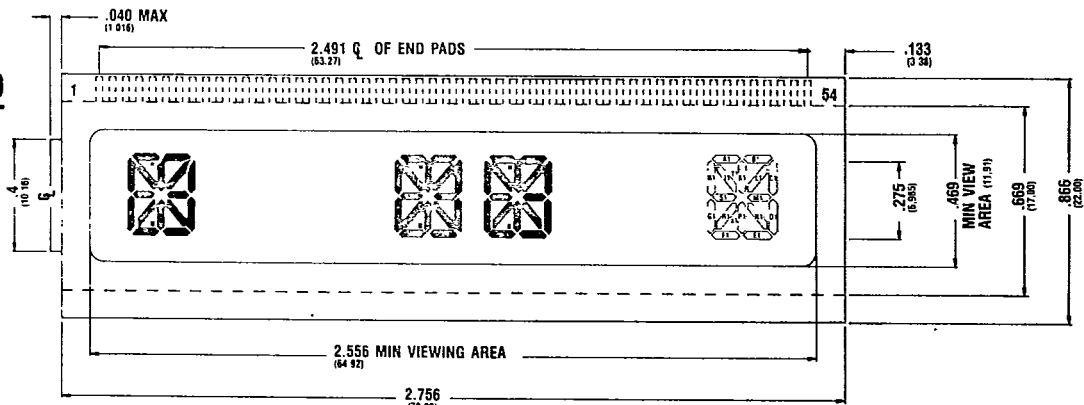

PINOUT: #350

PAD	1	2	3	4	5	6	7	8	9	10	11	12	13	14	15	16	17	18	19	20	21	22	23	24	25	26	27
BP3A	BP3A	—	—	R8	S8	F8	N8	M8	E8	R7	S7	F7	N7	M7	E7	R6	S6	F6	N6	M6	E6	R5	S5	F5	N5	M5	E5
BP2A	—	BP2A	—	G8	J8	a8	P8	L8	D8	G7	J7	a7	P7	L7	D7	G6	J6	a6	P6	L6	D6	G5	J5	a5	P5	L5	D5
BP1A	—	—	BP1A	H8	A8	T8	K8	B8	C8	H7	A7	T7	K7	B7	C7	H6	A6	T6	K6	B6	C6	H5	A5	T5	K5	B5	C5
28	29	30	31	32	33	34	35	36	37	38	39	40	41	42	43	44	45	46	47	48	49	50	51	52	53	54	PAD
R4	S4	F4	N4	M4	E4	R3	S3	F3	N3	M3	E3	R2	S2	F2	N2	M2	E2	R1	S1	F1	N1	M1	E1	—	—	—	BP3B
G4	J4	a4	P4	L4	D4	G3	J3	a3	P3	L3	D3	G2	J2	a2	P2	L2	D2	G1	J1	a1	P1	L1	D1	—	BP2B	—	BP2B
H4	A4	T4	K4	B4	C4	H3	A3	T3	K3	B3	C3	H2	A2	T2	K2	B2	C2	H1	A1	T1	K1	B1	C1	—	—	BP1B	BP1B

32E D 5306406 0000370 ? LXL

L X D INC

Part #93

Glass Code #31

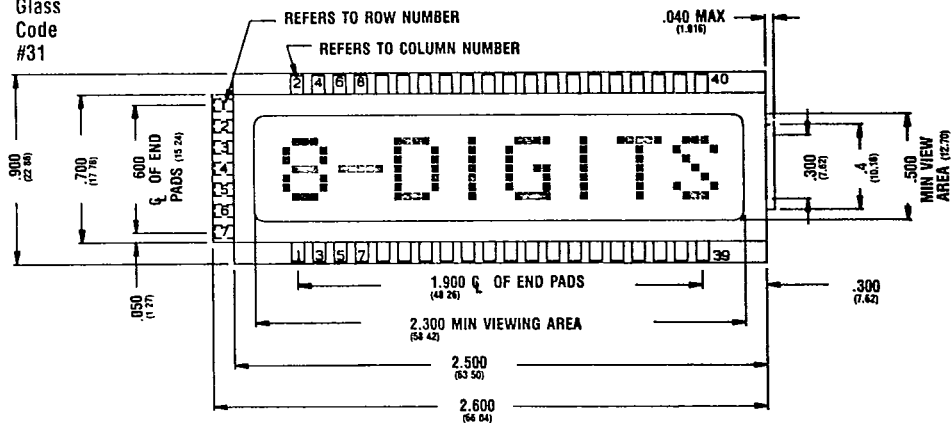

Part #347

Glass Code #99

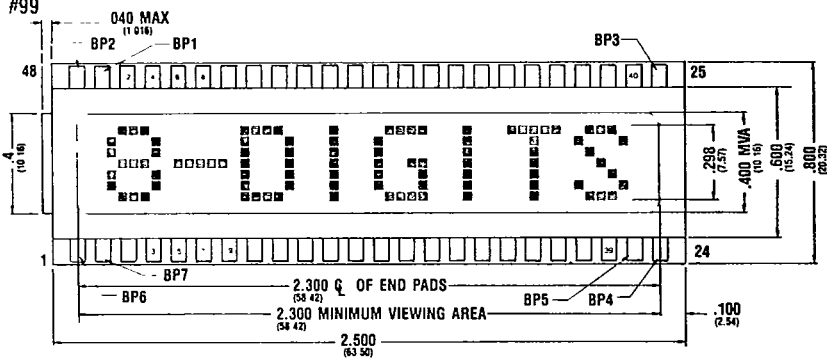

Part #94

Glass Code #32

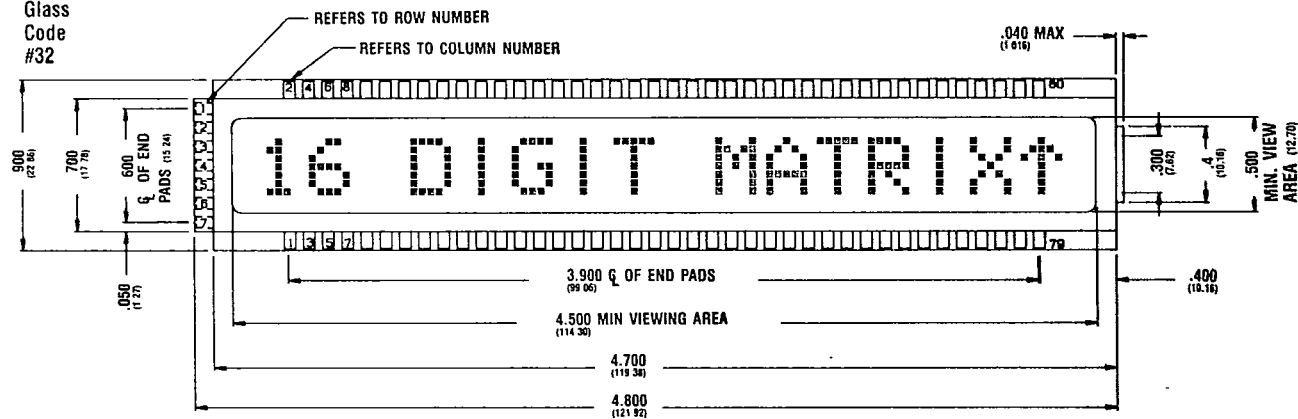

Part #96

Glass Code #33

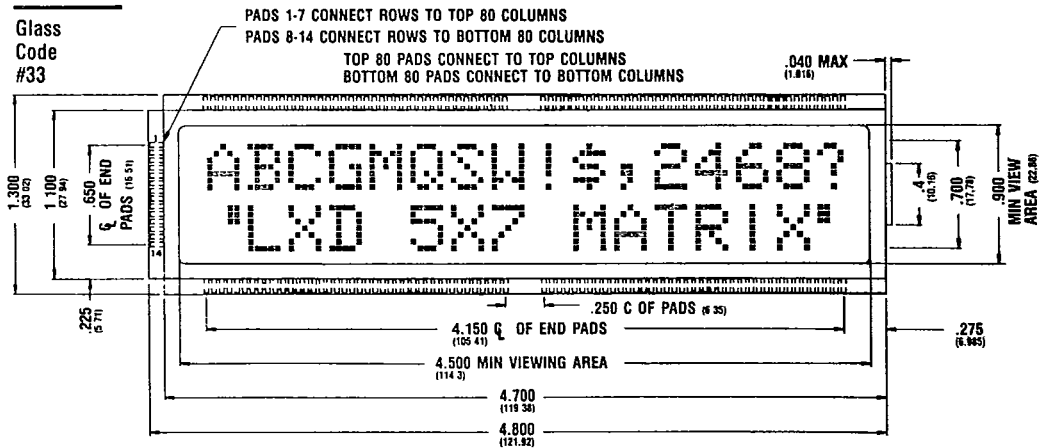

Description of Liquid Crystal Fluid Options

LXD offers five types of standard liquid crystal fluids for use in a wide variety of applications. The primary distinction to be made is Direct Drive (#2, #3, #5, #6, #8) versus "Multiplexable" (#2, #3 and #8). Secondly, we consider temperature range and speed of response at low temperatures. Thirdly, we need to consider drive level requirements and threshold characteristics, especially for multiplexed displays. The following is a brief description of each fluid's key features.

Type #2: This is a very wide temperature range (-40°C to +94°C) direct drive fluid with excellent speed of response characteristics at very low temperatures. It is a very versatile fluid in that it can also be used as a very wide temperature range multiplex fluid for multiplex levels up to 1/12. Multiplexing dictates significantly narrower operating temperature ranges depending upon the degree of thermal compensation in the drive electronics.

Type #3: This is a wide temperature range (-40°C to +85°C) direct drive fluid with good speed of response characteristics at very low temperatures. It is a versatile fluid in that it can also be used as a wide temperature range multiplex fluid for multiplex levels up to 1/12. Multiplexing restricts the operating temperature range.

This is the most economical choice for most outdoor applications, although it is also offered in multiplexed displays with commercial grade polarizers for indoor applications demanding a high threshold fluid.

Type #5: This is our lowest cost, narrow temperature range, direct drive only fluid, which is intended for use in indoor or portable applications, not

requiring storage or operation in high temperature or high humidity environments. It features a relatively low threshold.

Type #6: This is our widest temperature range (-40°C to +104°C) direct drive only fluid for use in outdoor applications. With the fast response wide viewing angle cell spacing option, this fluid provides fast response and extremely wide viewing angle and contrast for applications such as outdoor signs.

#8: This is our low threshold, narrow temperature range, multiplex fluid. It is not offered in direct drive displays because the #5 fluid offers equivalent performance at a lower cost. As a multiplex fluid it can be used up to 1/16 multiplexing with CMOS MUX Drivers operating from a 5.0 volt supply.

Fast Response Wide Viewing Angle

This option is available for most of our standard Liquid Crystal fluids which are typically used in the standard cell spacing devices. This ultra-thin (5 micron or less), precision-controlled cell spacing is assured by our unique array process, materials and assembly methods. The resulting displays feature super fast response times and extraordinary wide viewing angles and contrasts. In theory, the turn-on time of a TNFE LCD is inversely proportional to the square of the cell spacing, so reducing the cell spacing from 8 microns to 4 microns would reduce the turn-on time by a factor of four.

LXD displays having thin cell spacing are designed for maximum contrast ratio and field of view up to 165° included angle.

LIQUID CRYSTAL FLUID OPTIONS

	#2			#3			#5			#6			#8			Unit
	Min	Typ	Max	Min	Typ	Max	Min	Typ	Max	Min	Typ	Max	Min	Typ	Max	
Operating Voltage	4	9	15	4	9	15	3	6	9	4	7	15	3	6	9	Vrms
Operating Freq Range	32	60	100	32	60	100	32	60	100	32	60	100	32	60	100	Hz
Visual Threshold 10% on @ 20C		2.0			2.3			1.5			1.7			1.2		Vrms
90% on @ 20C		2.8			3.2			2.0			2.6			1.9		Vrms
Operating Temp Range	-40		94	-40		85	-10		60	-40		104	-20		61	°C
Storage Temp Range	-55		94	-55		85	-10		60	-55		104	-20		61	°C

LXD's Part Numbering System identifies the many possible options of LXD's standard and custom LCD products. First obtain the basic display type or standard model number from the illustrations on pages 2-15, based upon the desired format and character or digit size. If you cannot find a standard model that will meet your needs, contact LXD's Factory Representative in your area or the Factory direct for a custom quotation.

The Termination/Construction options specify the glass configuration and the connector type. Selection is based upon reliability, cost, and packaging requirements.

The Fluid Type is chosen based upon environmental, cost, electrical drive and response time requirements.

The Polarizer/Reflector Mode is determined by the viewability requirements in various ambient lighting conditions with or without backlighting.

The "Glass Code" is an internal code used by LXD, which can be found on pages 2-15.

If required, Fast Response Extra Wide Viewing option is designated by an "F" immediately after glass code number.

The Modifications suffix letters are usually sequenced alphabetically at the end of the part number.

Refer to the illustration below for the explanation of the LXD part number breakdown.

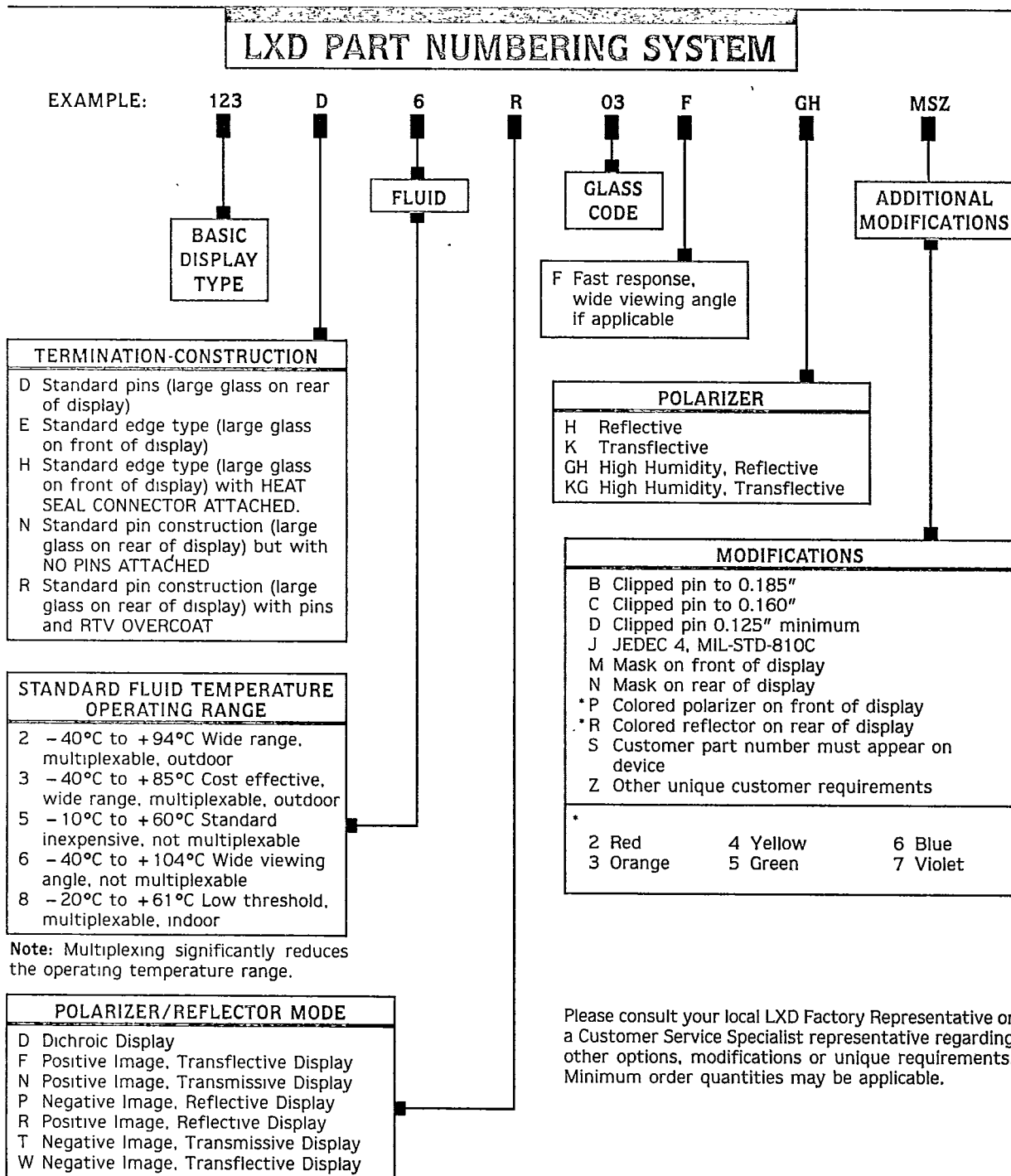

Please consult your local LXD Factory Representative or a Customer Service Specialist representative regarding other options, modifications or unique requirements. Minimum order quantities may be applicable.

VIEWING MODES

The first requirement of any display is that it must be readable when used in the intended application. Unlike other electronic display technologies (LED, PGD, VFD and ELD), which require additional power to emit light, LCD's are not light emitting. Twisted nematic, field-effect (TNFE) LCD's control ambient light. You can think of a TNFE LCD as an electronically controlled matrix of uniquely patterned shutter elements which can be normally open or normally closed. A more precise explanation of the TNFE LCD theory of operation is given on page 24.

We refer to a display having normally open elements as a positive image display, which has dark activated segments on a light background. Similarly, a display having normally closed elements is referred to as a negative image display, which has light character activated segments on a dark background. The orientation of the front and rear polarizer films on the LCD cell determines whether the display features a positive (crossed polarizers) or a negative (parallel polarizers) image viewing mode. The contrast ratio and transmission of an LCD is primarily determined by the polarizing efficiency and the percent transmission of the polarizer films. Cell spacing, drive voltage, and frequency, the wavelength of light, and temperature also affect the display transmission and contrast ratio.

For Outdoor applications requiring wide or high temperature range Liquid Crystal fluids, we also use high stability polarizers on our LCD's to assure reliable operation and safe storage in the harshest of environmental conditions. The front polarizer incorporates a UV filter and is usually laminated to the display with the axis of polarization in a vertical direction. This allows the display to be viewed with polarized sunglasses. For indoor applications where the environmental conditions are less extreme, we offer a wider range of commercial grade polarizers.

The optical switching action of TNFE LCD's can be observed in three selectable viewing modes: Reflective, Transflective or Transmissive. Each viewing mode is determined by the type of polarizer films laminated to the back of the display. Each viewing mode has its advantages and disadvantages as described below:

Transmissive

As the name implies, a display in this viewing mode does not incorporate a reflecting rear surface, and the display must be uniformly illuminated from the back. Transmissive LCD's are best suited for negative image contrast (light segments on a dark background). The user controls but must select and provide the method of backlighting, including color filters and background material. An optional diffusing front surface on the front polarizer scatters the emerging light and enhances the viewing angle.

Reflective

The rear polarizer includes a diffuse reflector, such as brushed aluminum. This reflects polarized ambient light back through the LCD cell. Reflective displays require ambient light. They exhibit high brightness, excellent contrast, and they provide wide viewing angles. They are particularly suitable for use in battery operated equipment where an adequate level of ambient light is always available. Because of its readability, simplicity and economy (no cost for auxiliary illumination) this is the most popular LCD viewing mode.

Reflective type LCD's can not be backlit. They can, however, be front lighted in some applications. Reflective displays are best suited for positive image contrast.

Transflective

The rear polarizer includes a translucent material which reflects part of the ambient light and transmits backlighting. As the name implies, it is a compromise between the transmissive and reflective viewing mode options. Used in reflection, it is not as bright and has lower contrast than the reflective type LCD, but can be backlit for use in low light conditions.

LXD offers two types of transflective surfaces. Where outdoor polarizers are specified, such as in marine electronics, a 6% transmission/high reflection, textured translector is standard.

For indoor applications, such as medical instruments, a 15% transmission/lower reflection, smooth translector is standard.

Transflective displays used in Marine Electronics and Medical Instrument applications are usually positive image LCD's. Transflective displays used in Military or Avionics applications are usually negative image. Automotive LCD's are usually negative image displays with multicolor transfectors.

As would be expected, various combinations of efficiency, transmission, hue, etc. are available to the LCD manufacturer from the various polarizer manufacturers. LXD tries to select the polarizer combination (front and back, reflector or translector) that gives the optimum balance of contrast, brightness and environmental stability. For outdoor displays, our focus is on environmental stability, whereas, for indoor displays, our focus is on cost and aesthetics. For negative image transmissive or transflective displays, we select a higher efficiency and lower transmission material to maximize the optical density of the display background. Our modern array manufacturing process assures uniformly thin cell spacing, which contributes to the superb viewing angle and contrast of our LCD's.

COLOR

There are a number of ways to provide color in LCD's. Since LCD's do not emit light, the color must come from polarizers, filters or auxiliary lighting.

LXD has approved blue, green and red colored transmissive front polarizers for use in indoor and outdoor applications. For instance, a reflective blue display exhibits medium blue segments on a bluish silver background.

It is possible for volume custom LCD applications to have a multi-color screened image polarizer as shown in the front cover photograph on our Design Guide for Custom LCD's.

Filters offer the greatest flexibility for colors in transfective displays. A yellow translector filter is,

for instance, popular for both positive and negative Very Large Area Displays (VLAD's) in message signs.

By changing the orientation of the rear polarizer, we can produce negative image or positive image color displays.

For backlit negative image displays, multicolor filters and transfectors can be applied to the back of the display. This can be achieved by screen printing fluorescent transfective inks on the rear transmissive polarizer or by application of a preprinted label or foil to the back of the display. Many vivid colors are currently available. LXD would recommend back-lighting under all lighting conditions. Because the seal is clear in the negative image display, LXD offers a perimeter mask to prevent unwanted light leakage.

VIEWING MODE SELECTION GUIDE

Designation	Viewing Mode	Description	Comments	Ambient Lighting Conditions			
				Direct Sunlight	Office Light	Subdued Light	Very Low Light
R	Reflective Positive Image	Dark segments on light aluminum background	Cannot be backlit. Aluminum provides best head-on contrast and environmental stability.	Excellent	Very Good	Poor	Unusable
F	Transfective Positive Image	Dark segments on grey textured 6% transmission or smooth 15% transmission background.	Lighted background is dimmer than "N" type and reflector is darker than "R" type. Can be viewed by reflected ambient light or with backlighting.	Excellent (No backlight)	Good (No backlight)	Good (Backlit)	Very Good (Backlit)
W	Transfective Negative Image	Light grey segments on a dark background.	Lighted segments are dimmer than "T" type. Needs high ambient light or backlighting. Popular viewing mode with color or multicolor translector.	Good (No backlight)	Fair (No backlight)	Good (Backlit)	Very Good (Backlit)
T	Transmissive Negative Image	Backlighting segments on a dark background	Lighted segments are brighter than "W" type. Cannot be read by reflection. Viewing angle enhanced with front diffuser.	Poor (Backlit)	Good (Backlit)	Very Good (Backlit)	Excellent (Backlit)
N	Transmissive Positive Image	Dark segments on a backlit background	Lighted background is brighter than "F" type. Less susceptible to washout by bright ambient light than "T" type. Less readable by reflection than "F" type.	Good (No backlight)	Good (Backlit)	Very Good (Backlit)	Excellent (Backlit)

ELASTOMERIC CONNECTORS (TYPICAL CONFIGURATIONS)

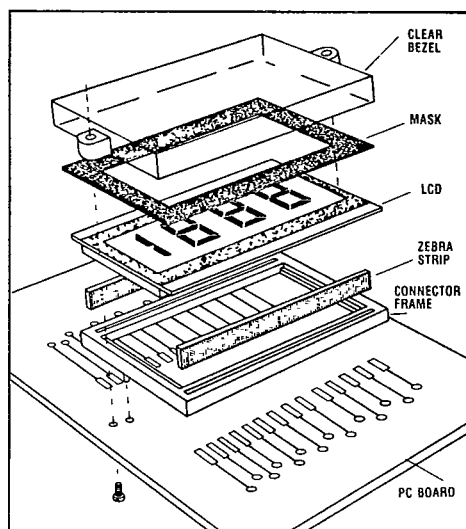

HEAT SEAL CONNECTOR

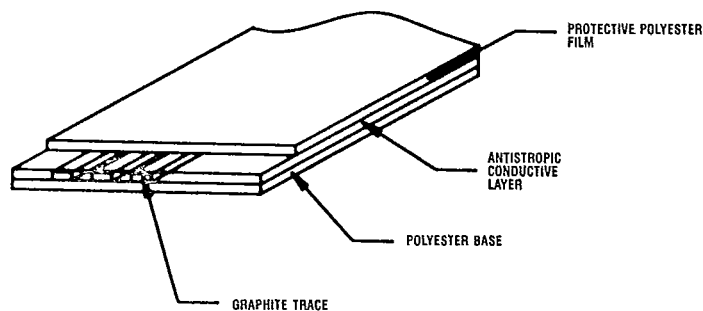

IN-LINE PINS

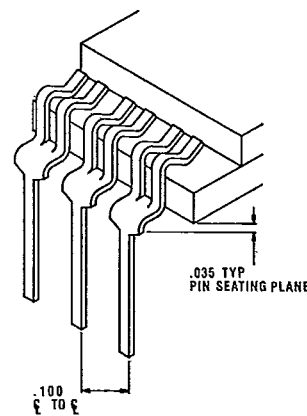
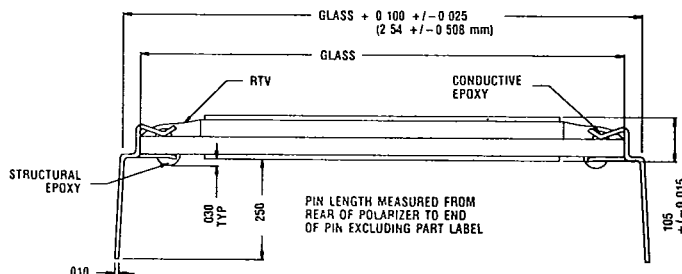

All of the LCD interconnect techniques illustrated above have been successfully employed in specific applications, and extensive use over many years has proven them to be reliable. Each interconnect method has its own unique features making it better suited for some applications than for others.

Dual-In-Line Pins:

This interconnect method offers the highest reliability of operation in the harshest of environmental conditions. Direct connection to the PCB is possible with soldering, or the LCD with DIL pins can be inserted into plug-in strip sockets. This system features: self alignment of the LCD, highly conductive corrosion free contacts, rigid mechanical support, rapid assembly and shock and vibration resistance. The pitch of the pins is physically limited to .100 inch (2.54mm).

Elastomer Connectors:

This low cost and easy to assemble interconnect method is the most popular for office products and consumer products. Dimensions of the contact pads are relatively flexible, and connector assemblies are available for some standard LCD glass sizes. Bezels are quite often tooled as part of the housing. This method of mounting is convenient for small instruments where space is at a premium. This system features: no soldering, rapid assembly/disassembly, space saving, self alignment, shock and vibration resistance and non-abrasive contact pads. Proper care must be

taken with this type of interconnect design to assure reliable operation of the display in environmentally demanding applications.

Snap-On Terminal Strips:

In this interconnect method, connection to the display is made via spring-pin connectors. The connectors connect the LCD to the PCB and hold it in position without additional accessories. The pin pitch is limited to .100 inch (2.54mm) and .050 inch (1.27mm), and the pins can be soldered on to a PCB or plugged into a strip socket connector. This method is usually lower cost than the DIL Pin method and offers many of the same features; however, it is less resistant to shock and vibration and will not perform as well in the most demanding environmental conditions. Some types will act as both electrical connector and mechanical holder of the LCD.

Heat Seal Connectors:

This interconnect method is often preferred for very large LCD's and where driver boards are to be mounted remote from the LCD. As the name implies, the connector is attached to the contact ledge of the display by the application of heat and pressure. Connection to a PCB is made directly in the same way, or by first connecting to a socket. Contact pad dimensions and pitch are flexible and the method offers a very reliable connection to the LCD. Tooling costs for the connector element may be substantial.

Direct Versus Multiplex Drive

This section provides general information on the two different drive schemes for LCD's that will allow the designer to make an initial determination of which to use for his or her application. For detailed information on Multiplexing including theoretical consideration and specific design solutions, please refer to LXD's application brochure titled, "Multiplexed Liquid Crystal Displays." This publication also includes suggested display drivers for the standard LXD display models and an extensive listing of LCD drivers for both Direct and Multiplex Drive LCD's.

Direct Drive Considerations

LCD's require an AC drive voltage with virtually no DC component. Prolonged DC operation may cause electrochemical reactions inside the displays which will cause significantly reduced life. Initial indications of display degradation due to DC are loss of alignment along the edges of some segments, which may progress to reduction of the indium tin oxide electrodes to indium tin, which is not transparent, and ultimately may lead to a chemical breakdown of the liquid crystal fluid and release of gas bubbles inside the display. LXD's barrier layer, however, greatly reduces the risk of this degradation process to take place.

Because an LCD is made up of several dielectric layers, this Equivalent Circuit (below) is a series of capacitors and a shunted resistor.

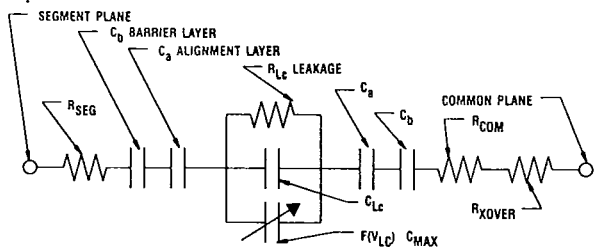

There are also series resistances to consider, including the resistivity of the indium oxide electrode paths and the crossover resistance. The TNFE LCD is an RMS Voltage responding device; that is, the turn on optical effect, or contrast of a segment, depends on the RMS value of the applied voltage. Direct drive offers the highest contrast over the widest temperature ranges and is normally a requirement for outdoor applications.

Drive frequencies for direct drive are typically between 30Hz and 60Hz. Depending on display size and

design, displays can be operated at higher frequencies, but this will result in increased power consumption. Operation below 30 Hz results in display flicker. (Refer to Liquid Crystal Direct Drive Technique box).

LCD's can be over driven by a combination of voltage and frequency which will result in cross talk or ghosting. Ghosting is the appearance or partial activation of an off-segment. This condition occurs when high drive voltage and frequency are simultaneously applied. Since current is proportional to frequency, there is a voltage-frequency product which must not be exceeded.

Multiplexing

As the number of display segments increases, direct drive may become impractical due to the number of drive circuits and external interconnects required. Both can be reduced by means of a technique known as time-multiplexing. When multiplexing a display, appropriate segments are connected together to form groups which are sequentially addressed by means of multiple rear electrodes. These groups are organized in a matrix of rows and columns. Typical multiplex drivers generate amplitude varying, time synchronized wave forms and apply them to the row and column lines of the multiplex display matrix at a fast rate, addressing the matrix location to be activated. To obtain optimum contrast of the "on" segments and to keep the "off" segments invisible, the operating voltage has to be chosen such that the "off" voltage is just below the threshold voltage. At low multiplexing rates, a wide operating temperature range is obtainable with constant voltage. At high multiplexing rates, the negative temperature coefficient of threshold voltage requires a temperature compensation of the voltage to achieve a constant viewing cone over the whole temperature range.

When designing multiplexed TNFE LCD systems, two important trade-offs must be considered:

- reduced operating temperature range
- reduced viewing cone

Both are interrelated and become more severe as the multiplex ratio is increased. The limit to which any given LCD can be multiplexed is determined more by the users environment and viewing requirements than by any controllable parameter in the display.

LIQUID CRYSTAL DIRECT DRIVE TECHNIQUE

Liquid crystal displays (LCD s) are driven using a symmetrical square wave with less than 50 mV D C offset. The low offset A.C drive is obtained in all LCD drivers by the use of CMOS exclusive OR (EX OR) outputs See fig 1.

Figure 2

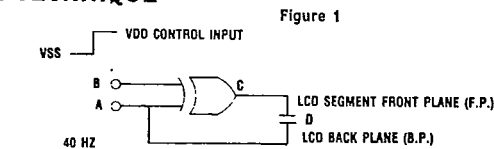
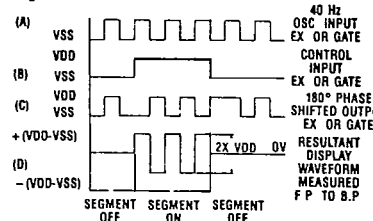

This configuration will result in a low D.C. offset A.C. drive with 2 x VDD peak value, or a RMS value equal to VDD for the LCD.

Figure 2 shows output waveforms of "exclusive OR" drives. Plot (A) is the 40 Hz 50% duty cycle square wave input to the "exclusive OR" gate. Plot (B) is the control waveform in which selects the mode of the display.

Plot (C) is the output of the "exclusive OR" gate in which has inverted the ocs input when the control input is high. Plot (D) is the resultant waveform of plot (A) and (C) as summed by the LCD. This waveform is measured with respect to the backplane of the display.

Comparison Between Direct and Multiplex Driving

Drive Method	Direct	Multiplex
Information Density	Low	High
Operating Temp. Range	Wide	Narrow
Viewing Angle	Wide	Narrow
Contrast Ratio	High	Low
Operating Voltage Range	Wide	Almost Fixed
Driving Wave Form	Simple	Complicated
Temp. Compensation Circuit	No	Yes
Number of Driver ICS	Many	Few
Number of Terminals	Many	Few
Reliability	Good	Good
Driver Cost	Highest	Lowest

Fundamental Philosophy of Quality Control

The twisted nematic, field effect, liquid crystal display (TNFE LCD) is a product technology that combines chemistry and electronics. Continuing miniaturization and the spread of electronics to more hostile environments has forced the LCD industry to set strict standards for quality and reliability.

LXD has developed a highly mechanized array process production facility, built around the best this technology has to offer. In this white glove world, quality is more than just a buzz-word, it is a state of mind that pervades the entire organization. This full circle of quality philosophy means that concern for product quality is first and foremost at LXD. Post mortems have no place in our array process methods. In making the transition from discrete element to array mass-production methods, it was necessary to change from an attitude of "don't ship mistakes" to "don't make mistakes". Every step we take in producing our product has its own quality checks, it's own standards to be met and someone responsible for that phase of the operation, who has the sense of purpose that this special field requires.

High volumes, low costs and unvarying quality are the true definitions of world-class manufacturing. LXD achieves these goals through the discipline of uniform manufacturing methods and statistical process control (SPC). A very important part of this discipline depends upon having highly automated custom equipment to implement our unique array process.

Every production process at LXD has been conceived and implemented with perfect uniformity in mind. Numerous, rigorous quality control check points ensure that every display leaving our facility is virtually indistinguishable from every other like display. We have also successfully minimized the variables of human operation through strictly enforced procedures and policies.

With this custom equipment, the array process, and controlled procedures in place, we are in a unique position of being able to expand our volume production, to further lower costs and improve quality as we extend our manufacturing capabilities to include Very Large Area Displays (VLAD's) of up to 13.5 x 13.5 inch size.

Full Circle of Quality with Statistical Process Control (SPC)

Concern for product quality is manifest at LXD. It starts with stringent vendor qualification of all manufacturing materials. Each batch of material is subjected to a vigorous incoming inspection including an environmental stress test before it is released to manufacturing. Our operators continuously monitor the process at each step, making sure that certain predetermined conditions and quality standards are met. In-process quality control check points, and finally a quality audit before shipment, assure that our standards for quality of the product leaving our factory are met at all times. Full raw material traceability is always maintained.

Each component of the multi-layered TNFE LCD

sandwich has its own test rationale:

Glass: Because it is the backbone of the display and interfaces with most other materials, glass is under particular scrutiny in the inspection program. Vendors have standards of quality to meet and these are validated at incoming inspection. Each lot is tested for dimensions, particularly thickness uniformity, resistivity, light transmission, durability, surface flaws and warp. In-process checks are made for coating adhesion and etchability.

Barrier Layer and Alignment Coating: The raw materials for these thin film layers are manufactured in-house. Each batch of material is subjected to laboratory analysis and evaluation as part of the routine process controls. Critical to eliminating shorted displays in the field is the use of our proprietary barrier layer, which insulates the electrodes from the liquid crystal fluid. This short barrier also performs as a passivation layer, preventing sodium ion migration out of soda lime glass, which can cause loss of fluid alignment and create a permanently dark background in a positive image LCD, reducing contrast. Our proprietary humidity resistant alignment coating further contributes to the stability of the fluid alignment.

The barrier layer further produces two extra benefits: (1) A more uniform glass surface, free of contamination, that contributes to alignment stability, and (2) Matched indices of refraction of the different thin film layers inside the device minimizing undesirable internal reflections.

Liquid Crystals: The physical, chemical, and electro-optical properties of each batch are checked and qualified before these materials are issued to manufacturing. Coincident with the development of the array process, more stable liquid crystals, less susceptible to contamination were introduced to the process.

Seal Materials: Like the barrier layer and alignment coating materials, each batch of these proprietary, in-house manufactured materials are subjected to laboratory analysis and qualification before it is issued to manufacturing. The seal materials must provide adhesion that will withstand the rigors of assembly, fabrication and installation into the equipment on which the display is used, as well as any temperature and humidity extremes encountered on earth. The seal materials must further be compatible with the fluids and glass used, and the barrier layer, as it makes physical contact with all of them.

In developing the specially formulated seal materials now being used, tests were devised and repeated hundreds of times to prove these materials superior resistance to mechanical and environmental stress.

Polarizers: Polarizers are visually inspected for flaws. Environmental stability tests at +85°C, 95% R.H., with daily cycle to -40°C, are then conducted for four days minimum, before the materials are released to production.

Bonding of the polarizer films to the glass is a critical operation that must be carefully adapted to high-volume production. Cleanliness of the glass onto which the polarizer film is laminated is under stringent

control. To achieve the best possible adhesion between glass and polarizers the displays are autoclaved. With our customized bonding equipment, cleanliness control and autoclaving, we have eliminated all field delamination problems in high temperature and humidity applications.

Substrate Clips: Our DIL pins are measured for gauge, pin and row spacing and cut length. They are selectively tested for insertion force and contact force, and they are pull tested to verify epoxy strength. A thin coating of solder is applied to the pin phosphor bronze base metal, to assure that the products meet the most stringent solderability requirements. The DIL pins are trimmed to $\pm .010$ inch in length, and checked for a registration tolerance of $\pm .005$ inch.

Outdoor displays also feature an optional RTV-silicone coating which encapsulates the indium oxide contact pads and completely seals the crevice between the two pieces of glass. This prevents contact pad corrosion in even the harshest of high humidity environmental conditions, and eliminates this potential cause of open segments.

Superior Quality & Reliability

After each production lot has been 100% inspected for visual and electrical defects, it is delivered to a final QA audit which inspects to a 0.25% AQL for critical and major defects, 0.5% for minor defects and 1.5% for control defects. Each lot must meet mechanical, visual, electrical, coding and packaging criteria before being released to shipping.

In addition, reliability stress testing is done on samples from each manufacturing lot each day. Two unpolarized displays are subjected to an over stress of $+125^{\circ}\text{C}$ for a minimum of 35 days to look for signs of alignment stability problems or seal weaknesses. Two displays from each manufacturing lot are burned in at $+80^{\circ}$ for 1000 hours, to determine if there are memory or electrical problems. Another two displays are environmentally stressed at $+85^{\circ}\text{C}$, 95% R.H., with a 2-hour thermal cycle each day to -40°C , to verify stability of all materials and processes. Additionally, sample testing of displays without polarizer is performed for up to 100 hours at $+121^{\circ}\text{C}$, 15 PSI super heated steam pressure, to look for other potential weaknesses of the devices, particularly related to seal performance.

Before shipment, each display and carton of displays is labeled with a lot number that is entered into a computer along with customer identification numbers and dates of manufacture. This becomes part of a complete data base that provides traceability down to each major material, each process and each vendor's identification, in case a problem should occur in the field.

Long Life LCD's

Long life liquid crystal displays are offered by LXD for those applications in which service life and reliable performance out weigh all other considerations.

With appropriate fluids and polarizer options, the long-life LCD's operate over a temperature range of -40°C to $+104^{\circ}\text{C}$, and are recommended for outdoor applications where extremes of temperature and relative humidity are encountered. All LXD's LCD's are produced in a process particularly designed to eliminate two major types of failures; (1) Functional failures, and (2) Early end of life failures. Functional field failures include seal leaks, shorts, open segments, and ghosting. Our reliability data show that these developmental defects are less than .0005% per year. Early end of life failures, including loss of alignment, bloating and high current, have been eliminated through the use of our improved materials and array process. Displays made under these conditions have endured accelerated life tests at high humidity and high temperatures. An operating life of 20 years or more can be projected. Today, testing is for millions of device hours instead of a few thousand.

In evaluating the performance of TNFE LCD's there are three yardsticks:

- Quality, which is the requirement of the LCD user that mechanical dimensions and tolerances, operational characteristics, aesthetics, workmanship, packaging delivery, and all other valued specifications are being met;
- Reliability, which indicates the acceptable failure rate of the device in the field;
- Lifetime, which indicates how long the product will last in the application.

Although JEDEC standards govern, our target for product performance is to continue to set new records for life and reliability.

Twisted Nematic Field Effect LCD Technology

The range of the liquid crystal state of matter is defined by two transition temperatures. At the upper end of the temperature range the LC material changes phase, becoming an isotropic liquid. This is the nematic to isotropic transition temperature. At the lower temperature, or melting point, the LC material approaches a solid or crystalline state. This is the crystalline to nematic transition temperature. Between the two transition temperatures, the LC material possesses some properties of both liquids and crystals.

The nematic to isotropic transition temperature determines the upper operating temperature limit. The crystalline to nematic transition, which defines the theoretical melting point, does not necessarily determine the lower operating temperature limit. As the temperature decreases below the crystalline to nematic transition temperature, this transition does not occur because most LC materials supercool. In a wide temperature range LCD, having a lower temperature limit of -40°C , prolonged exposure to temperatures well below -60°C may be required before the thin film of LC material becomes frozen in the crystalline state. This allows LCD's to operate satisfactorily well below the crystalline to nematic transition temperature. Here the response time becomes the limiting factor, as it is a function of the viscosity of the LC material, which increases as the temperature decreases. This restraint on the mobility of the LC molecules at lower temperatures, in combination with cell spacing and drive voltage, determines the lower limit of the operating temperature range for practical applications.

The nematic LC molecules in a TNFE LCD form a helix when looking into the display from front to back. The rod-like molecules at the front of the cell may be vertically oriented and those at the back of the cell horizontally oriented. Those in the center are somewhere in between, forming a very orderly 90° helix.

The key to the operation of a TNFE LCD is that this twisted nematic liquid crystal structure has the ability to rotate the plane of polarized light as it passes through the molecular layers. When randomly polarized, light is polarized in the vertical plane and passes through the liquid crystal helix described above, the light is twisted following the helical arrangement of

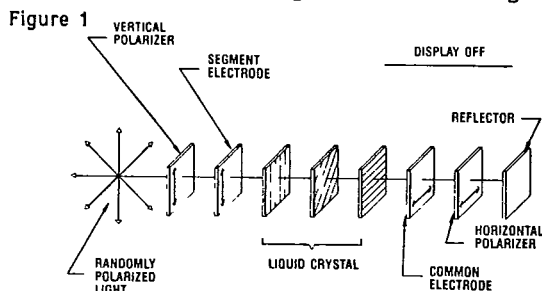
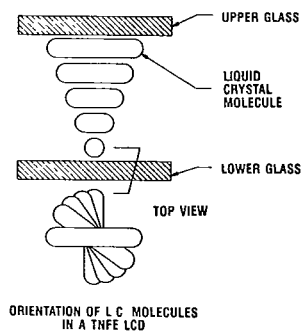

Figure 1

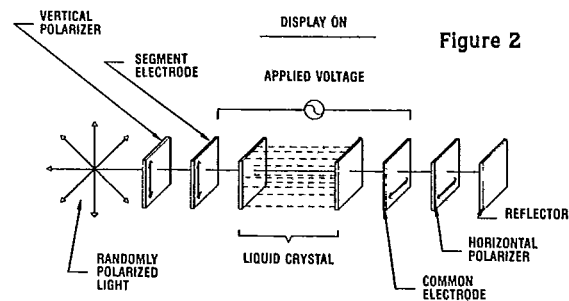

Figure 2

the molecules. Light leaving the back of the display will be polarized in the horizontal direction.

If a reflector is placed behind the display, as shown in Figure 1, the polarized light will return along its entry path, being twisted as it again passes through the helix. If the helix of molecules is placed in an electric field (Figure 2), the molecules in the center of the cell will align with the electric field destroying the helix. The polarized light entering the front of the liquid crystal cell will not be twisted, but will emerge from the rear of the cell polarized in the vertical plane. When this vertically polarized light encounters the horizontally oriented rear polarizer, it will be extinguished and the display would appear dark. Importantly, however, when the field is turned off, the twist structure is perfectly restored. In a reflective display, this area of extinction would be precisely defined by the overlapping common and segment plane electrode pattern, resulting in a dark area on a light reflective background. This viewing mode is commonly referred to as a positive image display. By using parallel rather than crossed polarizers, an inverse image is obtained, where activated areas or segments appear light on a dark background. This viewing mode is commonly referred to as a negative image display.

TNFE LCD Construction

The construction of the TNFE LCD is an implementation of the above operating principles. A very thin layer, typically less than 8 microns, of LC material is encapsulated in a flat glass sandwich. The inside surfaces of the glass cell are coated with a transmissive conductive coating, usually indium-tin oxide, and chemically milled, using standard photo lithographic techniques, to form the common and segment electrode patterns.

In LXD's unique array process, both the segment plane and common plane electrodes are covered with a thin barrier or passivation layer, which benefits are described in the Quality, Reliability and Long Life section of this catalog. Each electrode surface is then coated with a thin alignment layer, which is then striated to give the adjacent LC molecules an alignment in a preferred direction to effect the 90° twisted LC structure in the cell. Precise control of cell thickness is achieved using spacers between the two glass plates. Because the cell spacing is 8 microns or less, the problem is not trivial. Failure to get a thin, uniform cell spacing will result in a display with poor electro-optical performance. A conductive crossover path is used to connect the common electrode and the common contact pad on the segment plane glass. This eliminates the awkward operation of having to make

contact to two different glass surfaces. A seal holds the glass substrates together and forms a cavity for the LC fluid. After vacuum filling the cell with LC fluid and plugging the fill hole(s), the liquid crystal cell is complete. To finish the LCD, polarizer films must finally be carefully laminated to the assembled cell.

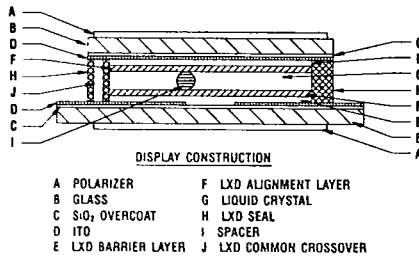

The front polarizer is usually attached with the axis of polarization in a vertical direction, to allow the display to be viewed by an observer wearing polarized sunglasses.

TNFE LCD User Considerations

Liquid Crystal displays do not generate light, but absorb light passing through them and as such are categorized as passive displays. By taking advantage of the TNFE LCD's unique capability to pass or block light with only microwatts of power per display, the display user has at his command an electronically controlled shutter, or an array of uniquely sized and shaped shutters in a single cell. These shutters can be normally open or normally closed depending upon the orientation of the rear polarizer. The contrast of a TNFE LCD depends upon the polarizing efficiency and transmission of the polarizing films employed as well as the cell spacing and the LC material. For any given LC material, there are precisely defined first or second minima cell spacings that will maximize the contrast ratio. First minima devices provide the added benefits of fast response and wide viewing angles.

The TNFE LCD is truly unique in combining principles of light, electronics, and chemistry, to produce a display technique characterized by low power usage, high reliability, clarity of image, and almost unlimited custom design capability for the image to be displayed.

LCD TECHNOLOGY TRENDS

LXD has a history of being an innovator in the TNFE LCD technology. These milestones of innovation tell a story of our commitment to the LCD technology and market development, that resulted in LXD being recognized as the world leader in the development and production of unsurpassed quality High Reliability, Long Life LCD's and Very Large Area Displays (VLAD's) for use in the most demanding of outdoor applications.

One of the early milestones of innovation occurred in 1975 when LXD first patented the DIL pin large area LCD. LXD was first with integral EL Backlighting for large area LCD's, and also first with wide temperature range LX fluids for use in high temperature and humidity outdoor LCD applications, such as gas pumps and marine electronics. We were even first with bar graph and dot matrix and other types of multiplexed LCD's. A combination of vision, skill, expertise and a market driven, pioneering development team made LXD the early leader in TNFE LCD technology development and application.

In the early 1980's, LXD continued to be an LCD

technology leader, developing improved performance LCD's that set new standards for extended temperature ranges, greater environmental stability, exceptional speed of response, and the "sharpest viewability", meaning higher contrast at wider viewing angles for improved readability. LXD was also first in developing multicolor negative image displays and introduced them to the automotive industry.

The High Reliability, Long-Life LCD featuring a unique multipurpose barrier layer and the LCD world's first 14" x 14" Array Manufacturing Process, are relatively recent innovations that opened up new outdoor markets for 20 year life LCD's. The most recent successful development is a new generation of Fast Response/Wide Viewing Angle, Very Large Area Displays (VLAD's.) These new first minima TNFE LCD's are now finding acceptance in outdoor variable message signs for alphanumeric messages and simple graphics. One full laminate size model is even used in full color, outdoor videoboards.

CUSTOM LIQUID CRYSTAL DISPLAYS

In addition to our high reliability long life display, LXD offers complete design and prototype services to designers of custom liquid crystal systems. An inherent advantage of LCD technology is its flexibility in format and size. It is well suited to LXD's array process for medium to high volume production. Custom displays are subject to a one time, non-recurring engineering charge determined by the complexity of the display, plus a charge for the fabrication of prototypes.

To obtain a quotation for a custom LCD, please submit the following information to your LXD sales representative or to our application engineering department:

- (1) A sketch or drawing of the information to be displayed with critical dimensions noted. Tell us the maximum glass size, minimum viewing area (bezel opening) location, and size of image area elements. Please let us determine the pinout.
- (2) Expected operating and storage environment. Is it an indoor or an outdoor application?
- (3) Viewing mode (reflective, transfective, etc.)

- (4) Desired connection method (DIL pins, elastomers, etc.)
- (5) If applicable, specify multiplex format, preferred drivers, voltage, and optimum viewing angle.
- (6) Projected timing and quantities of prototypes and production displays.

Typical leadtimes on custom LCD development programs are:

- (1) Cost and engineering analysis: less than 2 weeks.
- (2) Specification drawing: 1-2 weeks ARO.
- (3) Prototypes: 6-8 weeks after specification drawing approval.
- (4) Production quantities: 6-10 weeks after prototype approval.

Please contact the LXD Factory Representative in your area or an LXD Customer Service Specialist for information on the availability of shorter lead-times. You may also wish to request our "Design Guide" for Customized Liquid Crystal Displays.

