

CMI-8738/PCI-SX C3DX PCI-Based HRTF 3D Extension Positional Audio Chip

Features

- ◆ **HRTF-based 3D positional audio, supporting DirectSound™ 3D and A3D™ interface**
- ◆ **Supports rear side speakers, C3DX positional audio in 4 CH speaker mode**
- ◆ **Legacy audio SBPro™ compatible**
- ◆ **DLS-based wavetable music synthesizer, supports DirectMusic™**
- ◆ **Built-in 32ohm Earphone buffer**
- ◆ **Drivers support EAX™, Karaoke Echo, Key Surround sound**
- ◆ **MPU-401 port**
- ◆ **Dual game port**
- ◆ **16-bit full duplex CODEC**
- ◆ **4 CH 16-bit DAC**
- ◆ **32-bit PCI bus master**
- ◆ **External E²PROM interface**
- ◆ **Single chip design, +5V, 128 pins QFP**

With high speed PCI V2.1 bus controller and legacy audio SB16® DSP emulator, CMI8738 is designed for PC add-in cards and all-in-one motherboards. No external CODEC is needed in CMI8738: CMI-8738 supports the legacy audio – SB16™, FM emulator/DLS wavetable music synthesis, and HRTF 3D positional audio functions.

Being compatible with A3D™ and DirectSound™ 3D, CMI8738 meets PC99® requirements

CMI8738 uses HRTF 3D extension technology to enhance traditional HRTF 3D positional audio by **substituting two-speaker system by four-speaker one** (it supports additional 2CH 16-bit DAC to provide rear side audio). It greatly improves HRTF 3D positional audio quality and successfully removes the sweet spot limitations: users can enjoy genuine 3D audio gaming effects, and don't have to worry about the environmental confinement any more.

Being outstanding for its full audio functions, competitive price, and power management, CMI-8738 is the best choice for people seeking for optimum use of the PC applications.

C-Media licensed HRTF 3D library from [Central Research Lab \(CRL®\), U.K.](#), who provides one of the world's best HRTF libraries

CMI-8738/PCI Block Diagram

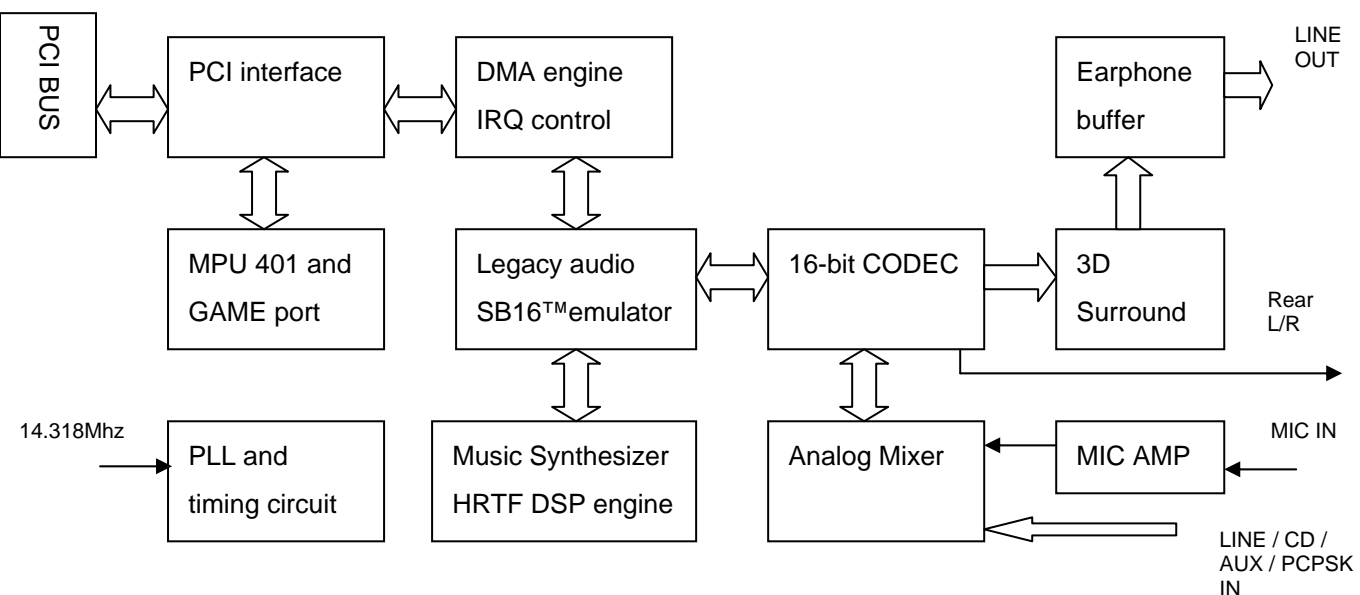

DIGITAL PIN DESCRIPTION

Name	Number	PIN Type	Definition
XA31-XA0	126-128,1-2,5-7,12-16,19-21,32-35,38-41,43-44,47-52	I/O	PCI bus address and data lines
XINTA	117	O	Interrupt request , active-low.
XPRST	119	I	Reset
XCLK33	120	I	PCI bus clock.
XGNT	121	I	Bus master grant, active-low.
XREQ	122	O	Bus master request, tri-state output, active-low.
XIDSEL	9	I	ID select, active-high.
XFRAME	23	I/O	Cycle frame, active-low.
XIRDY	24	I/O	Initiator ready, active-low. The bus master device is ready to transmit or receive data
XTRDY	25	I/O	Target ready, active-low. The target device is ready to transmit or receive data
XDEVSEL	26	I/O	Device select, active-low. The target device has decoded the address of the current transaction as its own chip select range.
XSTOP	29	I/O	Stop transaction, active-low. The target device request to the master to stop the current transaction.
XPAR	30	I/O	Parity. The pin indicates even parity across XA31-XA9 and XCBE3-0 for both address and data phases.
XCBE3,2,1,0	8,22,31,42	I/O	Multiplexed command/byte enable. These pins indicate cycle type during the address phase of a transaction.
VDD	4,10,18,27,37,45,54,115,124	+5V	Digital and PCI I/O power pin
GND	3,11,17,28,36,46,53,114,116,125	GND	Digital and PCI I/O ground
XIN	55	I	14.318Mhz crystal, or external clock input
XOUT	56	O	14.318Mhz crystal
XGD7-XGD4	97-94	I	Game port switch input pin. Switch D to switch A
XGD3-XGD0	93-90	I/O	Game port resistor input pin. RC3 to RC0
XTXD	88	O	MIDI transmit data
XRXD	89	I	MIDI receive data
XBIO3-XBIO0	109-112	I/O	General purpose I/O
VDD5V	83	+5V	Digital and PCI I/O power pin
VDDM	100	+5V	Digital and PCI I/O power pin
DGND	99	GND	Digital and PCI I/O ground
XEECS	84	O	EEPROM chip select

ANALOG PIN DESCRIPTION

AVDD	61,81	+5V	Analog power
AGND	60,82	GND	Analog ground
XADOUTL-R	64,65	AO1	Line out
XADCHL-R	66,67	AI/O	ADC filter
XLFILF	68	AI/O	Left channel DAC filter
XRFILF	69	AI/O	Right channel DAC filter
XVREF	63	AI	Reference Voltage (no use, left it floating)
XINTVREF	62	AI	Reference Voltage
XCDL-R XCDGND	71,72,70	AI	CD audio differential input
XLNL-R	75,76	AI	Line in or Rear speaker out
XAUXL-R	77,78	AI	Aux. Line in
XPCSPKIN	79	AI	PC beep signal
XMICIN	80	AI	Microphone in
XREARL-R	73,74	AI/O	Rear speaker out
XGPBIO	87	O	General purpose I/O pin
XMBCSZ	85	I	Audio chip select (low:enable)
NC	57-59,86,98,101-108,113,118,123	-	Reserved

ELECTRICAL CHARACTERISTICS

Absolute Maximum Ratings

Ratings	Symbol	Value	Units
Digital power voltage	VDD	VDD±5%	V
Analog power voltage	AVDD	AVDD±5%	V
Operating temperature range	TO	0 to 70	°C
Storage temperature range	TST	-40 to 125	°C
Maximum power dissipation	PDMAX	300	MW

Digital Characteristics

PARAMETER	Symbol	Min	Typ	Max	Unit
Input high voltage(PCI I/O)	VIH	2.		VDD+0.5	V
Input low voltage (PCI I/O)	VIL	-0.5		0.8	V
Output high voltage	VOH	2.4		VDD	V
Output low voltage	VOL	0.0	0.2	0.4	V
Output buffer current			5		mA

Audio Characteristics

PARAMETER	Symbol	Min	Typ	Max	Unit
Analog input voltage	Avin		1.1		VRms
Analog output voltage	Avout		1.1		VRms
A-A S/N ratio			85		db
A-A THD			0.09		
ADC S/N ratio			80		db
ADC THD			0.1	0.2	%
DAC S/N ratio			80		db
DAC THD			0.1	0.2	%
Microphone input level		20		200	mv
Microphone booster				20	db

CMI8738 PCI Configuration Spaces

- 00h** 13F6 : (**Vender ID**) read only
- 02h** 0111 : (Device ID) read only
- 04h** 0006 : Command (State after #RST all is "0")
- 0 (bit 9) Fast back-to-back enable
 - 0 (bit 8) #SERR enable (R/W)
 - 0 (bit 7) Wait cycle control
 - 0 (bit 6) Parity error response
 - 0 (bit 5) VGA palette snoop
 - 0 (bit 4) Memory write and invalidate enable
 - 0 (bit 3) Special cycles
 - 1 (bit 2) Bus master (**R/W**)
 - 0 (bit 1) **Memory space**
 - 1 (bit 0) I/O space (**R/W**)
- 06h** 0280 : Status
- 0 (bit 15) Detected Parity Error
 - 0 (bit 14) Signaled System Error
 - 0 (bit 13) Received Master Abort
 - 0 (bit 12) Received Target Abort
 - 0 (bit 11) Signaled Target Abort
 - 01 (bits 10-9) **DEVSEL timing** 00-fast, 01-medium, 10-slow
 - 0 (bit 8) Data Parity Error Detected
 - 1 (bit 7) **Fast Back-to-Back Capable**
 - 0 (bit 6) UDF Supported
 - 0 (bit 5) 0-33MHz ,1-66MHZ Capable
 - 00000 (bits 4-0) Reserved
- 08h** 10 : Revision ID
- 09h** 040100 : Audio device
- 0Ch** 00 : Cache Line Size
- 0Dh** 20 : **Latency Timer**
- 0Eh** 80 : Header Type
- 0Fh** 00 : BIST

- 10h 0000d401 : I/O of length : -65280(ffff0100h) : First Base Address register
- 14h 00000000 : Uninitialized : Second Base Address register
- 18h 00000000 : Uninitialized : Third Base Address register
- 1Ch 00000000 : Uninitialized : Fourth Base Address register
- 20h 00000000 : Uninitialized : Fifth Base Address register
- 24h 00000000 : Uninitialized : Sixth Base Address register
- 28h 00000000 : Cardbus CIS Pointer
- 2Ch 13f6 : **(SubSystem Vender ID)** (R/W)
- 2Eh ffff : **SubSystem ID** (R/W)
- 30h 00000000 : Expansion ROM Base Address
- 34h 00000000 : Reserved
- 38h 00000000 : Reserved
- 3Ch 05 : **Interrupt Line**
- 3Dh 01 : **Interrupt Pin**
- 3Eh 02 : **Min Grant**
- 3Fh 18 : **Max Latency**

DMA Slave Configuration Register(R/W)

PCI Configuration address 40H

Bit(s)	Function
31:16	Reserved
15:4	Slave Base Address 15-4. INTEL VX chipset seleted if Base Address 15:4=000h
3	Non legacy Extended Addressing 0 = disabled 1 = enabled
2:1	Transfer Size 00 = 8 bit transfer 01 = 16 bit transfer 10 = 32 bit transfer, non legacy 11 = Reserved
0	Channel Enable 0 = disabled 1 = enabled

Internal Register Mapping

Function Control Register 0

 Address **00H**

Bit(s)	R/W	Name	Description
31-20		Reserved.	
19		RST_CH1	Channel1, 1->Reset (Default 0)
18		RST_CH0	Channel0, 1->Reset (Default 0)
17		CHEN1	Channel1, 1->Enabled, 0->Disabled.
16		CHEN0	Channel0, 1->Enabled, 0->Disabled.
15-4		Reserved	
3		PAUSE1	Channel1, 1->Pause if channel1 is enabled.
2		PAUSE0	Channel0, 1->Pause if channel0 is enabled.
1		CHADC1	Channel 1, 1->Recording, 0->Playback
0		CHADC0	Channel 0, 1->Recording, 0->Playback

Function Control Register 1

 Address **04H**

Bit(s)	R/W	Name	Description
31-16		Reserved	
15-13		DSFC[2:0]	DAC Sampling Frequency Select,
		0 0 0	5.512 K
		0 0 1	11.025 K
		0 1 0	22.05 K
		0 1 1	44.1 K
		1 0 0	8 K
		1 0 1	16 K
		1 1 0	32 K
		1 1 1	48 K
12-10		ASFC[2:0]	ADC Sampling Frequency Select,
		0 0 0	5.512 K
		0 0 1	11.025 K
		0 1 0	22.05 K
		0 1 1	44.1 K
		1 0 0	8 K

	1	0	1	16 K
	1	1	0	32 K
	1	1	1	48 K
9-6	Reserved			
5	INTRM		Interrupt Mask bit for MCB (Master control block) module interrupt. 0 MCB interrupt disabled. 1 MCB interrupt enabled.	
4	BREQ		If this bit is set low it will prevent the MCB and DAC/ADC block from accessing the memory. 0 Bus Master request disabled(power on state) 1 Bus Master request enabled.	
3	VOICE_EN		This bit enables Legacy Voice device(SB16,FM). 0 Legacy Voice disabled on channel 0. 1 Legacy Voice enabled on channel 0.	
2	UART_EN		This bit enables Legacy UART device. 0 UART disabled 1 UART enabled	
1	JYSTK_EN		This bit enables Legacy Joystick device. 0 Joystick disabled 1 Joystick enabled	
0	Reserved			

Channel Format Register

 Address **08H**

Bit(s)	R/W	Name	Description
31-24		VER[7:0]	PCI Audio subversion for internal identification. "01"
23-19		Reserved	
18		FMOFFSET2	When set 1 and Reg. 24H bit7 'FMmute=1', FM PCM will be forced to DC value 0002H.
17-16		Reserved	
15-14		AdcBitLen[1:0]	Sample resolution 00 16 Bits per sample . (Default) 01 15 Bits per sample. 10 14 Bits per sample. 11 13 Bits per sample.
13-12		AdcDacLen[1:0]	Sample resolution 00 600nSec per bit in a sample. 01 660nSec per bit in a sample.

	10	1.3uSec per bit in a sample. (Default)
	11	2.8uSec per bit in a sample.
11		CH1 Ssmple Rate 176K
10		CH1 Sample Rate 88K
9		CH0 Sample Rate 176K
8		CH0 Sample Rate 88K
7-4		reserved
3-2		CH1FMT[1:0] Data format of channel 1
	00	8 bit Mono mode
	01	8 bit Stereo mode
	10	16 bitMono mode
	11	16 bitStereo mode
1-0		CH0FMT[1:0] Data format of channel0
	00	8 bit Mono mode
	01	8 bit Stereo mode
	10	16bit Mono mode
	11	16 bitStereo mode

Interrupt Hold/Clear Register

 Address **0CH**

Bit(s)	R/W	Name	Description
31-19		Reserved	
18		TDMA_INT_EN	Interrupt hold/clear bits for updating TDMA position
		0	Interruupt Clear
		1	Interrupt Hold if exist.
17		CH1_INT_EN	Interrupt hold/clear bits for the Channel 1.
		0	Interrupt Clear
		1	Interrupt Hold if exist.
16		CH0_INT_EN	Interrupt hold/clear bits for the Channel 0.
		0	Interrupt Clear
		1	Interrupt Hold if exist.
15-0		Reserved	

Interrupt Register

 Address **10H**

Bit(s)	R/W	Name	Description
31	R	INTR	Interrupt reflected from any sources.
		0	No interrupt

			1	Interrupt pending
30-28		Reserved		
27	R	VCO		
26	R	MCBint		Abort conditions occur during PCI Bus Target/Master Access.
			0	No interrupt
			0	Interrupt pending
25-17		Reserved		
16	R	UARTint		This bit is the UART interrupt bit.
			0	No UART interrupt
			1	UART interrupt pending
15	R	LTDMAINT		Interrupt for updating Low Channel TDMA position.
			0	No interrupt
			1	Interrupt pending
14	R	HTDMAINT		Interrupt for updation High Channel TDMA position.
			0	No interrupt.
			1	Interrupt pending.
13-8		Reserved		
7	R	XDO46		Direct programming EEPROM interface , read data register
6	R	LHBTOG		High/Low status from DMA CTRL register.
5	R	LegHDMA		Legacy is in High DMA channel.
4	R	LegStereo		Legacy is in Stereo mode.
3	R	Ch1Busy		Channel B Busy.
2	R	Ch0Busy		Channel A Busy.
1	R	Chint1		Channel B Interrupt.
			0	No interrupt
			1	Interrupt pending
0	R	Chint0		Channel A Interrupt.
			0	No interrupt
			1	Interrupt pending

Legacy Control/Status Register

 Address **14H**

Bit(s)	R/W	Name	Description
31		Reserved	
30-29		VMPU [1:0]	Base address for MPU401 access
			00 Base address : 330h
			01 Base address : 320h
			10 Base address : 310h

		11	Base address : 300h
28			Reserved
27-26	VSBSEL[1:0]		The Base Address Select for SB16 access.
		00	Base address: 220h
		01	Base address: 240h
		10	Base address: 260h
		11	Base address: 280h
25-24	FMSEL[1:0]		The Base Address Select for FM access.
		00	Base address : 388h
		01	Base address : 3C8h
		10	Base address : 3E0h
		11	Base address : 3E8h
23-21			Reserved
20	SetRetry		Mode of wait state . 0:legacy I/O wait (default) 1:legacy I/O BUS
			retry
19	C_EEACCESS		Direct programming EEPROM interface Registers.
18	C_EECS		
17	C_EEDI46		
16	C_EECK46		
15-0			Reserved

Micellaneous Control Register

Address 18H

Bit(s)	R/W	Name	Description
31		PWD	Power Down Mode enabled..
30		RESET	Reset Bus Master/DSP Engine.
29-28		SFIL[1:0]	Four level of filter control at the front end DAC..
27		TX/VX	Which motherboard to work with
		0	VX chip sets.
		1	TX chip sets.
26		N4SPK3D	Hardware copy front channel to rear channel
25-24			Reserved
23		ENDBDAC	Default low, High will enable Double DAC structure.
22		XCHGDAC	Default low,
		0	CH0 > Front SPKR, CH1 > Back SPKR.
		1	CH0 > Back SPKR, CH1 > Front SPKR.
21-20			Reserved
19		FM_EN	Legacy FM enabled.

18-17	Reserved	
16	VIDWPDSB	Sub ID write protect disabled. (default 0)
15	Reserved	
14	MASK_EN	Activate channel mask on Legacy DMA.
		0 Disabled
		1 Enabled
13	VIDWPDSB	Write Protect of HSP Configuration Sub ID.
		0 Protect.
		1 No protect.
12	SFILENB	Let software contrl filter stepping at the front end DAC.
11-5	Reserved	
4	MIDSMP	Enable 1/2 interpolation at the Front end DAC..
3-2	UPDDMA[1:0]	For every the number of samples to notify updating TDMA position.
		00 Every 2048 samples
		01 Every 1024 samples
		10 Every 512 samples.
		11 Every 256 samples.
1-0	TWAIT[1:0]	For controlling the length of legacy BUS cycle.
		00 3 PCICLK.
		01 18 PCICLK.
		10 24 PCICLK
		11 32 PCICLK
* Notice	REQ_SQ[2:0]	States of BusRequest Engine.
	MM_DATA	Bus Master is using Bus.
	MIDLE	Bus Master is not using Bus.
	REQA/REQB	Channel 0/1 BusMaster Request.
	GNTA/GNTB	Channel 0/1 BusMaster Grant.
	ADRQ/BDRQ	Channel 0/1 DMA Request.
	ADACK/BDACK	Channel 0/1 DMA Acknowledge.
	AIRQ/BIRQ	Channel 0/1 Interrupt.
	CX/BX	Channel 0/1 Busy.

T - DMA Position

Address **1CH**

Bit(s)	R/W	Name	Description
31-16	R	TDMACN T	Current Byte/Word Count of DMA channel.
15-0	R	TDMAADR	Current Address of DMA channel.

Mixer Control / Device Configure Register (can be accessed only by **BYTE** instruction)

Address **20H**

Bit(s)	R/W	Name	Description
7-0	W	SBVR[7:0]	Programmable SB16 version No.
	R	DEV[7:0]	Hardwire device version No.

Address **21H**

Bit(s)	R/W	Name	Description
7-3		Reserved	
2		X_ADPCM	SB16 ADPCM enable,default disabled.
1		PROINV	SBPro Left/Right channel switching.
0		X_SB16	Indicate device active as SB16 compatible, default SB16

Address **22H**

Bit(s)	R/W	Name	Description
7-0		IDXdata	Mapping SB compatible mixer INDEX register data port(A2x5h)

Address **23H**

Bit(s)	R/W	Name	Description
7-0		IDXaddr	Mapping SB compatible mixer INDEX register address port(A2x4h)

Address **24H**

Bit(s)	R/W	Name	Description
7		Fmmute	Mute FM
6		Wsmute	Mute Wave stream
5		SPK4	select four speaker mode(emulate Line in to Line out)
4		Rear2front	exchange rear and front channels's speaker out
3		Waveinl	Digital Wave recording Left channel
2		Waveinr	Digital Wave recording Right channel
1-0		Reserved	

Address **25H**

Bit(s)	R/W	Name	Description
7		RAUXREN	Recording source select R-Aux
6		RAUXLEN	Recording source select L_Aux
5		VAUXRM	R-AUX mute control
4		VAUXLM	L-AUX mute control



3-1	VADMIC[2:0]	Recording MIC volume control
0	MICGAINZ	MIC gain control,default high disable
		Address 26H

Bit(s)	R/W	Name	Description
7-4		VAUXL[3:0]	L-AUX volume control
3-0		VAUXR[3:0]	R-AUX volume control

Address **27H**

Bit(s)	R/W	Name	Description
0		DMAUTO	SB16 Low/High DMA Auto detect enabled ,When high.
1		Reserved	
2		XGPBIO	general purpose bi-direction pin, when high output tri-state (default LOW)
3		Reserved	
4		Reserved	
5		XGPO1	general purpose output pin 1,this pin shared with XSPDIFO pin, and enabled when index reg. F0_bit 0 programmed high.
6-7		Reserved	

Mup401 PCI Port

Index address **40-4FH**

FM PCI Port

Index address **50-5FH**

Extension Index Register (access from SB compatible mixer port)

Index address **F0H**

Bit(s)	R/W	Name	Description
7-5		VPHONE[2:0]	Phone volume control
4		VPHOM	Phone mute control
3		VSPKM	PC-Speaker mute control,default high unmute
2		RLOOPREN	Recording R-channel enable
1		RLOOPLEN	Recording L-channel enable
0		VADMIC3	Micphone record boost, default low disable, high enable.

Index address **F8-FFH**

These 8 registers is used to programming M/N conunter by clock generator

Channel 0 Frame Register 1

 Address **80H**

Bit(s)	R/W	Name	Description
31-0	W	BASADDR0	Base address of channel 0.
	R	CURADDR0	Current address of channel 0.

Channel 0 Frame Register 2

 Address **84H**

Bit(s)	R/W	Name	Description
31-16	W	BASCNT0	Base count of samples at Codec.
15-0	W	BASCNT0	Base count of samples at Bus Master.
31-16	R	CURCNT0	Current count of samples at Codec.
15-0	R	CURCNT0	Current count of samples at Bus Master.

Channel 1 Frame Register 1

 Address **88H**

Bit(s)	R/W	Name	Description
31-0	W	BASADDR1	Base address of channel 0.
	R	CURADDR1	Current address of channel 0.

Channel 1 Frame Register 2

 Address **8CH**

Bit(s)	R/W	Name	Description
31-16	W	BASCNT1	Base count of samples at Codec.
15-0	W	BASCNT1	Base count of samples at Bus Master.
31-16	R	CURCNT1	Current count of samples at Codec.
15-0	R	CURCNT1	Current count of samples at Bus Master.

Legacy SB compatible mixer

Index	D7	D6	D5	D4	D3	D2	D1	D0
0x00	Reserved							
0x04	Wave volume left channel				Wave volume right channel			
0x0A					Mic volume			
0x22	Master volume left channel				Master volume right channel			
0x26	FM volume left channel				FM volume right channel			
0x28	Analog-CD volume left channel				Analog-CD volume right channel			
0x2E	Line-in volume left channel				Line-in volume right channel			
0x30	Reserved							
0x31	Reserved							
0x32	Reserved							
0x33	Reserved							
0x34	Reserved							
0x35	Reserved							
0x36	Reserved							
0x37	Reserved							
0x38	Reserved							
0x39	Reserved							
0x3A	Reserved							
0x3B	PC spk volume							
0x3C				Output muting controls				
				Line L	Line R	CD L	CD R	Mic
0x3D	Recording left channel controls							
		FM L	FM R	Line L	Line R	CD L	CD R	Mic
0x3E	Recording right channel controls							
		FM L	FM R	Line L	Line R	CD L	CD R	Mic
0x3F	Reserved							
0x40	Reserved							
0x41	Reserved							
0x42	Reserved							
0x43	Reserved							
0x44	Reserved							
0x45	Reserved							
0x46	Reserved							
0x47	Reserved							
0x80					IRQ channel (read only)			
					IRQ10	IRQ7	IRQ5	IRQ2(9)
0x81	16 bit DMA channel (read only)				8 bit DMA channel (read only)			
	DMA 7		DMA 5		DMA 3		DMA 1	DMA 0
0x82					Interrupt status (read only)			
					MPU-40 1	16bit DMA	8bit DMA	

● Please do not write any values into reserved registers

1. Stereo

It is only one-dimensional, as sounds come from (left /right) the physical location of speakers.

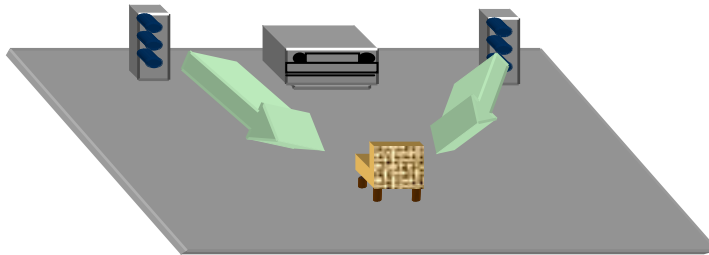

2. Surround (Stereo Expander)

It filters the existing stereo signal to make the sounds fill in the area around the speakers, and in front of the listener. Sound sources appear to come from outside the physical locations of the speakers.

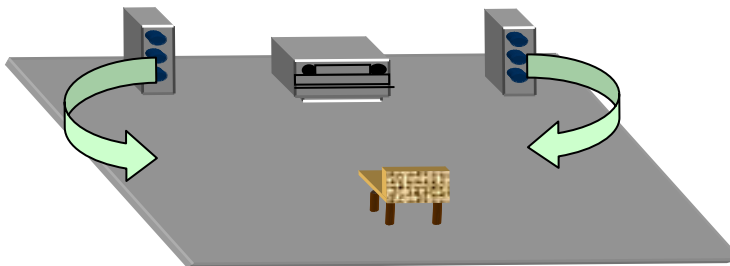

3. Multi-Speaker Surround (Dolby Pro Logic or Digital AC-3)

It uses five speakers instead of two to surround the listener; hence, sound sources come from five directions and create engaging audio experience. This surround sound effect, however, has to be pre-recorded, and it does not support interactive environment.

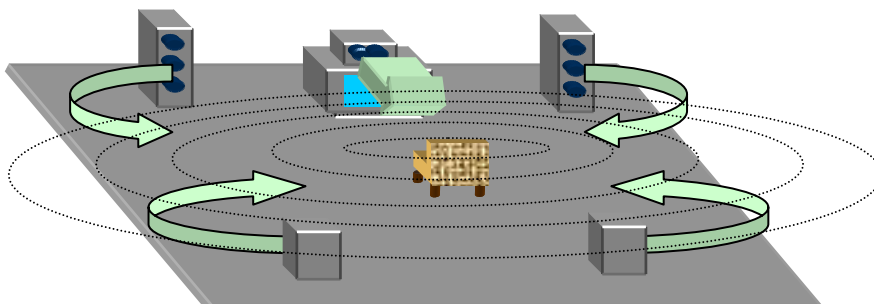

4. HRTF 3D Positional 3D (C-Media 3D)

Only this sound processing technology can be called real 3D manifestation, as 3D usually refers to the three dimensions of X, Y and Z. This technology allows people to pin-point the location of sound in the real world (up/down, left/right, front/back) using only two speakers or a pair of headphones. This technology also supports interactive 3D applications to get a real-time placement of sounds via API (application programming interface) such as Microsoft DirectSound3D™. We can also use this technology to simulate Multi-speaker Surround with two physical speakers to deliver five “virtual” speakers in the air, surrounding the listener and creating home theater sound environment. This is the most economical and the easiest solution to people who would like to get high performance surround sound but don’t want to spend money in adding extra speakers.

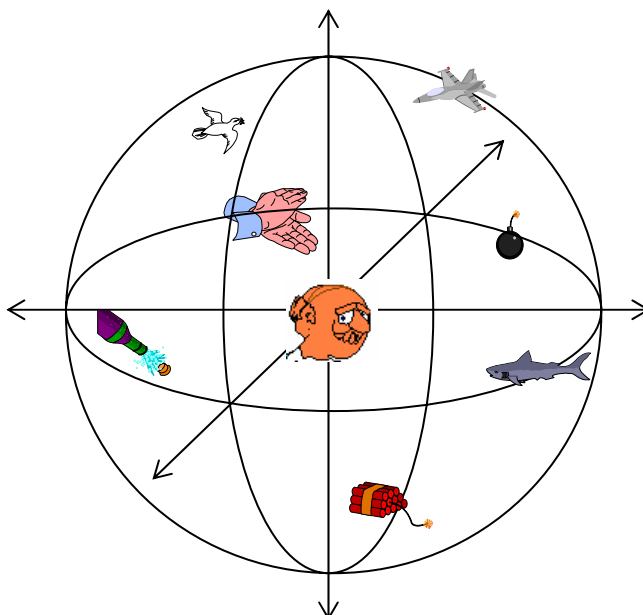
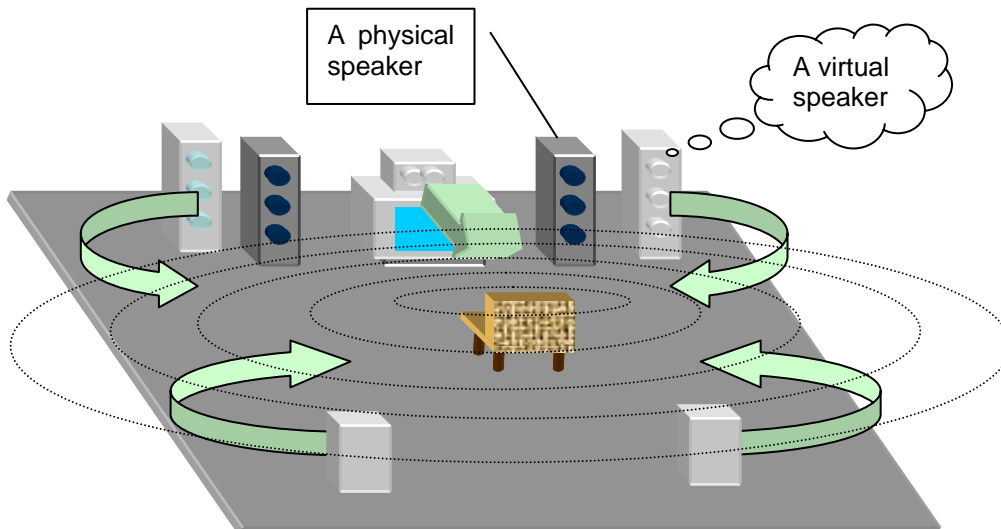

5. HRTF 3D Extension Positional (C-Media 3DX)

3D illusion exists because traditional 3D positional audio system assumes the user's position as the sweet spot to design crosstalk-cancellation circuit; therefore, if the user wants to have 3D positional audio effects, he can't move his head or position out of sweet spot. Another 3D illusion fails because half the population are compulsive "head-turners" who will never get 3D audio from two speakers. To remedy this, C-Media utilizes HRTF 3D extension technology (C3DX) to enhance traditional HRTF 3D positional audio by substituting two-speaker system by four-speaker one. Therefore, at least one or two speakers should be placed behind the listener's head to complement the rear-side effect, thus creating compelling realistic sound. This technology greatly improves HRTF 3D positional audio quality, and successfully eliminates the sweet spot limitation. Users can enjoy the real 3D audio gaming effects, and don't have to worry about the environmental confinement any more.

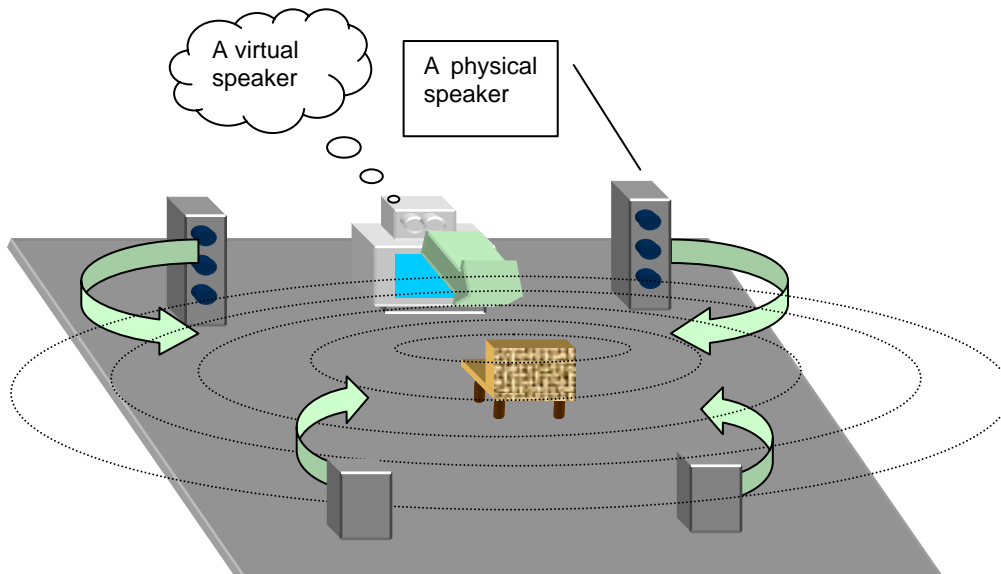

C3D HRTF Positional Audio Technology

C3D technology uses an audio filter called Head Related Transfer Functions (HRTFs), which is licensed from CRL®(Central Research Lab). The basic concept of C3D is: since we can hear sound three dimensionally in the real world using our two ears, it must be possible to regenerate the same sound effect from two loud speakers.

What is HRTF ?

HRTF (Head Related Transfer Functions) is a set of audio filters which can vary locations of sound effects (spatial hearing cues) in three-dimension measured from the listener's eardrum.

People can use this technology and special digital signal processing to re-create spatial hearing cues, so as to makes the ears hear a realistic and three-dimensional sounds coming from a pairs of loud speakers or headphones.

There are several listening cues which allow people to hear sounds three-dimensionally :

(I). Spatial Hearing : Primary 3D-cues

1. IAD

The head shadowing effect creates differences in the amplitudes of the sound signals arriving at each ear from the source. The effects of diffraction are most noticeable in the range between about 700 Hz to 8 KHz, where the A and S functions periodically converge and diverge gently. This Inter-aural Amplitude difference (IAD) is one of the primary 3D sound cues.

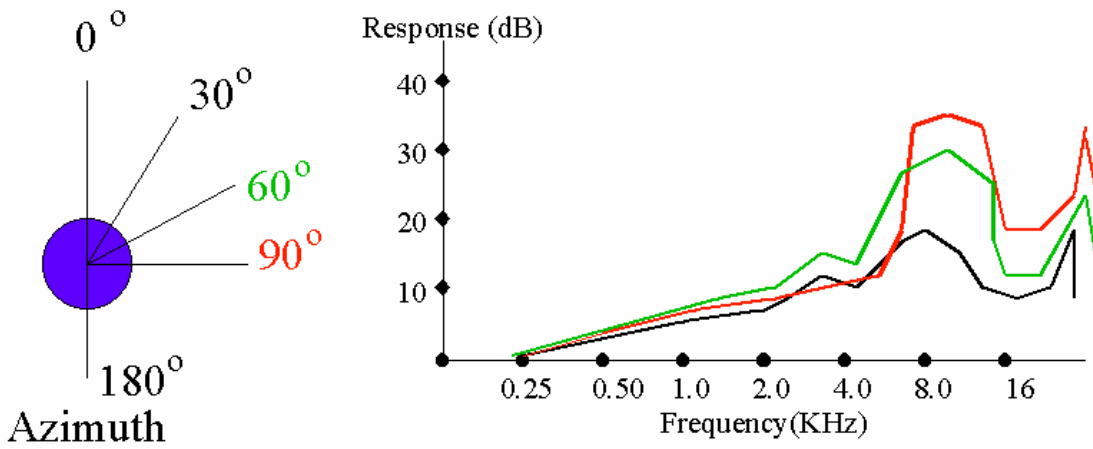

2. ITD

In addition to IAD, there is also a time-of-arrival difference between the left and right ears (unless the sound source is in one of the pole positions, such as directly in front, behind, above and below): this is known as the Inter-aural Time Delay (ITD).

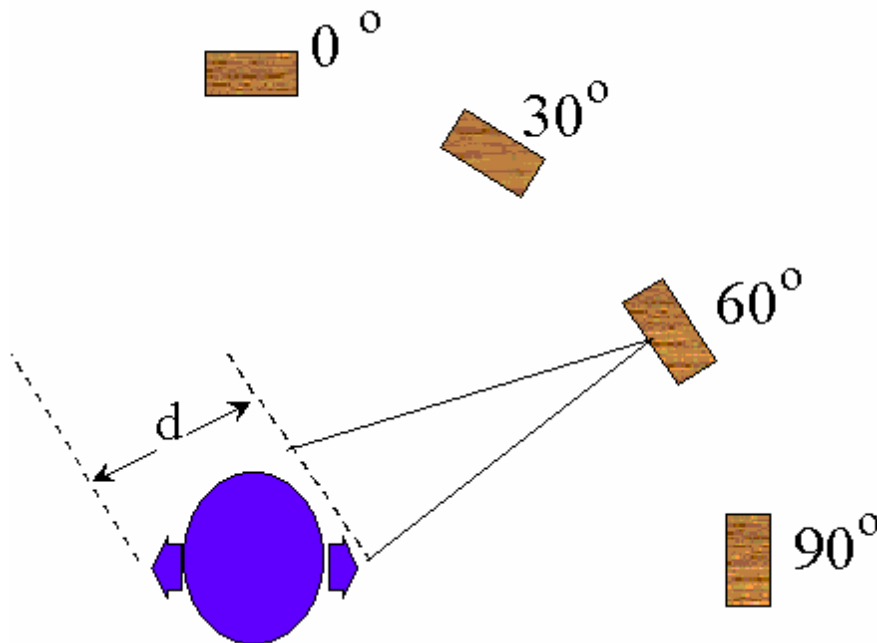

3. Pinna Effects

It has been presumed by several researchers that the convolutions of the pinna create the spectral features which constitute the 'height' cues. In practical experiments by Gardner, in which different parts of the pinna were occluded, and then the ability of a number of subjects to identify sound source positions at different heights was tested, it was shown that the different features all contributed by different amounts. For example, if the fossa is excluded, then height localization capability is impaired, but not totally extinguished. It would be reasonable to conclude that it is the combined effect of the pinna convolutions which create the various localization cues, and it is not valid - or logical - to attempt to assign particular spatial capabilities with individual physical features.

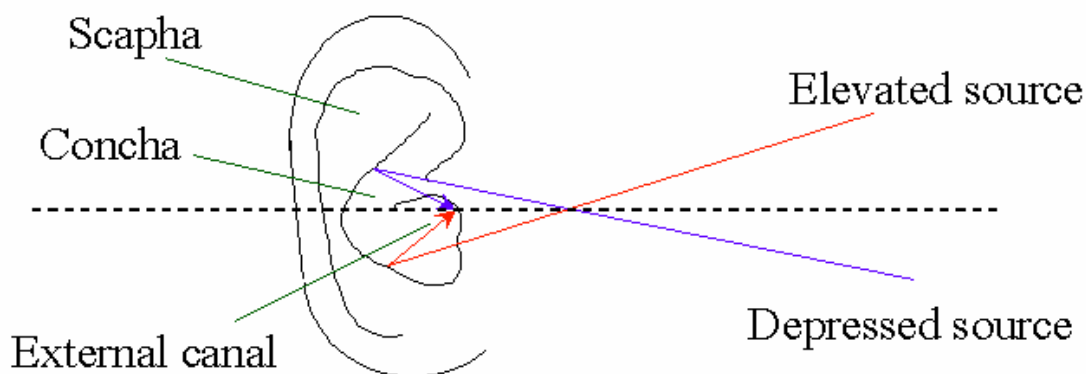

(II). Spatial Hearing : Secondary 3D-cues (shoulder & local reflections)

In addition to the 'primary' 3D sound cues (IAD, ITD and pinna effects), there are several additional cues which do contribute to the localization capability; these will be referred to here as 'secondary' cues, and include shoulder/torso reflections, local room reflections, and psychological cues.

1. Shoulder / Torso reflections

The presence of a torso attached to an artificial head has the effect of increasing the pressure in the vicinity of the ear up to frequencies of around 2 kHz. The effect is greater for frontal sources than lateral ones. In experience, the presence of the torso does not appear to contribute much to spatial accuracy. However, shoulders are located very close to the ears, and their effect is greater, this time, in respect of

HRTF 3D Positional Audio Technology White-Paper

lateral sounds. If one listens to an artificial head first without - and then with - shoulder fittings, then it is clear that the shoulders do contribute to spatial effects in certain positions. The shoulders provide a strong reflection from lateral sources, with a short path-length of around 10 cm between direct sound and reflection. The effects are most important for side-positioned sources, especially for "height" effects, where the shoulders tend to mask sources which move below about 30 degree depression.

2. Local, Room Reflections

In simulations, it is clear that the incorporation of first-order simulated room reflections can help in the creation of sound images which have a "solid" nature. However, the effects - if accurately simulated - are relatively slight. Experience has shown that it is primarily the quality of the HRTFs themselves which determine the quality and solidity of the sound image. The further addition of second-order reflections does not help significantly, because in reality, there is a great number of reflections in the average room. A method which does help to recreate the acoustic experience of a room, however, is to use approximate simulations of lateral reverb, using either 2 or 4 laterally placed "virtual" sources at, say, +-70 degrees and 80 degrees azimuth.

- The quality of the sound image relates to the HRTFs used.
- The quality of the room image relates to addition of reflections and reverb.

3. Psychological Cues

There are clearly psychological cues present in everyday life which work together with the audio cues to tell us about the world around us. For example, if you hear the sound of a helicopter flying, you expect it to be up in the air, and not downwards. If a dog is barking nearby, you would expect it to be downwards.

How to listen to C3D sound correctly and properly?

1. Use Headphones to Have Much Better Effect

When you use headphones in listening, there will be less interference such as outside voices or room reflections comparing to using speakers.

2. Choose Correct Output Devices

Choose the correct output devices in the options of demo program in accordance with what listening devices you want to listen to. Listening through speakers must be proceeded by crosstalk-cancellation, so if you choose the wrong output devices, there won't be any 3D positional audio effect.

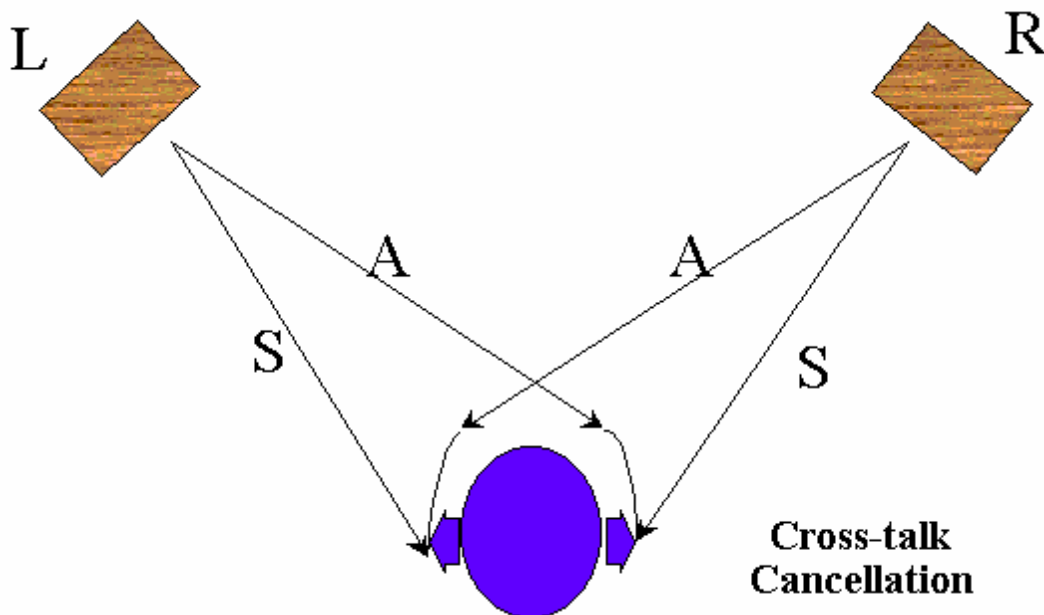

3. Position of Speakers

If you listen from speakers, please do not reverse the left and right speakers, which should be put in equal distance from the listener. That is, the listener, the left, and the right speaker must be in the topmost of a right triangle. The position of the listener is called the “sweet spot”. In addition, the height of the listener’s ears must be equal to that of the speakers.

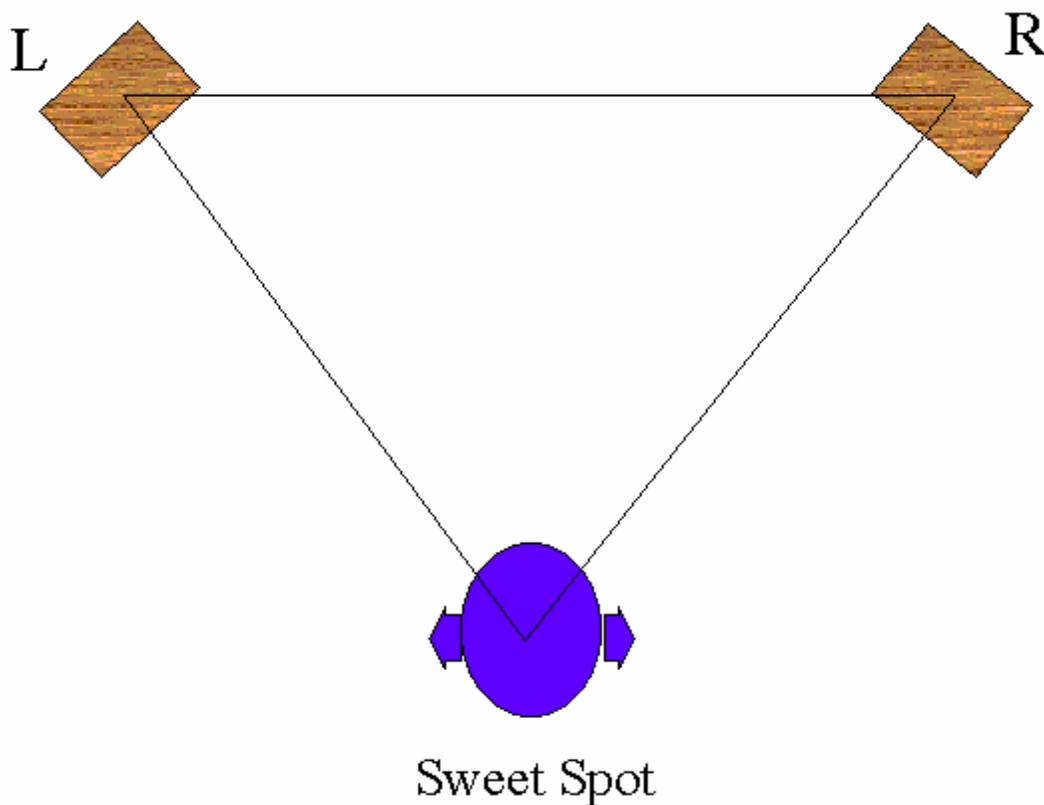

4. Turn Surround Sound Functions off

When the surround sound effect is enabled, it will cause confusion with C3D sound, and make positional sound effect invalid.

Audio Rack Panel



Two Speakers System :

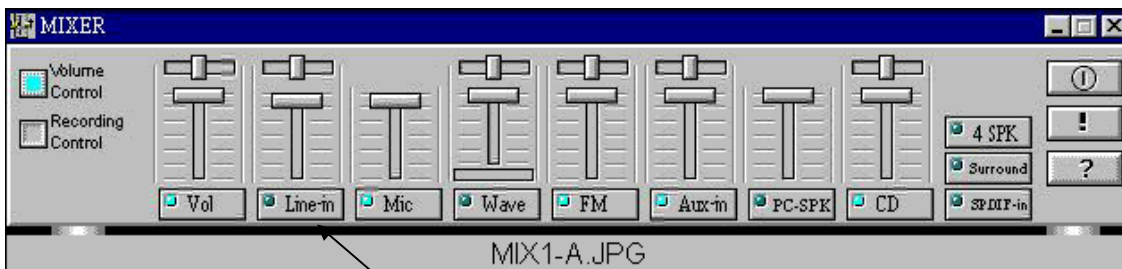

Line-In becomes
Rear Speakers Output

4 Speakers
system Enable

Four Speakers System:



CMI8738 PCI Audio Adapter Layout Notes

1. The wires of analog circuits(chip pin64-80) must be wider than 12mil.
2. The whole PCB grounding should be well-organized(The ground must be placed as much as possible. Also, the ground of both the component and the solder sides should be drilled as much as possible.).
3. The grounding under CMI8738 should be well-organized as mentioned above.
4. The regulator(78L05) must be placed near the chip as much as possible.
5. The chip and the circuits need independent power supply regulators to prevent insufficient currents.