

**LITEON****LTS-6000 SERIES****0.56 SINGLE DIGIT NUMERIC DISPLAYS**

T-41-33

**FEATURES**

- 0.56 INCH (14.2mm) DIGIT HEIGHT.
- CHOICE OF SIX BRIGHT COLORS-RED/BRIGHT RED / GREEN / YELLOW/ORANGE/HIGH EFFICIENCY RED.
- LOW POWER REQUIREMENT.
- EXCELLENT CHARACTERS APPEARANCE.
- CATEGORIZED FOR LUMINOUS INTENSITY.
- I.C. COMPATIBLE.
- EASY MOUNTING ON P.C. BOARD OR SOCKETS.

**DESCRIPTION**

The LTS-6000, series are 0.56 inch (14.2mm) height single digit displays.

The red series devices utilize LED chips which are made from GaAsP on a GaAs substrate. The bright red and green series devices utilize LED chips which are made from GaP on a transparent GaP substrate. The yellow, orange and high efficiency red series devices utilize LED chips which are made from GaAsP on a transparent GaP substrate. Red and bright red displays have black face and red segment color. Green and yellow displays have gray face and white segment color. Orange displays have orange face and orange segment color. High efficiency red displays have red face and red segment color.

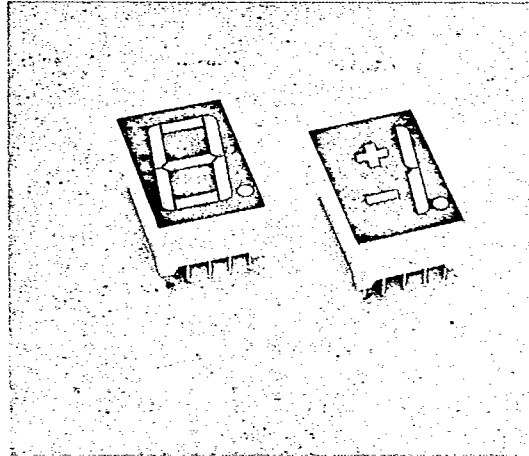
**DEVICES**

PART NO.						DESCRIPTION	INTERNAL CIRCUIT DIAGRAM
RED	BRIGHT RED	GREEN	YELLOW	ORANGE	HI. EFF. RED		
LTS-6760R	6760P	6460G	6860Y	6660E	6960HR	Common Anode, Rt. Hand Decimal	A
LTS-6780R	6780P	6480G	6880Y	6680E	6980HR	Common Cathode, Rt. Hand Decimal	B
LTS-6775R	6775P	6475G	6875Y	6675E	6975HR	Common Anode, ±1 Overflow	C
LTS-6795R	6795P	6495G	6895Y	6695E	6995HR	Common Cathode, ±1 Overflow	D

PACKAGE DIMENSION

LTS-6x60/6x80/6x75/6x95

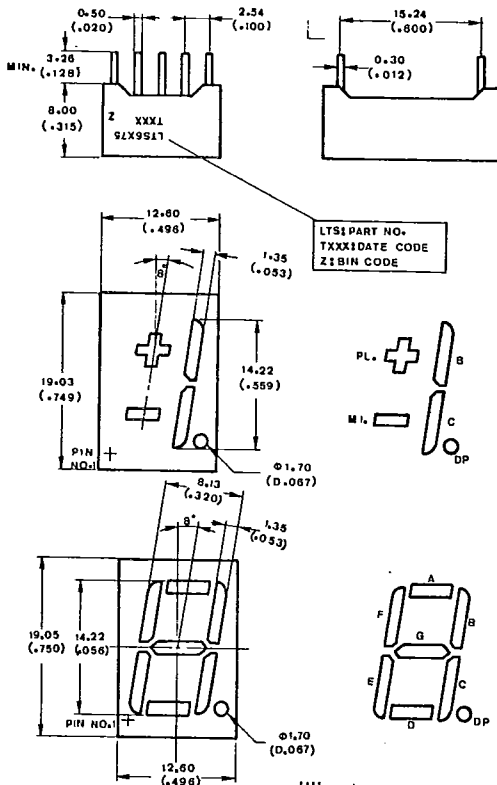

LTS PART NO.  
TXXX DATE CODE  
ZI BIN CODE

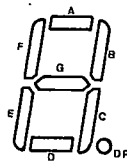
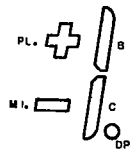

NOTE: All dimensions are in millimeters (inches) tolerance are:

1. Lead length (from seating plane): minimum value  $\frac{+1.00}{-0.00}$  mm ( $\frac{+0.040''}{-0.000''}$ ) 2.  $\pm 0.25$ mm (0.010'')

INTERNAL CIRCUIT DIAGRAM

A. LTS-6x60

B. LTS-6x80

C. LTS-6x75

D. LTS-6x95

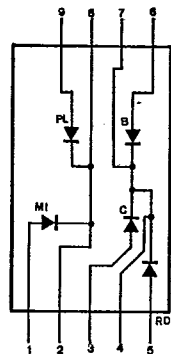
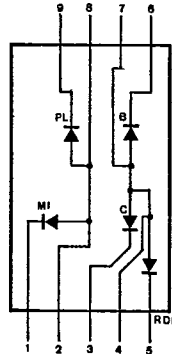
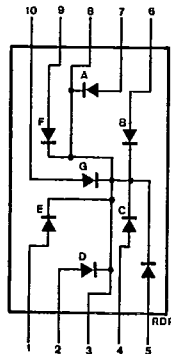
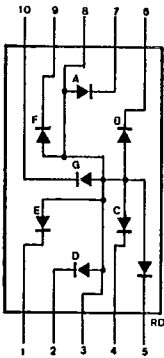

5-70  
733

## PIN CONNECTION

PIN NO.	CONNECTION			
	A. LTS-6x60	B. LTS-6x80	C. LTS-6x75	D. LTS-6x95
1	Cathode E	Anode E	Cathode Minus Sign	Anode Minus Sign
2	Cathode D	Anode D	Anode Pl., Mi. *2	Cathode Pl., Mi. *2
3	Common Anode *1	Common Cathode *1	Cathode C	Anode C
4	Cathode C	Anode C	Anode B.C.Dp *3	Cathode B.C.Dp *3
5	Cathode D.P.	Anode D.P.	Cathode Cp	Anode Dp
6	Cathode B	Anode B	Cathode B	Anode B
7	Cathode A	Anode A	Anode B.C.Dp *3	Cathode B.C.Dp *3
8	Common Anode *1	Common Cathode *1	Anode Pl., Mi. *2	Cathode Pl., Mi. *2
9	Cathode F	Anode F	Cathode Plus Sign	Anode Plus Sign
10	Cathode G	Anode G	No Connection	No Connection

- NOTES: 1. Pin 3 & 8 are internally connected.  
 2. Pin 2 & 8 are internally connected.  
 3. Pin 4 & 7 are internally connected.

ABSOLUTE MAXIMUM RATINGS AT  $T_A = 25^\circ\text{C}$ 

PARAMETER	RED	BRIGHT RED	GREEN	YELLOW	ORANGE	HI.-EFF. RED	UNIT
Power Dissipation Per Segment	55	40	75	60	75	75	mW
Peak Forward Current Per Segment (1/10 Duty Cycle, 0.1ms Pulse Width)	160	60	100	80	100	100	mA
Continuous Forward Current Per Segment	25	15	25	20	25	25	mA
Derating Linear From $25^\circ\text{C}$ Per Segment	0.3	0.18	0.3	0.24	0.3	0.3	mA/ $^\circ\text{C}$
Reverse Voltage Per Segment	5	5	5	5	5	5	V
Operating Temperature Range	-25 $^\circ\text{C}$ to +85 $^\circ\text{C}$						
Storage Temperature Range	-25 $^\circ\text{C}$ to +85 $^\circ\text{C}$						
Solder Temperature 1/16 inch Below Seating Plane for 3 Seconds at 260 $^\circ\text{C}$							

**ELECTRICAL/OPTICAL CHARACTERISTICS AT TA = 25°C**  
**LTS-6700R SERIES**

PARAMETER	SYMBOL	MIN.	TYP.	MAX.	UNIT	TEST CONDITION
Average Luminous Intensity	I <sub>v</sub>	200	600		μcd	I <sub>F</sub> = 10 mA
Peak Emission Wavelength	λ <sub>P</sub>		655		nm	I <sub>F</sub> = 20 mA
Spectral Line Half-Width	Δλ		24		nm	I <sub>F</sub> = 20 mA
Forward Voltage, any Segment or D.P.	V <sub>F</sub>		1.7	2.0	V	I <sub>F</sub> = 20 mA
Reverse Current, any Segment or D.P.	I <sub>R</sub>			100	μA	V <sub>R</sub> = 5 V
Luminous Intensity Matching Ratio	I <sub>v</sub> -m			2:1		I <sub>F</sub> = 20 mA

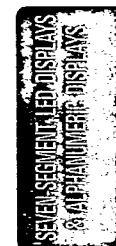

**TYPICAL ELECTRICAL/OPTICAL CHARACTERISTIC CURVES**

(25°C Ambient Temperature Unless Otherwise Noted)

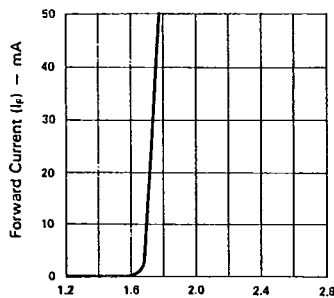

Forward Voltage (V<sub>f</sub>) - Volts  
 Fig. 1 FORWARD CURRENT vs. FORWARD VOLTAGE.

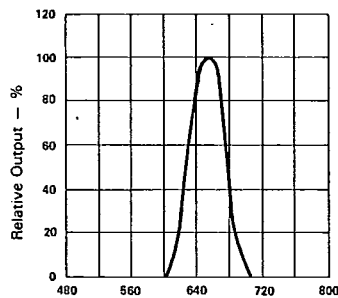

Wavelength (λ) - nm.  
 Fig. 2 SPECTRAL RESPONSE.

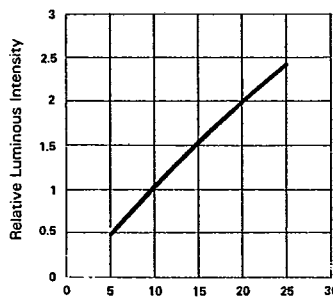

Forward Current (I<sub>f</sub>) - mA  
 Fig. 3 RELATIVE LUMINOUS INTENSITY vs. FORWARD CURRENT (PER SEGMENT).

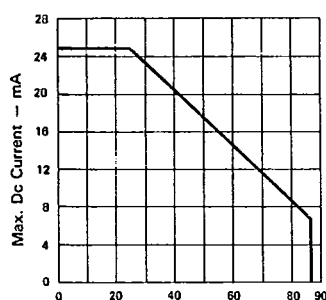

Ambient Temperature (T<sub>a</sub>) - °C  
 Fig. 4 MAX. ALLOWABLE DC CURRENT PER SEG. vs AMBIENT TEMPERATURE.

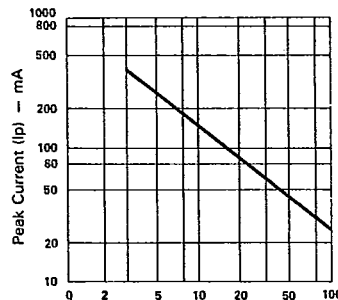

Duty Cycle %  
 Fig. 5 MAX. PEAK CURRENT vs. DUTY CYCLE% (REFRESH RATE - F = 1 KHz)

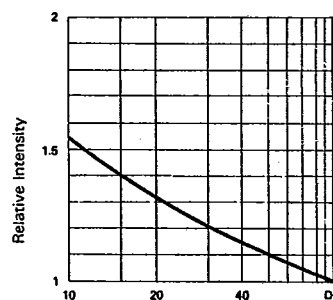

Duty Cycle %  
 Fig. 6 LUMINOUS INTENSITY vs. DUTY CYCLE% (AVERAGE I<sub>f</sub> = 10mA PER SEG.)

**ELECTRICAL/OPTICAL CHARACTERISTICS AT  $T_A = 25^\circ\text{C}$   
LTS-6700P SERIES**

PARAMETER	SYMBOL	MIN.	TYP.	MAX.	UNIT	TEST CONDITION
Average Luminous Intensity	$I_v$	300	950		$\mu\text{cd}$	$I_F = 10 \text{ mA}$
Peak Emission Wavelength	$\lambda_P$		697		nm	$I_F = 20 \text{ mA}$
Spectral Line Half-Width	$\Delta\lambda$		90		nm	$I_F = 20 \text{ mA}$
Forward Voltage, any Segment or D.P.	$V_F$		2.1	2.8	V	$I_F = 20 \text{ mA}$
Reverse Current, any Segment or D.P.	$I_R$			100	$\mu\text{A}$	$V_R = 5 \text{ V}$
Luminous Intensity Matching Ratio	$I_v\text{-m}$			2:1		$I_F = 20 \text{ mA}$

**TYPICAL ELECTRICAL/OPTICAL CHARACTERISTIC CURVES**

( $25^\circ\text{C}$  Ambient Temperature Unless Otherwise Noted)

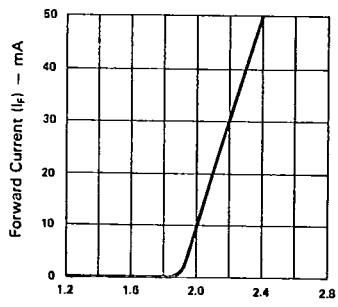

Fig. 1 FORWARD CURRENT Vs. FORWARD VOLTAGE.

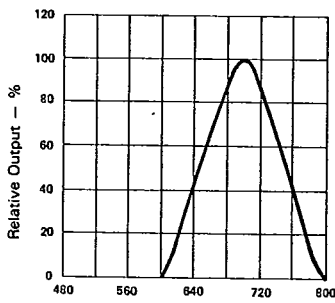

Fig. 2 SPECTRAL RESPONSE.

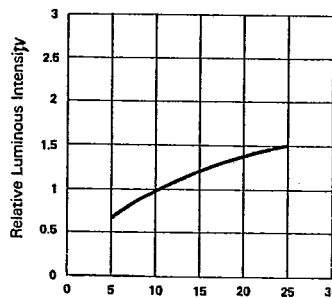

Fig. 3 RELATIVE, LUMINOUS INTENSITY Vs. FORWARD CURRENT (PER SEGMENT).

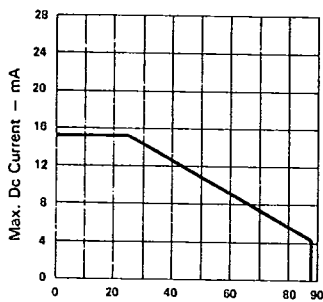

Fig. 4 MAX. ALLOWABLE DC CURRENT PER SEG. Vs AMBIENT TEMPERATURE.

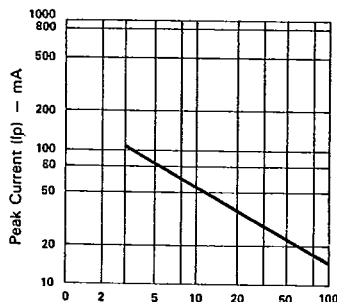
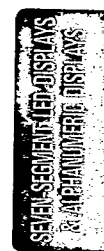

Fig. 5 MAX. PEAK CURRENT Vs. DUTY CYCLE.% (REFRESH RATE -  $F = 1 \text{ KHz}$ )

**ELECTRICAL/OPTICAL CHARACTERISTICS AT  $T_A = 25^\circ\text{C}$   
LTS-6400G SERIES**

PARAMETER	SYMBOL	MIN.	TYP.	MAX.	UNIT	TEST CONDITION
Average Luminous Intensity	$I_v$	800	2400		$\mu\text{cd}$	$I_F = 10 \text{ mA}$
Peak Emission Wavelength	$\lambda_P$		565		nm	$I_F = 20 \text{ mA}$
Spectral Line Half-Width	$\Delta\lambda$		30		nm	$I_F = 20 \text{ mA}$
Forward Voltage, any Segment or D.P.	$V_F$		2.1	2.8	V	$I_F = 20 \text{ mA}$
Reverse Current, any Segment or D.P.	$I_R$			100	$\mu\text{A}$	$V_R = 5 \text{ V}$
Luminous Intensity Matching Ratio	$I_v\text{-m}$			2:1		$I_F = 20 \text{ mA}$



**TYPICAL ELECTRICAL/OPTICAL CHARACTERISTIC CURVES**

( $25^\circ\text{C}$  Ambient Temperature Unless Otherwise Noted)

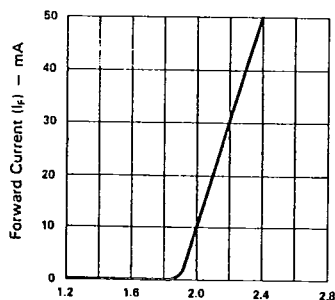

Forward Voltage ( $V_F$ ) - Volts  
Fig. 1 FORWARD CURRENT Vs. FORWARD VOLTAGE.

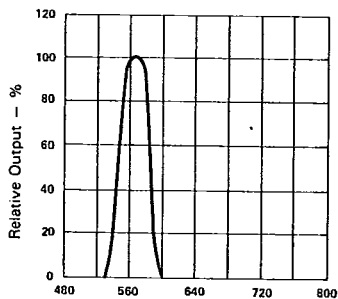

Wavelength ( $\lambda$ ) - nm.  
Fig. 2 SPECTRAL RESPONSE.

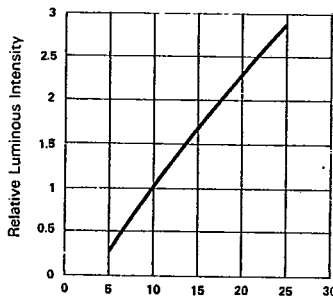

Forward Current ( $I_F$ ) - mA  
Fig. 3 RELATIVE LUMINOUS INTENSITY Vs. FORWARD CURRENT (PER SEGMENT).

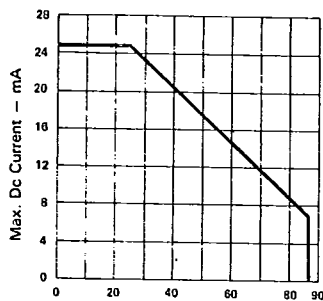

Ambient Temperature ( $T_A$ ) -  $^\circ\text{C}$   
Fig. 4 MAX. ALLOWABLE DC CURRENT PER SEG. Vs AMBIENT TEMPERATURE.

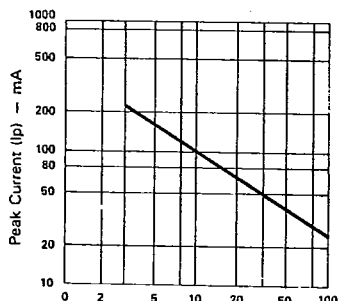

Duty Cycle %  
Fig. 5 MAX. PEAK CURRENT Vs. DUTY CYCLE% (REFRESH RATE -  $F = 1 \text{ KHz}$ )

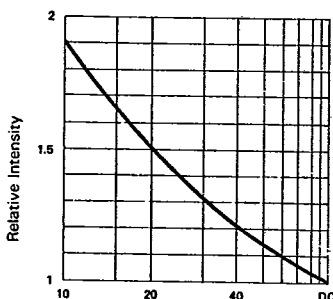

Duty Cycle %  
Fig. 6 LUMINOUS INTENSITY Vs. DUTY CYCLE% (AVERAGE  $I_F = 10\text{mA}$  PER SEG.)

5-74

737

**ELECTRICAL/OPTICAL CHARACTERISTICS AT  $T_A = 25^\circ\text{C}$**   
**LTS-6800Y**

PARAMETER	SYMBOL	MIN.	TYP.	MAX.	UNIT	TEST CONDITION
Average Luminous Intensity	$I_v$	800	2400		$\mu\text{cd}$	$I_F = 10 \text{ mA}$
Peak Emission Wavelength	$\lambda_P$		585		nm	$I_F = 20 \text{ mA}$
Spectral Line Half-Width	$\Delta\lambda$		35		nm	$I_F = 20 \text{ mA}$
Forward Voltage, any Segment or D.P.	$V_F$		2.1	2.8	V	$I_F = 20 \text{ mA}$
Reverse Current, any Segment or D.P.	$I_R$			100	$\mu\text{A}$	$V_R = 5 \text{ V}$
Luminous Intensity Matching Ratio	$I_v\text{-m}$			2:1		$I_F = 20 \text{ mA}$

**TYPICAL ELECTRICAL/OPTICAL CHARACTERISTIC CURVES**  
 (25°C Ambient Temperature Unless Otherwise Noted)

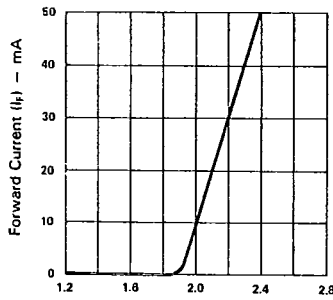

Fig. 1 FORWARD CURRENT VS. FORWARD VOLTAGE.

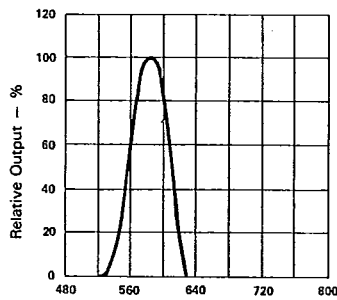

Fig. 2 SPECTRAL RESPONSE.

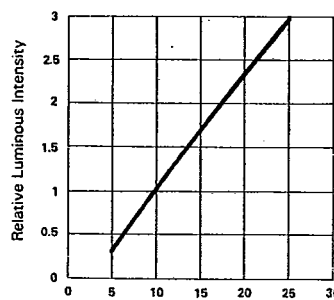

Fig. 3 RELATIVE LUMINOUS INTENSITY VS. FORWARD CURRENT (PER SEGMENT).

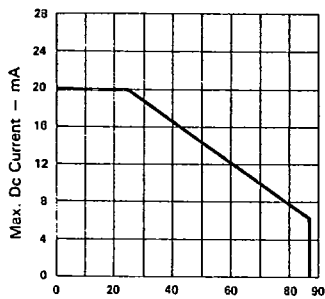

Fig. 4 MAX. ALLOWABLE DC CURRENT PER SEG. VS AMBIENT TEMPERATURE.

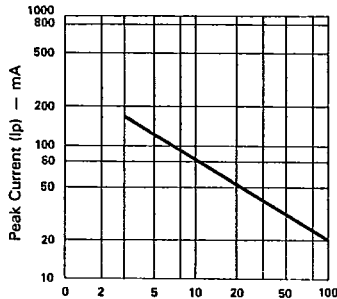

Fig. 5 MAX. PEAK CURRENT VS. DUTY CYCLE.% (REFRESH RATE - F = 1 KHz)

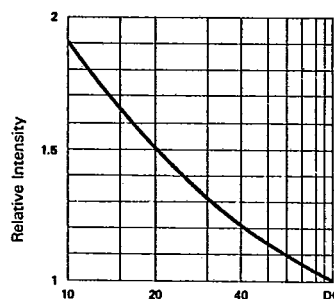

Fig. 6 LUMINOUS INTENSITY VS. DUTY CYCLE% (AVERAGE  $I_F = 10\text{mA}$  PER SEG.)

**ELECTRICAL/OPTICAL CHARACTERISTICS AT TA = 25°C**  
**LTS-6600E SERIES**

PARAMETER	SYMBOL	MIN.	TYP.	MAX.	UNIT	TEST CONDITION
Average Luminous Intensity	Iv	800	2400		μcd	IF = 10 mA
Peak Emission Wavelength	λP		630		nm	IF = 20 mA
Spectral Line Half-Width	Δλ		45		nm	IF = 20 mA
Forward Voltage, any Segment or D.P.	VF		2.1	2.8	V	IF = 20 mA
Reverse Current, any Segment or D.P.	IR			100	μA	VR = 5 V
Luminous Intensity Matching Ratio	Iv-m			2:1		IF = 20 mA

**TYPICAL ELECTRICAL/OPTICAL CHARACTERISTIC CURVES**  
 (25°C Ambient Temperature Unless Otherwise Noted)

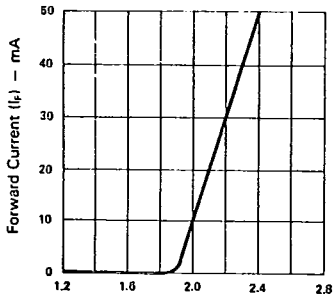

Fig. 1 FORWARD CURRENT Vs. FORWARD VOLTAGE.

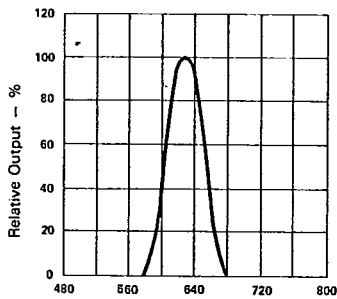

Fig. 2 SPECTRAL RESPONSE.

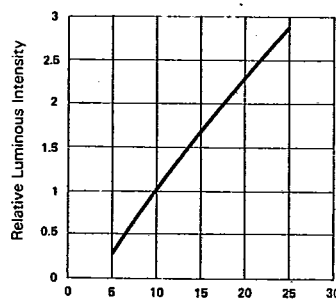

Fig. 3 RELATIVE, LUMINOUS INTENSITY Vs. FORWARD CURRENT (PER SEGMENT).

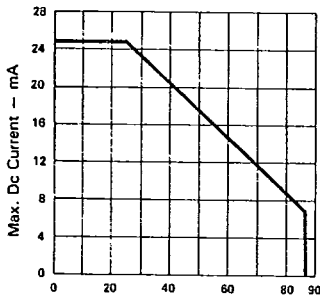

Fig. 4 MAX. ALLOWABLE DC CURRENT PER SEG. Vs AMBIENT TEMPERATURE.

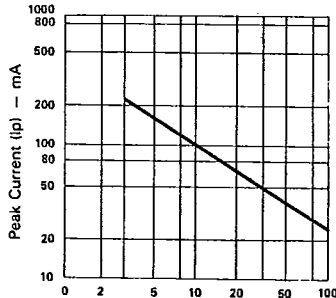

Fig. 5 MAX. PEAK CURRENT Vs. DUTY CYCLE.% (REFRESH RATE - F = 1 KHz)

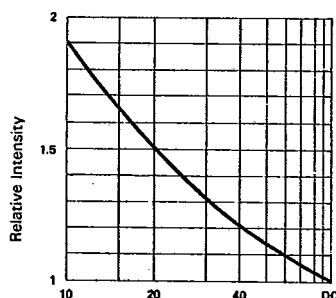

Fig. 6 LUMINOUS INTENSITY Vs. DUTY CYCLE.% (AVERAGE IF = 10mA PER SEG.)



**ELECTRICAL/OPTICAL CHARACTERISTICS AT TA = 25°C  
LTS-6900HR SERIES**

PARAMETER	SYMBOL	MIN.	TYP.	MAX.	UNIT	TEST CONDITION
Average Luminous Intensity	$I_v$	800	2400		$\mu\text{cd}$	$I_F = 10 \text{ mA}$
Peak Emission Wavelength	$\lambda_P$		635		nm	$I_F = 20 \text{ mA}$
Spectral Line Half-Width	$\Delta\lambda$		45		nm	$I_F = 20 \text{ mA}$
Forward Voltage, any Segment or D.P.	$V_F$		2.1	2.8	V	$I_F = 20 \text{ mA}$
Reverse Current, any Segment or D.P.	$I_R$			100	$\mu\text{A}$	$V_R = 5 \text{ V}$
Luminous Intensity Matching Ratio	$I_v\text{-m}$			2:1		$I_F = 20 \text{ mA}$

**TYPICAL ELECTRICAL/OPTICAL CHARACTERISTIC CURVES**

(25°C Ambient Temperature Unless Otherwise Noted)

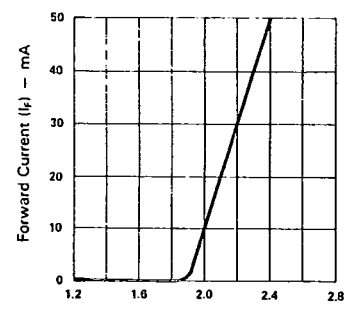

Fig. 1 FORWARD CURRENT Vs. FORWARD VOLTAGE.

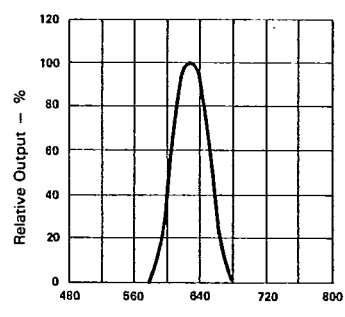

Fig. 2 SPECTRAL RESPONSE.

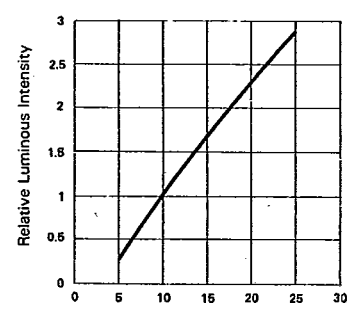

Fig. 3 RELATIVE, LUMINOUS INTENSITY Vs. FORWARD CURRENT (PER SEGMENT).

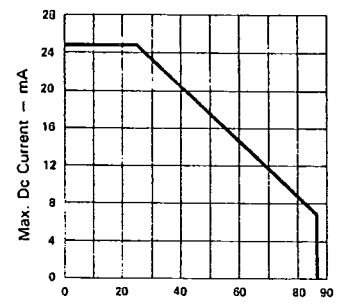

Fig. 4 MAX. ALLOWABLE DC CURRENT PER SEG. Vs AMBIENT TEMPERATURE.

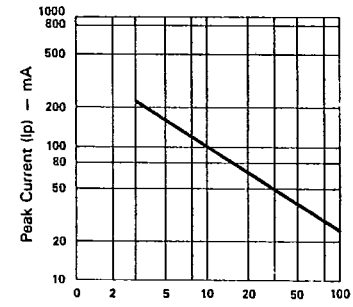

Fig. 5 MAX. PEAK CURRENT Vs. DUTY CYCLE.% (REFRESH RATE - F = 1 KHz)

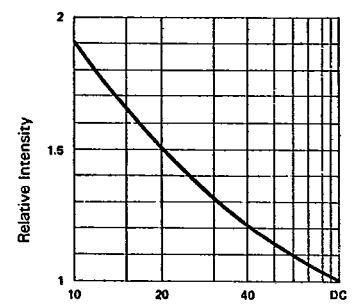

Fig. 6 LUMINOUS INTENSITY Vs. DUTY CYCLE% (AVERAGE  $I_f = 10\text{mA}$  PER SEG.)

# PACKAGING

T-90-20

## Reel Packaging (Axial Lead Units)

DEVICE TYPE	COMPONENT SPACE (MM) "A"	TAPE SPACE (MM) "B"	REEL DIA (MM) "D"	QUANTITY (EA)		CARTON	
				REEL	CARTON	SIZE (MM)	WEIGHT (KG)
DO-41 DO-41L	5±0.5	52.4±1.5	326~336	5000	20K	355 x 355 x 355	10.5
DO-201AD	10±0.5	52.4±1.5	326~336	1200	4.8K	355 x 355 x 355	9.0
P6(Aleg)	10±0.5	52.4±1.5	326~336	700	2.8K	355 x 355 x 355	8.8

The C dimension of Fig. 3 is between 3.17mm and 635mm greater than the length of the component involved.

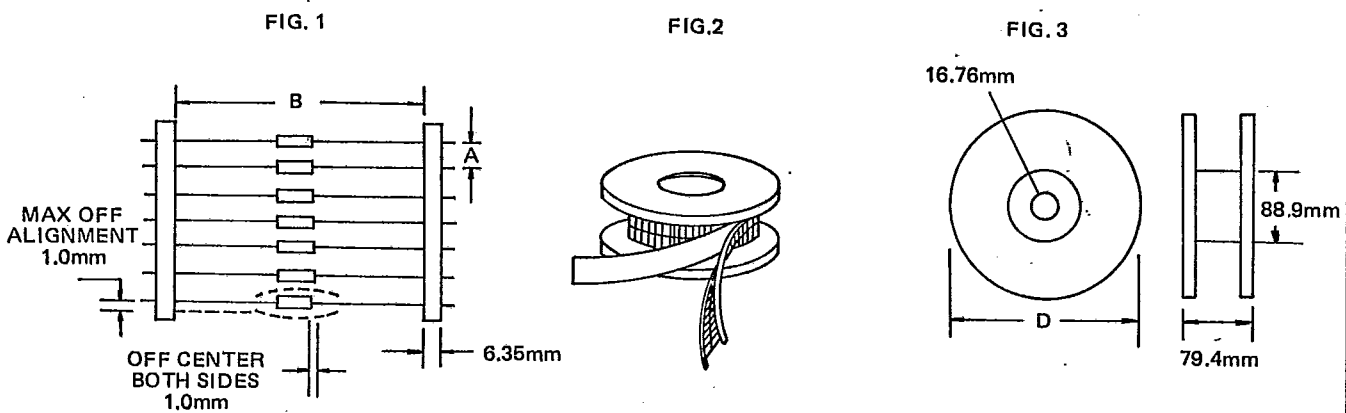

## Bulk Packaging (Axial Lead Devices and Bridge Rectifiers)

DEVICE TYPE	PACKAGING SIZE (MM)		QUANTITY (EA)		APPROX GROSS WEIGHT (KG)	
	BOX	CARTON	BOX	CARTON	BOX	CARTON
DO-41 DO-41L	196 x 84 x 20	450 x 210 x 250	1000	50K	0.38	20
DO-201AD	305 x 93 x 59	355 x 355 x 355	1000	20K	1.35	28
P6(Aleg)	305 x 93 x 59	355 x 355 x 355	500	10K	1.2	24.5
PBM	357 x 125 x 60	530 x 360 x 340	1000	20K	1.5	32.3
PBDF	495 x 155 x 145	500 x 325 x 305	5000	20K	5.1	21.5
PBP	357 x 125 x 60	530 x 360 x 340	500	10K	1.5	31.5
PBL	375 x 220 x 155	470 x 385 x 455	1000	5K	5.7	30.5
PBPC-6	357 x 125 x 60	560 x 360 x 340	250	5K	1.1	22
PBPC-8	357 x 125 x 60	560 x 360 x 340	250	5K	1.7	35
KBPC	375 x 220 x 365	470 x 390 x 385	500	1K	15.1	31.5
KBPC-W	375 x 220 x 365	470 x 390 x 385	500	1K	14.5	30.0

**AMMO BOX PACKAGING**

**BOX SIZE**

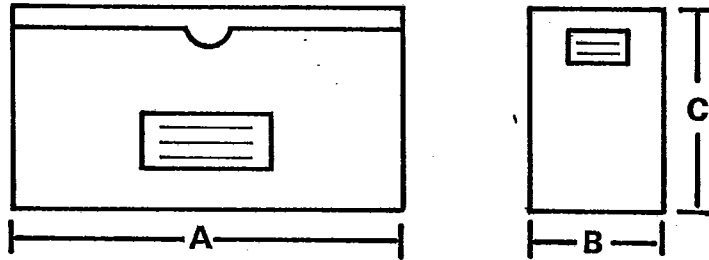

Unit:m. m.

Packaging	Products Outline	Dimension *A*	Dimension *B*	Dimension *C*	Q'ty per BOX
26MM Horizontal Ammo Pack	DO-41 DO-41L(0.6mm Lead)	255	50	95	3K
					3K
52MM Horizontal Ammo Pack	DO-41and DO-41L DO 201AD	250	75	92	3K
					0.8K

**CARTON SIZE**

Unit:m. m.

Packaging	Products Outline	length	Width	High	Q'ty Per Carton
26MM Horizontal Ammo Pack	DO-41 DO-41L(0.6mm Lead)	330	310	268	42K
					48K
52MM Horizontal Ammo Pack	DO-41and DO-41L DO 201AD	355	355	340	12K

# PREFORMED LEAD DRAWING

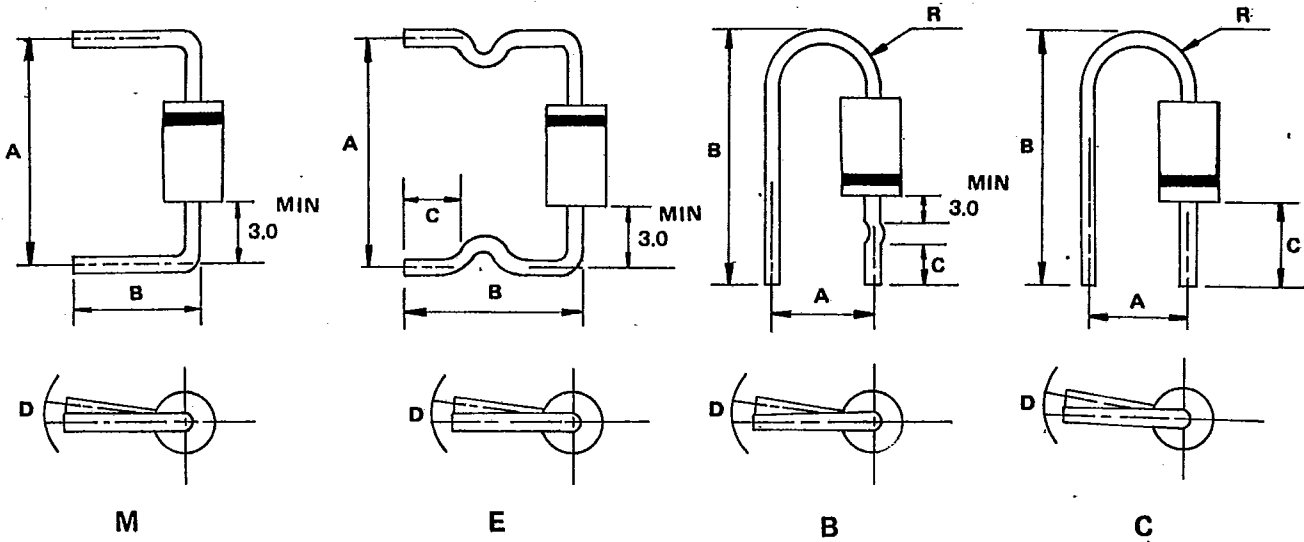

Case type	Preformed type	A (mm)		B (mm)		C (mm)		D (mm)		R (mm)	
		range	tolerance	range	tolerance	range	tolerance	range	tolerance	range	tolerance
D041	M	9.0-20.0	1.0	8.0-22.0	±0.5	-	-	1.5	max	-	-
	E	11.0-20.0	±1.0	11.0-16.0	±1.0	4.0-5.0	±0.5	1.5	max	-	-
	B	7.5	±0.5	19.0-22.0	±0.5	7.5	±0.5	1.5	max	2.5-4.0	Typ
	C	4.5	±0.8	18.0-19.0	±0.5	9.0	±0.5	1.5	max	2.5-4.0	Typ
D0201AD	M	15.0-20.0	±1.0	8.0-22.0	±1.0	-	-	2.0	max	-	-
	E	15.0-20.0	±1.0	10.0-22.0	±1.0	3.0-15.0	±0.5	2.0	max	-	-
P6(Aleg)	M	15.0-20.0	±1.0	8.0-22.0	±1.0	-	-	2.0	max	-	-