

30A – 800A

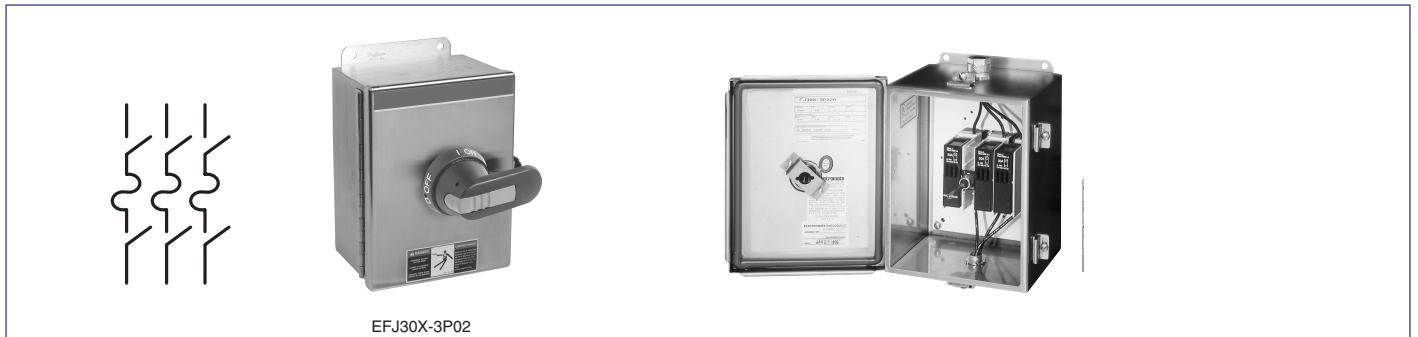

EFJ30X-3P02

3 Pole^①, 600V, 30A - 3150A

UL general purpose amp rating	Fuse type	NEMA Enclosure type			
		1	3R	4	4X Stainless
		Catalog number	Catalog number	Catalog number	Catalog number
30	J	EFJ301-3PB6	EFJ303-3PB6	EFJ304-3PB6	EFJ30X-3PB6
30	CC	EFC301-3PB6	EFC303-3PB6	EFC304-3PB6	EFC30X-3PB6
60	J ^②	EFJ601-3PB6	EFJ603-3PB6	EFJ604-3PB8	EFJ60X-3PB8
100	J ^②	EFJ1001-3PB8	EFJ1003-3PB8	EFJ1004-3PB8	EFJ100X-3PB8
200	J ^②	EFJ2001-3PB4	EFJ2003-3PB4	EFJ2004-3PB4	EFJ200X-3PB4
400	J ^②	EFJ4001-3PB4	EFJ4003-3PB4	EFJ4004-3PB4	EFJ400X-3PB4
600	J ^②	EFJ6001-3PB4	EFJ6003-3PB4	EFJ6004-3PB4	EFJ600X-3PB4
800	J ^②	EFL8001-3PB4	EFL8003-3PB4	EFL8004-3PB4	EFL800X-3PB4

Switch ratings

UL general purpose amp rating	Maximum horsepower rating								Wire size for terminal lugs	For wire type	Approval ^①
	Single phase			Three phase							
	120V	200V	240V	200V	208V	240V	480V	600V			
30	2	3	5	5	7.5	7.5	15	20	#18 – 8	Cu	CSA, UL
60	3	7.5	10	15	15	15	30	50	#14 – 4	Cu	CSA, UL
100	5	10	15	25	25	30	60	75	#14 – 2/0	Cu/Al	CSA, UL
200	—	—	—	50	50	60	125	150	#6 – 300 kcmil	Cu/Al	CSA, UL
400	—	—	—	100	125	125	250	350	#2 – 600 kcmil	Cu/Al	CSA, UL
600	—	—	—	150	150	200	400	500	(2) #2 – 600 kcmil	Cu/Al	CSA, UL
800	—	—	—	200	200	250	500	600	(2) #2 – 600 kcmil	Cu/Al	CSA, UL

^① Fusible switches are UL listed to the UL98 standard.

^② 600V T type fuse clips may be substituted at no charge. Please change the second character of the catalog number from "J" to "T."

30A – 800A



EFJ607-3P

3 Pole^①, 600V, 30A – 3150A

UL general purpose amp rating	Fuse type	NEMA / UL Enclosure type			
		4X Plastic	12	7 & 9	
		Catalog number	Catalog number	Catalog number	
	30	J	EFJ30P-3PB6	EFJ302-3PB6	EFJ307-3PB
	30	CC	EFC30P-3PB6	EFC302-3PB6	EFC307-3PB
	60	J ^②	EFJ60P-3PB8	EFJ602-3PB6	EFJ607-3PB
	100	J ^②	EFJ100P-3PB8	EFJ1002-3PB8	EFJ1007-3PB
	200	J ^②	EFJ200P-3PB4	EFJ2002-3PB4	EFJ2007-3PB
	400	J ^②	EFJ400P-3PB4	EFJ4002-3PB4	EFJ4007-3PB
	600	J ^②	EFJ600P-3PB4	EFJ6002-3PB4	EFJ6007-3PB
	800	J ^②	EFL800P-3PB4	EFL8002-3PB4	EFL8007-3PB

Handle ratings

Amperage range	Style type	NEMA	Color	Marking	Defeatable	Padlockable	Catalog number suffix	Catalog number
30	Selector	1,3R,12	Black	0/I & OFF/ON	Yes	Yes	BJ	CDH5S
	Selector	1,3R,12	Red/Yel	0/I & OFF/ON	Yes	Yes	YJ	CDH6S
	Pistol	1,3R,12	Black	0/I & OFF/ON	Yes	Yes	B6	BDH106
	Pistol	1,3R,12	Red/Yel	0/I & OFF/ON	Yes	Yes	Y6	BDH107
	Pistol	1,3R,4,4X,12	Black	0/I & OFF/ON	Yes	Yes	B6	CDHXB65
	Pistol	1,3R,4,4X,12	Red/Yel	0/I & OFF/ON	Yes	Yes	Y6	CDHXY65
60 – 100	Pistol	1,3R,12	Black	0/I & OFF/ON	Yes	Yes	B6	BDH120
	Pistol	1,3R,12	Red/Yel	0/I & OFF/ON	Yes	Yes	Y6	BDH121
	Pistol	1,3R,12	Black	0/I & OFF/ON	Yes	Yes	B8	BDH58
	Pistol	1,3R,12	Red/Yel	0/I & OFF/ON	Yes	Yes	Y8	BDH59
	Pistol	1,3R,4,4X,12	Black	0/I & OFF/ON	Yes	Yes	B8	CDHXB86
	Pistol	1,3R,4,4X,12	Red/Yel	0/I & OFF/ON	Yes	Yes	Y8	CDHXY86
200 – 800	Pistol	1,3R,12	Black	0/I & OFF/ON	Yes	Yes	B4	BDH114
	Pistol	1,3R,12	Red/Yel	0/I & OFF/ON	Yes	Yes	Y4	BDH115
	Pistol	1,3R,12	Black	0/I & OFF/ON	Yes	Yes	B7	BDH116
	Pistol	1,3R,12	Red/Yel	0/I & OFF/ON	Yes	Yes	Y7	BDH117
	Pistol	1,3R 4,4X,12	Black	0/I & OFF/ON	Yes	Yes	B4	CDHXB12
	Pistol	1,3R,4,4X,12	Red/Yel	0/I & OFF/ON	Yes	Yes	Y4	CDHXY12
	Pistol	1,3R,4,4X,12	Black	0/I & OFF/ON	Yes	Yes	B7	CDHXB22
	Pistol	1,3R,4,4X,12	Red/Yel	0/I & OFF/ON	Yes	Yes	Y7	CDHXY22
Pistol	1,3R,4,4X,12	Metal	0/I & OFF/ON	No	Yes	8	BDH8	

① Fusible switches are UL listed to the UL98 standard.

② 600V T type fuse clips may be substituted at no charge. Please change the second character of the catalog number from "J" to "T."

for Enclosed Fusible Disconnect Switches
30A – 800A

UL general purpose amp rating	Type of Switch	NEMA Enclosure type			
		1 Catalog number	3R Catalog number	4 Catalog number	4X Stainless Catalog number
30 (J fuses)	4 Pole ^①	EFJ301-4PB6	EFJ303-4PB6	EFJ304-4PB6	EFJ30X-4PB6
	6 Pole	EFJ301-6PB6	EFJ303-6PB6	EFJ304-6PB6	EFJ30X-6PB
	Transfer	EFJ301-3TB8	EFJ303-3TB8	EFJ304-3TB8	EFJ30X-3TB8
	Bypass	EFJ301-3BB6	EFJ303-3BB6	EFJ304-3BB6	EFJ30X-3BB6
	Mech. interlock	EFJ301-3MB6	EFJ303-3MB6	EFJ304-3MB6	EFJ30X-3MB6
30 (CC fuses)	4 Pole ^①	EFC301-4PB6	EFC303-4PB6	EFC304-4PB6	EFC30X-4PB6
	6 Pole	EFC301-6PB6	EFC303-6PB6	EFC304-6PB6	EFC30X-6PB6
	Transfer	EFC301-3TB8	EFC303-3TB8	EFC304-3TB8	EFC30X-3TB8
	Bypass	EFC301-3BB6	EFC303-3BB6	EFC304-3BB6	EFC30X-3BB6
	Mech. interlock	EFC301-3MB6	EFC303-3MB6	EFC304-3MB6	EFC30X-3MB6
60	4 Pole ^①	EFJ601-4PB6	EFJ603-4PB6	EFJ604-4PB6	EFJ60X-4PB6
	6 Pole	EFJ601-6PB4	EFJ603-6PB4	EFJ604-6PB4	EFJ60X-6PB4
	Transfer	EFJ601-3TB8	EFJ603-3TB8	EFJ604-3TB8	EFJ60X-3TB8
	Mech. interlock	EFJ601-3MB6	EFJ603-3MB6	EFJ604-3MB6	EFJ60X-3MB6
100	2 Pole ^①	EFJ1001-2PB8	EFJ1003-2PB8	EFJ1004-2PB8	EFJ100X-2PB8
	4 Pole ^①	EFJ1001-4PB8	EFJ1003-4PB8	EFJ1004-4PB8	EFJ100X-4PB8
	6 Pole	EFJ1001-6PB4	EFJ1003-6PB4	EFJ1004-6PB4	EFJ100X-6PB4
	Transfer	EFJ1001-3TB8	EFJ1003-3TB8	EFJ1004-3TB8	EFJ100X-3TB8
	Mech. interlock	EFJ1001-3MB8	EFJ1003-3MB8	EFJ1004-3MB8	EFJ100X-3MB8
200	2 Pole ^①	EFJ2001-2PB8	EFJ2003-2PB8	EFJ2004-2PB8	EFJ200X-2PB8
	4 Pole ^①	EFJ2001-4PB4	EFJ2003-4PB4	EFJ2004-4PB4	EFJ200X-4PB4
	6 Pole	EFJ2001-6P8	EFJ2003-6P8	EFJ2004-6P8	EFJ200X-6P8
	Transfer	EFJ2001-3TB4	EFJ2003-3TB4	EFJ2004-3TB4	EFJ200X-3TB4
	Mech. interlock	EFJ2001-3MB4	EFJ2003-3MB4	EFJ2004-3MB4	EFJ200X-3MB4
400	2 Pole ^①	EFJ4001-2PB4	EFJ4003-2PB4	EFJ4004-2PB4	EFJ400X-2PB4
	4 Pole ^①	EFJ4001-4PB4	EFJ4003-4PB4	EFJ4004-4PB4	EFJ400X-4PB4
	6 Pole	EFJ4001-6P8	EFJ4003-6P8	EFJ4004-6P8	EFJ400X-6P8
	Transfer	EFJ4001-3TB4	EFJ4003-3TB4	EFJ4004-3TB4	EFJ400X-3TB4
	Mech. interlock	EFJ4001-3MB4	EFJ4003-3MB4	EFJ4004-3MB4	EFJ400X-3MB4
600	2 Pole ^①	EFJ6001-2PB4	EFJ6003-2PB4	EFJ6004-2PB4	EFJ600X-2PB4
	4 Pole ^①	EFJ6001-4PB4	EFJ6003-4PB4	EFJ6004-4PB4	EFJ600X-4PB4
	6 Pole	EFJ6001-6P8	EFJ6003-6P8	EFJ6004-6P8	EFJ600X-6P8
	Transfer	EFJ6001-3TB4	EFJ6003-3TB4	EFJ6004-3TB4	EFJ600X-3TB4
	Mech. interlock	EFJ6001-3MB4	EFJ6003-3MB4	EFJ6004-3MB4	EFJ600X-3MB4
800	2 Pole ^①	EFL8001-2PB4	EFL8003-2PB4	EFL8004-2PB4	EFL800X-2PB4
	4 Pole ^①	EFL8001-4PB4	EFL8003-4PB4	EFL8004-4PB4	EFL800X-4PB4
	6 Pole	EFL8001-6P8	EFL8003-6P8	EFL8004-6P8	EFL800X-6P8
	Transfer	EFL8001-3TB4	EFL8003-3TB4	EFL8004-3TB4	EFL800X-3TB4
	Mech. interlock	EFL8001-3MB4	EFL8003-3MB4	EFL8004-3MB4	EFL800X-3MB4

2 Pole



4 Pole

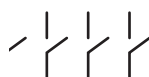

6 Pole

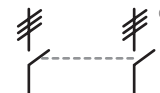

① IEC rated only.
② = Three poles

Fusible

Non-Fused

Enclosed Fused

Enclosed Non-Fused

for Enclosed Fusible Disconnect Switches
30A – 800A

NEMA Enclosure type

UL General purpose amp rating	Type of Switch	NEMA Enclosure type		
		4X Plastic Catalog number	12 Catalog number	7 & 9 Catalog number
30 (J fuses)	4 Pole ^①	EFJ30P-4PB6	EFJ302-4PB6	②
	6 Pole	EFJ30P-6PB6	EFJ302-6PB6	
	Transfer	EFJ30P-3TB8	EFJ302-3TB8	
	Bypass	EFJ30P-3BB6	EFJ302-3BB6	
	Mech. interlock	EFJ30P-3MB6	EFJ302-3MB6	
30 (CC fuses)	4 Pole ^①	EFC30P-4PB6	EFC302-4PB6	②
	6 Pole	EFC30P-6PB6	EFC302-6PB6	
	Transfer	EFC30P-3TB8	EFC302-3TB8	
	Bypass	EFC30P-3BB6	EFC302-3BB6	
	Mech. interlock	EFC30P-3MB6	EFC302-3MB6	
60	4 Pole ^①	EFJ60P-4PB6	EFJ602-4PB6	②
	6 Pole	EFJ60P-6PB4	EFJ602-6PB4	
	Transfer	EFJ60P-3TB8	EFJ602-3TB8	
	Mech. interlock	EFJ60P-3MB6	EFJ602-3MB6	
100	2 Pole ^①	EFJ100P-2PB8	EFJ1002-2PB8	②
	4 Pole ^①	EFJ100P-4PB8	EFJ1002-4PB8	
	6 Pole	EFJ100P-6PB4	EFJ1002-6PB4	
	Transfer	EFJ100P-3TB8	EFJ1002-3TB8	
	Mech. interlock	EFJ100P-3MB8	EFJ1002-3MB8	
200	2 Pole ^①	EFJ200P-2PB8	EFJ2002-2PB8	②
	4 Pole ^①	EFJ200P-4PB4	EFJ2002-4PB4	
	6 Pole	EFJ200P-6P8	EFJ2002-6P8	
	Transfer	EFJ200P-3TB4	EFJ2002-3TB4	
	Bypass	EFJ200P-3B6	EFJ2002-3B6	
400	2 Pole ^①	EFJ400P-2PB4	EFJ4002-2PB4	②
	4 Pole ^①	EFJ400P-4PB4	EFJ4002-4PB4	
	6 Pole	EFJ400P-6P8	EFJ4002-6P8	
	Transfer	EFJ400P-3TB4	EFJ4002-3TB4	
	Bypass	EFJ400P-3B6	EFJ4002-3B6	
600	2 Pole ^①	EFJ600P-2PB4	EFJ6002-2PB4	②
	4 Pole ^①	EFJ600P-4PB4	EFJ6002-4PB4	
	6 Pole	EFJ600P-6P8	EFJ6002-6P8	
	Transfer	EFJ600P-3TB4	EFJ6002-3TB4	
	Bypass	EFJ600P-3B6	EFJ6002-3B6	
800	2 Pole ^①	EFL800P-2PB4	EFL8002-2PB4	②
	4 Pole ^①	EFL800P-4PB4	EFL8002-4PB4	
	6 Pole	EFL800P-6P8	EFL8002-6P8	
	Transfer	EFL800P-3TB4	EFL8002-3TB4	
	Bypass	EFL800P-3B6	EFL8002-3B6	
800	Mech. interlock	EFL800P-3MB4	EFL8002-3MB4	

Transfer

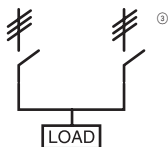

Bypass

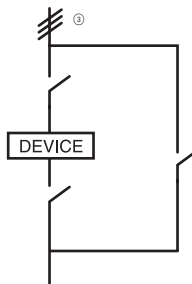

Mechanical interlock

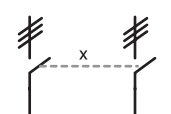

① IEC rated only.
② Consult factory for pricing and availability.
③ ≡ = Three poles

for Enclosed Fusible Disconnect Switches



BDAUX157

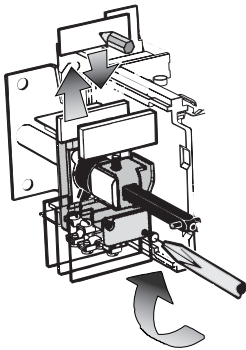

BDAUX7
BDAUX8

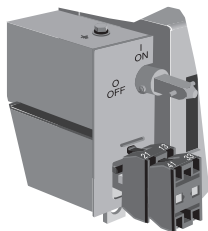

BDAUX1
BDAUX2



3 Position selection switch



Pilot light

Auxiliary contacts

For use on:	Contact configuration	Catalog number	Installation suffix
30A	1 N.O. + 1 N. C. 2 N.O. + 2 N.C.	BDAUX157	add "11" suffix add "22" suffix
60A – 100A	1 N.O. + 1 N.C. 2 N.O. + 2 N.C.	BDAUX7 BDAUX8	add "11" suffix add "22" suffix
200A – 3000A	1 N.O. & 1 N.C. 2 N.O. & 2 N.C.	BDAUX1 BDAUX12	add "11" suffix add "22" suffix

Accessories

For use on:	Description	Installation suffix
30A	Neutral block	N
60A – 100A	Neutral block	N
200A – 400A	Neutral block	N
600A – 800A	Neutral block	N
30A – 200A	Service entrance, 3 wire Service entrance, 4 wire	U V
400A – 800A	Service entrance, 3 wire Service entrance, 4 wire	U V
30A – 3000A	Start/stop pushbuttons 2 position selector switch 3 position selector switch Pilot light "red/run" Ammeter 1 phase Voltmeter	A C D E AM VM

Ground lugs

All enclosed switches are provided with a standard integral ground lug.

Switch size	Ground lug wire size
30	(2) # 14
60	#14 – 1/0
100 – 400	#6 – 250
600 – 800	#2 – 600 mcm

Fusible

Non-Fused

Enclosed Fused

Enclosed Non-Fused

Other Configuration Descriptions for Enclosed Disconnect Switches

Conversion mechanisms

6 or 8 pole

6 (8) pole mechanism allows two switches controlled by one handle to open or close simultaneously.

	POS. O	POS. I
SW. A	O	X
SW. B	O	X

X = Closed
O = Open

Transfer^①

Transfer mechanism manually transfers between two power sources using two switches and a center "OFF" position.

	POS. I	POS.O	POS.II
SW. A	X	O	O
SW. B	O	O	X

X = Closed
O = Open

Bypass^①

Bypass mechanism operates three switches: Two switches in series and one changeover switch to allow power bypass.

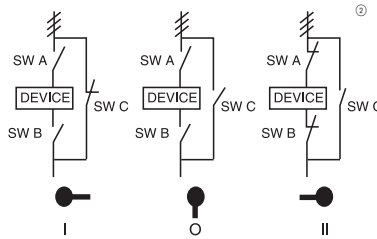

	POS. I	POS.O	POS.II
SW. A	O	O	X
SW. B	O	O	X
SW. C	X	O	O

X = Closed
O = Open

Mechanical interlock

Mechanical interlock mechanism prevents both switches from being in the ON position at the same time.

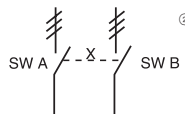

	SW. A POS. I	SW. B POS. O
SW. A	X	O
SW. B	O	X

X = Closed
O = Open

① Transfer and bypass enclosed switches include the load side bussed or cabled together, and all switches come standard with ground lugs.

② = Three poles

for 2, 3 & 4 Pole Enclosed Non-Fusible Switches
16A - 100A

Type 1 — 2, 3 & 4 Pole non-fusible switches

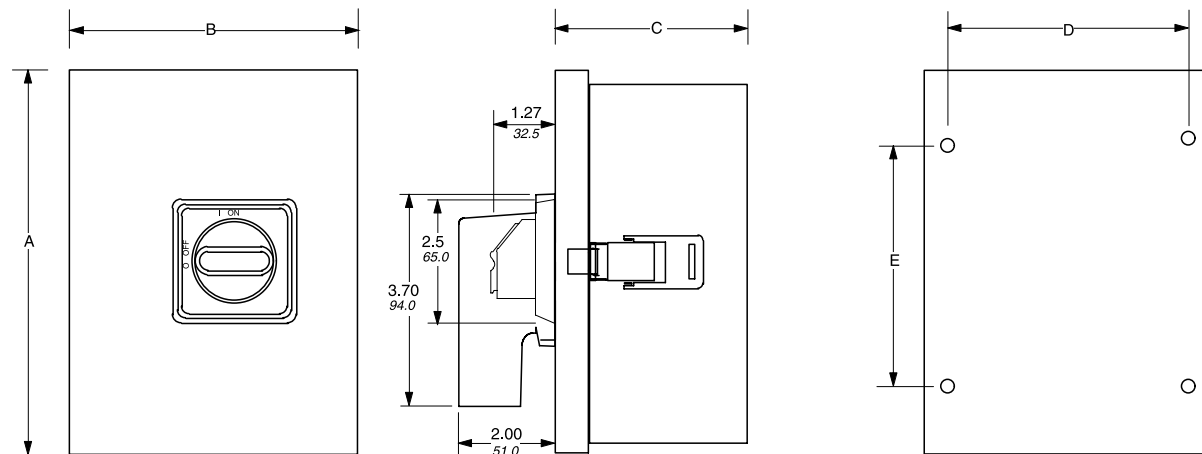

Amps		A	B	C	D	E	Weight 3 pole (lbs)
16A - 40A	in mm	6.00 152.0	6.00 152.0	4.00 102.0	5.00 127.0	3.00 76.0	4.10
60A - 80A	in mm	8.00 203.0	6.00 152.0	4.00 102.0	5.00 127.0	5.00 127.0	5.60
30, 60, 100A	in mm	10.00 254.0	8.00 203.0	6.00 152.0	7.00 179.0	7.00 179.0	9.00

Type 3R, 4, 4X Stainless, 12 — 2, 3 & 4 Pole non-fusible switches

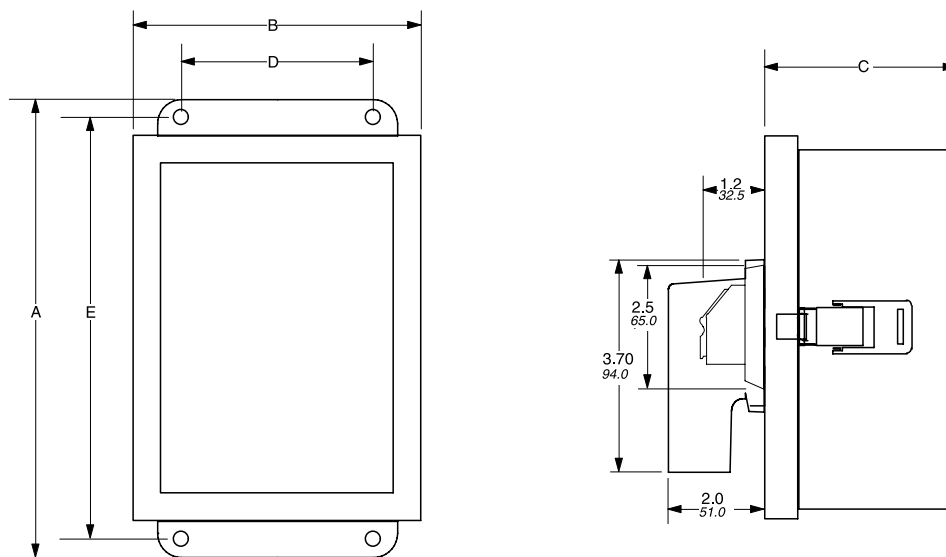

Amps		A	B	C	D	E	Weight 3 pole (lbs)
16A - 40A	in mm	7.50 190.0	6.00 152.0	4.00 102.0	4.00 127.0	6.75 171.0	6.50
60A - 80A	in mm	9.50 241.0	6.00 152.0	4.00 102.0	5.00 127.0	8.75 222.0	8.30
30, 60, 100A	in mm	11.50 292.0	8.00 203.0	6.00 152.0	7.00 179.0	10.75 273.0	12.00

Fusible

Non-Fused

Enclosed Fused

Enclosed Non-Fused

for 2, 3 & 4 Pole Enclosed Non-Fusible & Fusible Switches
16A – 3150A NF; 30A – 800A F

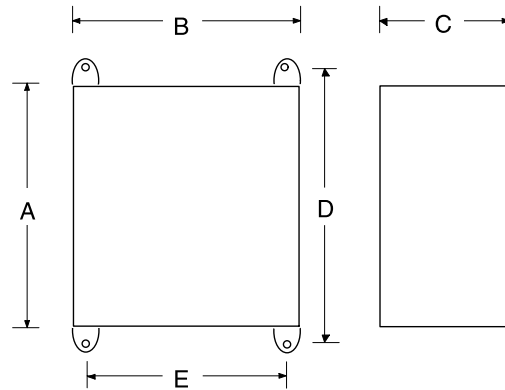

Fusible

Non-Fused

Enclosed Fused

Enclosed Non-Fused

Non-fusible switches

Amp rating	Enclosure type	A Height	B Width	C Depth ^①	D Mounting	E Mounting	Weight (3 Pole)
16 – 40	4X Plastic	6.00	6.00	5.00	2.00	6.75	4.52
60 – 80	4X Plastic	8.00	6.00	5.00	4.00	8.75	5.36
30, 60, 100A	4X Plastic	10.00	8.00	7.00	6.00	10.75	9.03
16 – 30 (A)*	IP65 Plastic	4.72	3.35	2.36	4.17	2.80	0.92
16 – 30 (B)	IP65 Plastic	5.91	5.12	2.36	5.35	4.57	1.16
40 – 60	IP65 Plastic	7.87	5.71	3.54	7.24	5.16	1.85
80 – 100 (A)*	IP65 Plastic	7.87	5.71	3.54	7.24	5.16	2.06
80 – 100 (B)	IP65 Plastic	15.75	7.87	5.51	14.8	6.93	7.25
125	IP65 Plastic	15.75	7.87	5.51	14.8	6.93	7.25
200	1	24.00	20.00	8.62	15.00	21.88	51.03
	3R	24.00	20.00	8.00	13.00	25.00	62.58
	4	24.00	20.00	8.00	18.50	22.50	54.18
	4X SS	24.00	20.00	8.00	18.50	22.50	55.23
	4X Plastic	24.00	16.00	9.80			33.71
400	1	36.00	30.00	12.62	22.75	33.50	129.89
	3R	36.00	30.00	12.00	28.50	34.50	141.44
	4	36.00	30.00	12.00	28.50	34.50	141.44
	4X SS	36.00	30.00	12.00	28.50	34.50	141.44
	4X Plastic	40.00	20.00	12.00	18.18	42.01	86.31
600	1	36.00	30.00	12.62	22.75	33.50	129.89
	3R	36.00	30.00	12.00	28.50	34.50	141.44
	4	36.00	30.00	12.00	28.50	34.50	141.44
	4X SS	36.00	30.00	12.00	28.50	34.50	141.44
	4X Plastic	40.00	20.00	12.00	18.18	51.85	86.31
800	1	48.00	36.00	13.25	28.75	45.87	237.20
	3R	48.00	36.00	12.00	34.50	46.50	229.85
	4	48.00	36.00	12.00	34.50	46.50	229.85
	4X SS	48.00	36.00	12.00	34.50	46.50	235.10
	4X Plastic	50.00	20.00	12.00	30.00	61.41	124.85
1200	1	48.00	36.00	13.25	28.75	45.87	239.93
	3R	48.00	36.00	12.00	34.50	46.50	232.58
	4	48.00	36.00	12.00	34.50	46.50	232.58
	4X SS	48.00	36.00	12.00	34.50	46.50	237.83
	4X Plastic	50.00	20.00	12.00	30.00	61.41	127.58
1600-3150				Consult factory			

* 3 Pole switches only

Fusible switches

Amp rating	Enclosure type	A Height	B Width	C Depth ^①	D Mounting	E Mounting	Weight (3 Pole)
30	1	10.00	8.00	6.00	7.00	7.00	11.07
	3R	10.00	8.00	6.00	6.00	10.75	13.17
	4	10.00	8.00	6.00	6.00	10.75	13.17
	4X SS	10.00	8.00	6.00	6.00	10.75	13.17
	4X Plastic	10.00	8.00	7.00	6.00	10.75	8.13
60	12	10.00	8.00	6.00	6.00	10.75	13.17
	1	10.00	8.00	6.00	7.00	7.00	13.15
	3R	10.00	8.00	6.00	6.00	10.75	15.25
	4	10.00	8.00	6.00	6.00	10.75	15.25
	4X SS	10.00	8.00	6.00	6.00	10.75	15.25
100	4X Plastic	10.00	8.00	7.00	6.00	10.75	10.21
	12	10.00	8.00	6.00	6.00	10.75	15.25
	1	14.00	12.00	8.00	11.00	11.00	22.58
	3R	14.00	12.00	8.00			22.58
	4	16.00	12.00	8.00	10.50	14.50	24.57
200	4X SS	16.00	12.00	8.00	10.50	14.50	24.57
	4X Plastic	14.00	12.00	7.00	10.00	14.94	15.54
	12	14.00	12.00	8.00	10.00	14.75	26.78
	1	24.00	24.00 ^②	12.62	19.00	21.88	85.26
	3R ^②	24.00	20.00	12.00	18.50	22.50	69.51
400	4	24.00	20.00	12.00	18.50	22.50	69.51
	4X SS	24.00	24.00 ^②	12.00	22.50	22.50	78.96
	4X Plastic	24.00	16.00	9.80	18.18	32.16	42.74
	12	24.00	20.00	12.00	18.50	22.50	69.51
	1	36.00	30.00	12.62	22.75	33.50	133.56
600	3R ^②	36.00	30.00	12.00	28.50	34.50	145.11
	4	36.00	30.00	12.00	28.50	34.50	145.11
	4X SS	36.00	30.00	12.00	28.50	34.50	145.11
	4X Plastic	40.00	20.00	12.00	28.02	42.01	89.99
	12	36.00	30.00	12.00	28.50	34.50	145.11
800	1	48.00	36.00	13.25	28.75	45.87	238.88
	3R ^②	48.00	36.00	12.00	34.50	46.50	231.53
	4	48.00	36.00	12.00	34.50	46.50	231.53
	4X SS	48.00	36.00	12.00	34.50	46.50	236.78
	4X Plastic	50.00	20.00	12.00	28.02	51.85	126.53
1200	12	48.00	36.00	12.00	34.50	46.50	231.53
	1	48.00	36.00	17.25	28.75	45.87	255.68
	3R ^②	48.00	36.00	16.00	34.50	46.50	247.28
	4	48.00	36.00	16.00	34.50	46.50	247.28
	4X SS	48.00	36.00	16.00	30.00	49.25	254.63
800	4X Plastic	50.00	20.00	12.00	37.87	51.85	126.53
	12	48.00	36.00	16.00	34.50	46.50	247.28

All dimensions are in inches.

① Enclosure depth only. Handle is not included.
② Uses a type 4 enclosure, less cost.

for 6 Pole, Enclosed Transfer & Mechanical Interlock
16A – 3150A NF; 30A – 800A F

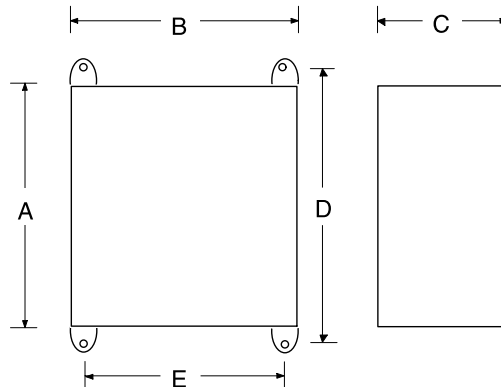

6 Pole, transfer & mechanical interlock
non-fusible switches

Amp	Enclosure rating	A type	B Height	C Width	D Depth ^①	E Mounting	Weight Mounting
16 – 30	IP65 Plastic	5.91	5.12	3.35	5.35	4.57	3.40
16 – 60	1	10.00	8.00	6.00	7.00	7.00	11.55
	3R	10.00	8.00	6.00	6.00	10.75	13.65
	4	10.00	8.00	6.00	6.00	10.75	13.65
	4X SS	10.00	8.00	6.00	6.00	10.75	13.65
	4X Plastic	10.00	8.00	7.00	6.00	10.75	4.20
80 – 125	12	10.00	8.00	6.00	6.00	10.75	13.65
	1	14.00	12.00	8.00	11.00	11.00	23.63
	3R	14.00	12.00	8.00	8.00	23.63	
	4	16.00	12.00	8.00	10.50	14.50	25.62
	4X SS	16.00	12.00	8.00	10.50	14.50	25.62
200	4X Plastic	14.00	12.00	7.00	10.00	14.94	8.93
	12	14.00	12.00	8.00	10.00	14.75	27.83
	1	30.00	24.00	12.62	22.75	33.50	100.80
	3R	30.00	24.00	12.00	22.50	28.50	93.45
	4	30.00	24.00	12.00	22.50	28.50	93.45
400	4X SS	30.00	24.00	12.00	22.50	28.50	93.45
	4X Plastic	30.00	20.00	12.00	18.18	32.16	53.45
	12	30.00	24.00	12.00	22.50	28.50	93.45
	1	36.00	30.00	12.62	22.75	33.50	144.90
	3R	36.00	30.00	12.00	28.50	34.50	156.45
600	4	36.00	30.00	12.00	28.50	34.50	156.45
	4X SS	36.00	30.00	12.00	28.50	34.50	156.45
	4X Plastic	40.00	20.00	12.00	18.18	42.01	101.33
	12	36.00	36.00	12.00	28.50	34.50	156.45
	1	48.00	36.00	13.25	28.75	45.87	228.90
800	3R	48.00	36.00	12.00	34.50	46.50	221.55
	4	48.00	36.00	12.00	34.50	46.50	221.55
	4X SS	48.00	36.00	12.00	34.50	46.50	226.80
	4X Plastic	50.00	20.00	12.00	18.18	51.85	116.55
	12	48.00	36.00	12.00	34.50	46.50	221.55
1600	1	60.00	36.00	20.00	30.00	61.25	354.90
	3R	72.00	31.00	24.00	F.S.	F.S.	502.95
	4	72.00	31.00	24.00	F.S.	F.S.	502.95
	4X SS	72.00	31.00	24.00	F.S.	F.S.	502.95
	4X Plastic	72.00	25.00	24.50	F.S.	F.S.	348.60
12	60.00	36.00	20.00	30.00	61.25	354.90	

6 Pole, transfer & mechanical interlock
fusible switches

Amp rating	Enclosure type	A Height	B Width	C Depth ^①	D Mounting	E Mounting	Weight
30	1	14.00	12.00	8.00	11.00	11.00	22.58
	3R	14.00	12.00	8.00			22.58
	4	16.00	12.00	8.00	10.50	14.50	24.57
	4X SS	16.00	12.00	8.00	10.50	14.50	24.57
	4X Plastic	14.00	12.00	7.00	10.00	14.94	15.54
60	12	14.00	12.00	8.00	10.00	14.75	26.78
	1	24.00	24.00	12.62	19.00	21.88	76.65
	3R	24.00	20.00	12.00	18.50	22.50	60.90
	4	24.00	20.00	12.00	18.50	22.50	60.90
	4X SS	24.00	24.00	12.00	22.50	22.50	70.35
100	4X Plastic	24.00	16.00	9.80	18.18	32.16	34.13
	12	24.00	20.00	12.00	18.50	22.50	60.90
	1	30.00	24.00	12.62	22.75	33.50	94.50
	3R	30.00	24.00	12.00	22.50	28.50	87.15
	4	30.00	24.00	12.00	22.50	28.50	87.15
200	4X SS	30.00	24.00	12.00	22.50	28.50	87.15
	4X Plastic	30.00	20.00	12.00	18.18	32.16	47.15
	12	30.00	24.00	12.00	22.50	28.50	87.15
	1	36.00	30.00	12.62	22.75	33.50	148.05
	3R	36.00	30.00	12.00	28.50	34.50	159.60
400	4	36.00	30.00	12.00	28.50	34.50	159.60
	4X SS	36.00	30.00	12.00	28.50	34.50	159.60
	4X Plastic	40.00	20.00	12.00	18.18	42.01	104.48
	12	36.00	30.00	12.00	28.50	34.50	159.60
	1	36.00	30.00	12.62	22.75	33.50	152.25
600	3R	36.00	30.00	12.00	28.50	34.50	163.80
	4	36.00	30.00	12.00	28.50	34.50	163.80
	4X SS	36.00	30.00	12.00	28.50	34.50	163.80
	4X Plastic	40.00	20.00	12.00	18.18	42.01	108.68
	12	36.00	30.00	12.00	28.50	34.50	163.80
800	1	48.00	36.00	17.25	28.75	45.87	295.05
	3R	48.00	36.00	16.00	34.50	46.50	286.65
	4	48.00	36.00	16.00	34.50	46.50	286.65
	4X SS	48.00	36.00	16.00	30.00	49.25	294.00
	4X Plastic	48.25	36.25	16.00	30.00	49.60	222.60
1600	12	48.00	36.00	16.00	34.50	46.50	286.65
	1	48.00	36.00	17.25	28.75	45.87	295.05
	3R	48.00	36.00	16.00	34.50	46.50	286.65
	4	48.00	36.00	16.00	34.50	46.50	286.65
	4X SS	48.00	36.00	16.00	30.00	49.25	294.00
3150	4X Plastic	48.25	36.25	16.00	30.00	49.60	222.60
	12	48.00	36.00	16.00	34.50	46.50	286.65

All dimensions are in inches.

① Enclosure depth only. Handle is not included.

for Enclosed Bypass Mechanisms

16A - 3150A NF, 30A - 800A F

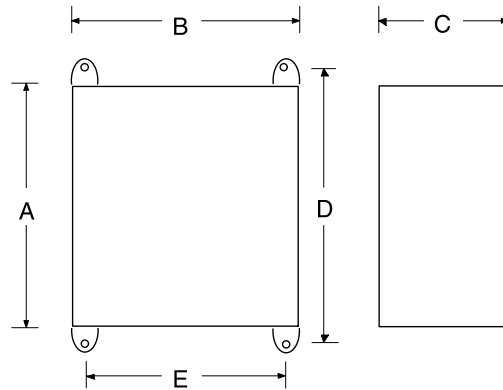

Fusible

Non-Fused

Enclosed Fused

Enclosed Non-Fused

Bypass mechanism for non-fusible switches

Amp rating	Enclosure type	A Height	B Width	C Depth ^①	D Mounting	E Mounting	Weight
16 - 60	1	10.00	8.00	6.00	7.00	7.00	11.55
	3R	10.00	8.00	6.00	6.00	10.75	13.65
	4	10.00	8.00	6.00	6.00	10.75	13.65
	4X SS	10.00	8.00	6.00	6.00	10.75	13.65
	4X Plastic	10.00	8.00	7.00	6.00	10.75	8.61
12	10.00	8.00	6.00	6.00	10.75	13.65	
80 - 125	1	14.00	12.00	8.00	11.00	11.00	23.63
	3R	14.00	12.00	8.00	10.50	14.50	25.62
	4	16.00	12.00	8.00	10.50	14.50	25.62
	4X SS	16.00	12.00	8.00	10.50	14.50	25.62
	4X Plastic	14.00	12.00	7.00	10.00	14.75	27.83
12	14.00	12.00	8.00	10.00	14.75	27.83	
200	1	36.00	30.00	12.62	22.75	33.50	144.90
	3R	36.00	30.00	12.00	28.50	34.50	156.45
	4	36.00	30.00	12.00	28.50	34.50	156.45
	4X SS	36.00	30.00	12.00	28.50	34.50	156.45
	4X Plastic	40.00	20.00	12.00	28.50	34.50	101.33
12	36.00	30.00	12.00	28.50	34.50	156.45	
400	1	36.00	30.00	12.62	22.75	33.50	144.90
	3R	36.00	30.00	12.00	28.50	34.50	156.45
	4	36.00	30.00	12.00	28.50	34.50	156.45
	4X SS	36.00	30.00	12.00	28.50	34.50	156.45
	4X Plastic	40.00	20.00	12.00	28.50	34.50	101.33
12	36.00	30.00	12.00	28.50	34.50	156.45	
600	1	60.00	36.00	20.00	30.00	61.25	354.90
	3R	72.00	31.00	24.00	F.S.	F.S.	502.95
	4	72.00	31.00	24.00	F.S.	F.S.	502.95
	4X SS	72.00	31.00	24.00	F.S.	F.S.	502.95
	4X Plastic	72.00	25.00	24.50	F.S.	F.S.	348.60
12	60.00	36.00	20.00	30.00	61.25	354.90	
800	1	60.00	36.00	20.00	30.00	61.25	354.90
	3R	72.00	31.00	24.00	F.S.	F.S.	502.95
	4	72.00	31.00	24.00	F.S.	F.S.	502.95
	4X SS	72.00	31.00	24.00	F.S.	F.S.	502.95
	4X Plastic	72.00	25.00	24.50	F.S.	F.S.	347.60
12	60.00	36.00	20.00	30.00	61.25	354.90	

Bypass mechanism for fusible switches

Amp rating	Enclosure type	A Height	B Width	C Depth ^①	D Mounting	E	Weight
30	1	24.00	24.00 ^②	12.62	19.00	21.88	77.70
	3R	24.00	20.00	12.00	18.50	22.50	61.95
	4	24.00	20.00	12.00	18.50	22.50	61.95
	4X SS	24.00	24.00 ^②	12.00	22.50	22.50	71.40
	4X Plastic	24.00	16.00	9.80	18.50	22.50	35.18
12	24.00	20.00	12.00	18.50	22.50	61.95	
60	1	24.00	24.00 ^②	12.62	19.00	21.88	81.90
	3R ^②	24.00	20.00	12.00	18.50	22.50	66.15
	4	24.00	20.00	12.00	18.50	22.50	66.15
	4X SS	24.00	24.00 ^②	12.00	22.50	22.50	76.50
	4X Plastic	24.00	16.00	9.80	18.50	22.50	39.38
12	24.00	20.00	12.00	18.50	22.50	66.15	
100	1	30.00	24.00	12.62	22.75	33.50	102.90
	3R ^②	30.00	24.00	12.00	22.50	28.50	95.55
	4	30.00	24.00	12.00	22.50	28.50	95.55
	4X SS	30.00	24.00	12.00	22.50	28.50	95.55
	4X Plastic	30.00	20.00	12.00	22.50	28.50	55.55
12	30.00	24.00	12.00	22.50	28.50	95.55	
200	1	36.00	30.00	12.62	22.75	33.50	169.05
	3R ^②	36.00	30.00	12.00	28.50	34.50	180.60
	4	36.00	30.00	12.00	28.50	34.50	180.60
	4X SS	36.00	30.00	12.00	28.50	34.50	180.60
	4X Plastic	40.00	20.00	12.00	28.50	34.50	125.48
12	36.00	30.00	12.00	28.50	34.50	180.60	
400	1	36.00	30.00	12.62	22.75	33.50	173.25
	3R ^②	36.00	30.00	12.00	28.50	34.50	184.80
	4	36.00	30.00	12.00	28.50	34.50	184.80
	4X SS	36.00	30.00	12.00	28.50	34.50	184.80
	4X Plastic	40.00	20.00	12.00	28.50	34.50	129.68
12	36.00	30.00	12.00	28.50	34.50	184.80	
600	1	48.00	36.00	17.25	28.75	45.87	337.05
	3R ^②	48.00	36.00	16.00	34.50	46.50	328.65
	4	48.00	36.00	16.00	34.50	46.50	328.65
	4X SS	48.00	36.00	16.00	30.00	49.25	336.00
	4X Plastic	48.25	36.25	16.00	30.00	49.60	264.60
12	48.00	36.00	16.00	34.50	46.50	328.65	
800	1	48.00	36.00	17.25	28.75	45.87	337.05
	3R ^②	48.00	36.00	16.00	34.50	46.50	328.65
	4	48.00	36.00	16.00	34.50	46.50	328.65
	4X SS	48.00	36.00	16.00	30.00	49.25	336.00
	4X Plastic	48.25	36.25	16.00	30.00	49.60	264.60
12	48.00	36.00	16.00	34.50	46.50	328.65	

① Enclosure depth only. Handle is not included.
 ② Uses a type 4 enclosure, less cost.