

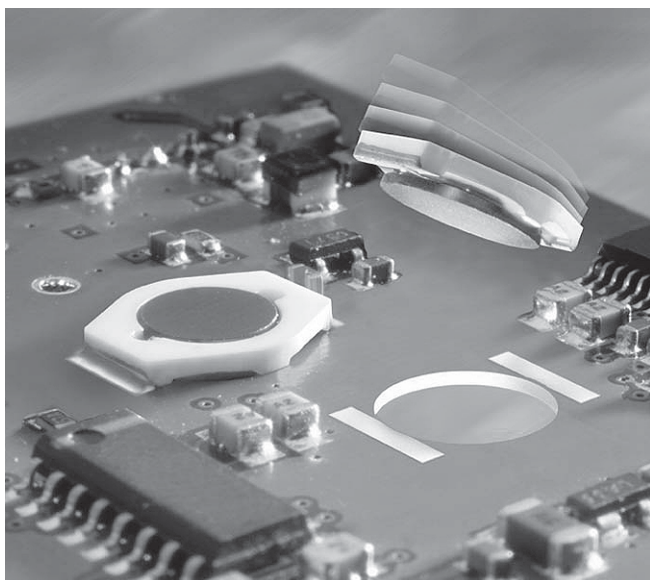

SMT Power Inductors - LPO2506 Series



With an above-board height of just 1,19 mm, this is our thinnest power inductor series, perfect for PC Card or other low profile applications.

The LPO2506 comes in two styles. One is a standard on-board design that is 1,65 mm high. The second uses Coilcraft's InBoard® Technology. By dropping the inductor core through a hole in the circuit board, the above-board height is reduced to 1,19 mm. (Custom designs can reduce this even further to a maximum of 0,9 mm, depending on board thickness.)

Coilcraft **Designer's Kit C332** contains samples of all in-board values shown; **Kit C333** contains all on-board values. To order, contact Coilcraft, or purchase them online at <http://order.coilcraft.com>.



SPICE models ON OUR WEB SITE OR CD

In-board style part number ¹	On-board style part number ¹	L ±20% ² (µH)	DCR max (Ohms)	SRF typ (MHz)	Isat ³ (A)	Irms ⁴ (A)
LPO2506I-472L_	LPO2506O-472L_	4.7	0.145	90	1.6	1.9
LPO2506I-682L_	LPO2506O-682L_	6.8	0.165	75	1.3	1.7
LPO2506I-822L_	LPO2506O-822L_	8.2	0.200	65	1.0	1.5
LPO2506I-103L_	LPO2506O-103L_	10	0.240	60	1.0	1.5
LPO2506I-153L_	LPO2506O-153L_	15	0.300	45	0.90	1.3
LPO2506I-223L_	LPO2506O-223L_	22	0.420	35	0.70	1.0
LPO2506I-333L_	LPO2506O-333L_	33	0.550	30	0.60	0.90
LPO2506I-473L_	LPO2506O-473L_	47	0.765	22	0.50	0.70
LPO2506I-683L_	LPO2506O-683L_	68	1.10	20	0.40	0.60
LPO2506I-104L_	LPO2506O-104L_	100	1.60	15	0.30	0.50
LPO2506I-154L_	LPO2506O-154L_	150	2.50	12	0.25	0.40
LPO2506I-224L_	LPO2506O-224L_	220	3.65	10	0.22	0.32
LPO2506I-334L_	LPO2506O-334L_	330	4.65	8.0	0.18	0.28
LPO2506I-474L_	LPO2506O-474L_	470	6.75	6.5	0.14	0.24
LPO2506I-684L_	LPO2506O-684L_	680	9.15	5.5	0.12	0.20
LPO2506I-105L_	LPO2506O-105L_	1000	14.20	4.5	0.10	0.16

1. When ordering, please specify **packaging** code:

LPO2506I-105L **D**

Packaging: **D** = 13" machine-ready reel. EIA-481 embossed plastic tape (1000 parts per full reel).

B = Less than full reel. In tape, but not machine ready.

To have a leader and trailer added (\$25 charge), use code letter D instead.

2. Tested at 100 kHz, 0.1 Vrms, 0 Adc.
3. DC current at which the inductance drops 10% (typ) from its value without current.
4. Average current for a 40°C rise above 25°C ambient.
5. Operating temperature range -40°C to +85°C.
6. Electrical specifications at 25°C.

Coilcraft®

Specifications subject to change without notice.
Please check our website for latest information.

Document 208-1 Revised 05/23/05

1102 Silver Lake Road Cary, Illinois 60013 Phone 847/639-6400 Fax 847/639-1469

E-mail info@coilcraft.com Web <http://www.coilcraft.com>



SMT Power Inductors - LPO2506 Series

Typical L vs Frequency

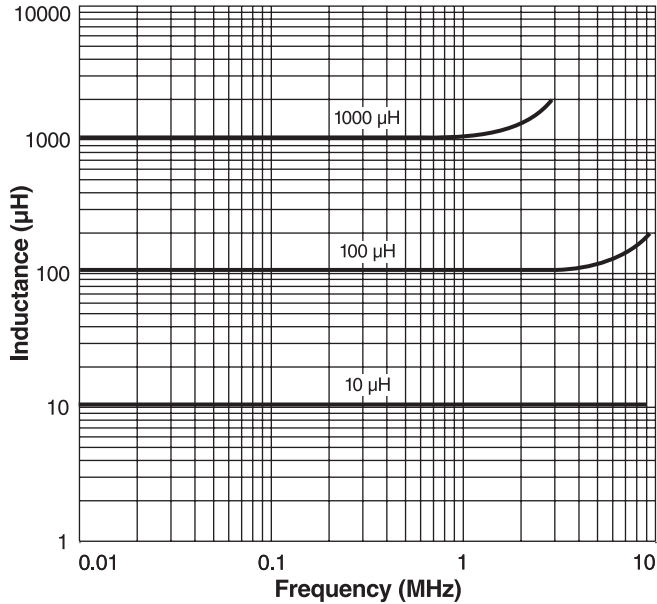

Typical L vs Current

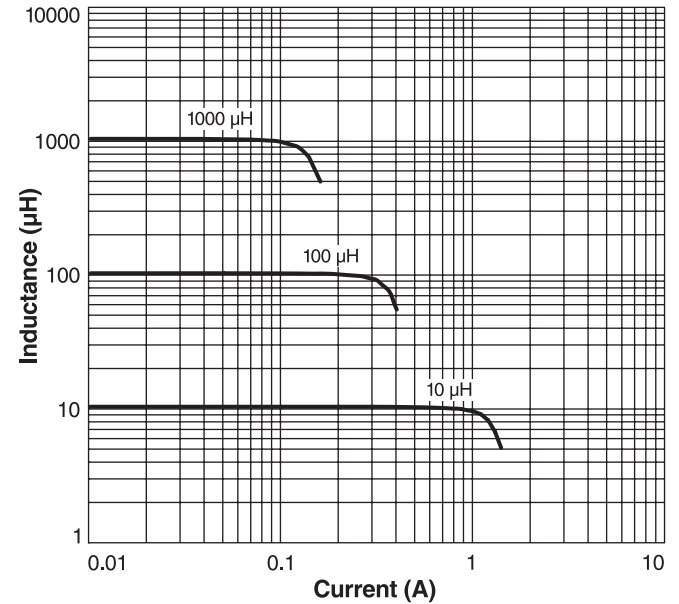

On-board Style

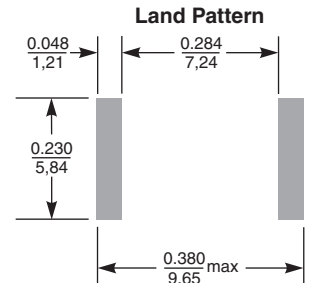
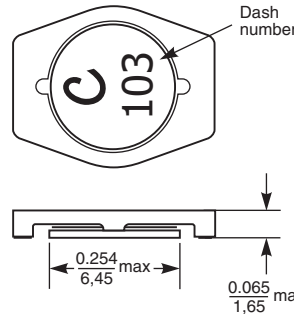
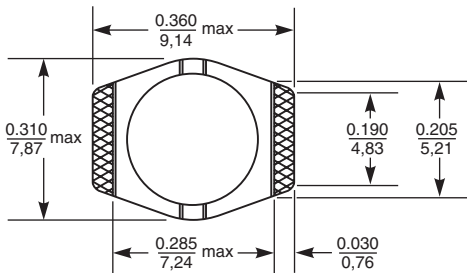

In-board Style

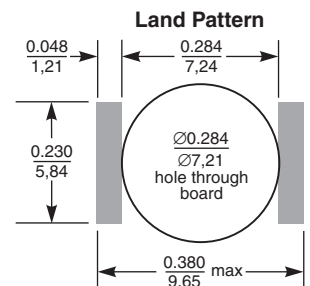
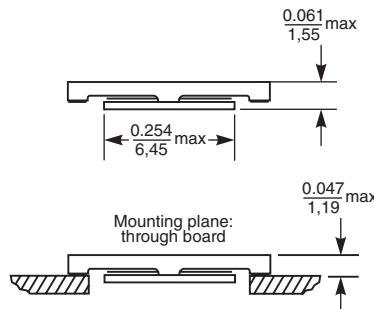
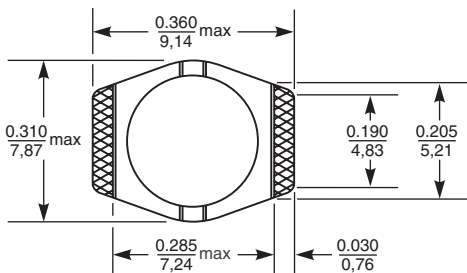

Terminations: Silver-palladium-platinum-glass frit
Weight: 0.24 – 0.26 g
Tape and reel: 1000/13" reel 16 mm tape width
 For packaging data see Tape and Reel Specifications section.



Specifications subject to change without notice.
 Please check our website for latest information.

Document 208-2 Revised 05/19/06