

ASSP Mobile Communication Systems

Piezoelectric SAW BPF (700 to 1700 MHz)

F5/F6 Series (S2 type) Soft SAW

■ DESCRIPTION

The S2 type of SAW bandpass filters are named "Soft SAW" because of their performance.

The S2 type filters have low insertion loss in passband and are housed in a small surface mount package. Moreover, the impedance in the passband is 50 ohms, and so applications require no external matching circuits.

The S2 type filters are suitable for interstage RF filter and L_o injection filter in mobile communication systems in the frequency range 700 to 1700 MHz. Standard devices are available for AMPS, GSM, PDC800 and PDC1.5G.

■ FEATURES

- Low insertion loss
- High handling power (0.2 Watt)
- Ultra compact and light package (3.8 mm)
- External matching circuits are not required.
- Surface mount package (SMT)
- Wide variety of standard devices for worldwide mobile communication systems (AMPS, GSM, PDC800, DUAL BAND PDC800 and PDC1.5G)

■ PACKAGE

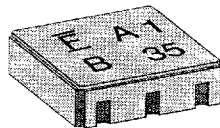

■ 3749756 0024858 913 ■

F5/F6 Series (S2) Soft SAW

■ PIN ASSIGNMENT

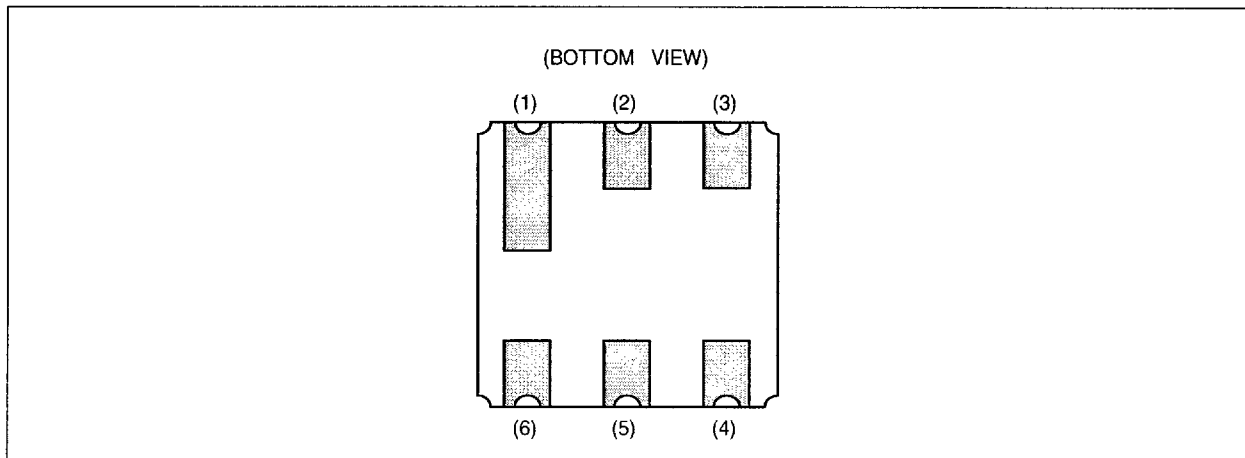

■ PIN DESCRIPTION

Pin No.	Pin name	Description
1	GND	Ground Pin
2	IN	Input Pin
3	GND	Ground Pin
4	GND	Ground Pin
5	OUT	Output Pin
6	GND	Ground Pin

F5/F6 Series (S2) Soft SAW

■ ABSOLUTE MAXIMUM RATINGS (See WARNING)

Parameter	Symbol	Rating	Unit
Operating temperature	T _a	-30 to +85	°C
Storage temperature	T _{stg}	-40 to +100	°C
Maximum input power	P _{IN}	200	mW
Frequency range	—	700 to 1700	MHz

WARNING: Permanent device damage may occur if the above **Absolute Maximum Ratings** are exceeded. Functional operation should be restricted to the conditions as detailed in the operational sections of this data sheet. Exposure to absolute maximum rating conditions for extended periods may affect device reliability.

■ RECOMMENDED OPERATING CONDITIONS

Parameter	Symbol	Value	Unit
Operating temperature	T _a	-30 to +85	°C

■ STANDARD FREQUENCIES

Center freq. (MHz)	BW (MHz)	System		Part Symbol	Part number
836.5	25	AMPS/ADC	Tx	A1	FAR-F5CH-836M50-S2A1
881.5	25		Rx	A2	FAR-F5CH-881M50-S2A2
902.5	25	NMT/GSM	Tx	E1	FAR-F5CH-902M50-S2E1
947.5	25		Rx	E2	FAR-F5CH-947M50-S2E2
948.0	16	PDC800	Tx	F1	FAR-F5CH-950M00-S2F1
818.0	16		Rx	F2	FAR-F5CH-820M00-S2F2
940.5	31	Dual Band PDC800	Tx	M1	FAR-F5CH-940M50-S2M1
1007.5	15		Lo	M3	FAR-F6CH-1G0075-S2M3
1441.0	24	PDC1.5G	Tx	Z1	FAR-F6CH-1G4410-S2Z1
1489.0	24		Rx	Z2	FAR-F6CH-1G4890-S2Z2
1359.0	24		Lo	Z3	FAR-F6CH-1G3590-S2Z3
1619.0	24			Z4	FAR-F6CH-1G6190-S2Z4

F5/F6 Series (S2) Soft SAW

■ ELECTRIC CHARACTERISTICS

1. AMPS/ADC (Tx) Part number: FAR-F5CH-836M50-S2A1

(T_a = -30 to +85°C)

Parameter	Symbol	Condition	Value			Unit	Remarks
			Min.	Typ.	Max.		
Insertion loss	IL	824 to 849 MHz	—	1.5	3.0	dB	
Inband ripple	—	824 to 849 MHz	—	0.5	2.0	dB	
Absolute attenuation	—	779 to 804 MHz	10	15	—	dB	
	—	869 to 894 MHz	15	18	—	dB	
Inband VSWR	—	824 to 849 MHz	—	2.0	2.5	—	

2. AMPS/ADC (Rx) Part number: FAR-F5CH-881M50-S2A2

(T_a = -30 to +85°C)

Parameter	Symbol	Condition	Value			Unit	Remarks
			Min.	Typ.	Max.		
Insertion loss	IL	869 to 894 MHz	—	2.0	3.5	dB	
Inband ripple	—	869 to 894 MHz	—	0.7	2.0	dB	
Absolute attenuation	—	824 to 849 MHz	15	18	—	dB	
	—	914 to 939 MHz	10	13	—	dB	
	—	959 to 984 MHz	25	28	—	dB	
Inband VSWR	—	869 to 894 MHz	—	2.0	2.5	—	

3. NMT/GSM (Tx) Part number: FAR-F5CH-902M50-S2E1

(T_a = -30 to +85°C)

Parameter	Symbol	Condition	Value			Unit	Remarks
			Min.	Typ.	Max.		
Insertion loss	IL	890 to 915 MHz	—	1.7	2.8	dB	
Inband ripple	—	890 to 915 MHz	—	0.5	2.0	dB	
Absolute attenuation	—	600 to 845 MHz	15	18	—	dB	
	—	935 to 960 MHz	20	23	—	dB	
	—	960 to 1240 MHz	15	18	—	dB	
Inband VSWR	—	890 to 915 MHz	—	1.8	2.5	—	

F5/F6 Series (S2) Soft SAW

4. NMT/GSM (Rx)

Part number: FAR-F5CH-947M50-S2E2

(T_a = -30 to +85°C)

Parameter	Symbol	Condition	Value			Unit	Remarks
			Min.	Typ.	Max.		
Insertion loss	IL	935 to 960 MHz	—	2.0	3.0	dB	
Inband ripple	—	935 to 960 MHz	—	0.5	2.0	dB	
Absolute attenuation	—	600 to 845 MHz	15	17	—	dB	
	—	890 to 915 MHz	17	20	—	dB	
	—	1005 to 1110 MHz	25	28	—	dB	
	—	1110 to 1240 MHz	40	23	—	dB	
Inband VSWR	—	935 to 960 MHz	—	2.0	2.5	—	

5. PDC800 (Tx)

Part number: FAR-F5CH-950M00-S2F1

(T_a = -30 to +85°C)

Parameter	Symbol	Condition	Value			Unit	Remarks
			Min.	Typ.	Max.		
Insertion loss	IL	940 to 956 MHz	—	1.7	2.2	dB	
Inband ripple	—	940 to 956 MHz	—	0.5	1.3	dB	
Absolute attenuation	—	810 to 826 MHz	20	23	—	dB	
Inband VSWR	—	940 to 956 MHz	—	1.2	2.0	—	

6. PDC800 (Rx)

Part number: FAR-F5CH-820M00-S2F2

(T_a = -30 to +85°C)

Parameter	Symbol	Condition	Value			Unit	Remarks
			Min.	Typ.	Max.		
Insertion loss	IL	810 to 826 MHz	—	1.4	2.2	dB	
Inband ripple	—	810 to 826 MHz	—	0.5	1.3	dB	
Absolute attenuation	—	940 to 956 MHz	25	28	—	dB	
	—	1070 to 1086 MHz	25	28	—	dB	
Inband VSWR	—	810 to 826 MHz	—	1.5	2.0	—	

F5/F6 Series (S2) Soft SAW

7. Dual Band PDC800 (Tx) Part number: FAR-F5CH-940M50-S2M1

(T_a = -30 to +85°C)

Parameter	Symbol	Condition	Value			Unit	Remarks
			Min.	Typ.	Max.		
Insertion loss	IL	925 to 956 MHz	—	2.3	2.8	dB	
Inband ripple	—	925 to 956 MHz	—	0.5	1.5	dB	
Absolute attenuation	—	810 to 826 MHz	18	20	—	dB	
	—	870 to 885 MHz	20	23	—	dB	
Inband VSWR	—	925 to 956 MHz	—	1.7	2.2	—	

8. Dual Band PDC800 (Lo) Part number: FAR-F6CH-1G0075-S2M3

(T_a = -30 to +85°C)

Parameter	Symbol	Condition	Value			Unit	Remarks
			Min.	Typ.	Max.		
Insertion loss	IL	1000 to 1015 MHz	—	2.0	2.5	dB	
Inband ripple	—	1000 to 1015 MHz	—	0.5	1.5	dB	
Absolute attenuation	—	795 to 940 MHz	20	23	—	dB	
	—	1075 to 1090 MHz	20	23	—	dB	
Inband VSWR	—	1000 to 1015 MHz	—	1.5	2.2	—	

9. PDC1.5G (Tx) Part number: FAR-F6CH-1G4410-S2Z1

(T_a = -30 to +85°C)

Parameter	Symbol	Condition	Value			Unit	Remarks
			Min.	Typ.	Max.		
Insertion loss	IL	1429 to 1453 MHz	—	1.6	2.5	dB	
Inband ripple	—	1429 to 1453 MHz	—	0.9	1.5	dB	
Absolute attenuation	—	1200 to 1335 MHz	20	26	—	dB	
	—	1335 to 1380 MHz	17	20	—	dB	
	—	1477 to 1501 MHz	5	8	—	dB	
	—	1601 to 1631 MHz	25	28	—	dB	
Inband VSWR	—	1429 to 1453 MHz	—	1.3	2.0	—	

F5/F6 Series (S2) Soft SAW

10. PDC1.5G (Rx)

Part number: FAR-F6CH-1G4890-S2Z2

(T_a = -30 to +85°C)

Parameter	Symbol	Condition	Value			Unit	Remarks
			Min.	Typ.	Max.		
Insertion loss	IL	1477 to 1501 MHz	—	1.5	2.5	dB	
Inband ripple	—	1477 to 1501 MHz	—	0.5	1.5	dB	
Absolute attenuation	—	1217 to 1241 MHz	20	23	—	dB	
	—	1347 to 1371 MHz	20	25	—	dB	
	—	1429 to 1453 MHz	10	13	—	dB	
	—	1607 to 1631 MHz	20	23	—	dB	
—	1737 to 1761 MHz	25	28	—	dB		
Inband VSWR	—	1477 to 1501 MHz	—	1.5	2.0	—	

11. PDC1.5G (Lo)

Part number: FAR-F6CH-1G3590-S2Z3

(T_a = -30 to +85°C)

Parameter	Symbol	Condition	Value			Unit	Remarks
			Min.	Typ.	Max.		
Insertion loss	IL	1347 to 1371 MHz	—	1.9	2.5	dB	
Inband ripple	—	1347 to 1371 MHz	—	0.5	1.5	dB	
Absolute attenuation	—	950 to 1150 MHz	15	18	—	dB	
	—	1150 to 1270 MHz	20	23	—	dB	
	—	1429 to 1600 MHz	20	23	—	dB	
	—	1600 to 1750 MHz	25	28	—	dB	
Inband VSWR	—	1347 to 1371 MHz	—	1.5	2.0	—	

12. PDC1.5G (Lo)

Part number: FAR-F6CH-1G6190-S2Z4

(T_a = -30 to +85°C)

Parameter	Symbol	Condition	Value			Unit	Remarks
			Min.	Typ.	Max.		
Insertion loss	IL	1607 to 1631 MHz	—	1.7	2.5	dB	
Inband ripple	—	1607 to 1631 MHz	—	0.6	1.5	dB	
Absolute attenuation	—	1280 to 1501 MHz	17	23	—	dB	
	—	1501 to 1550 MHz	15	18	—	dB	
	—	1730 to 1920 MHz	25	28	—	dB	
Inband VSWR	—	1607 to 1631 MHz	—	1.5	2.0	—	

F5/F6 Series (S2) Soft SAW

TYPICAL CHARACTERISTICS

1. AMPS/ADC (Tx) Part number: FAR-F5CH-836M50-S2A1

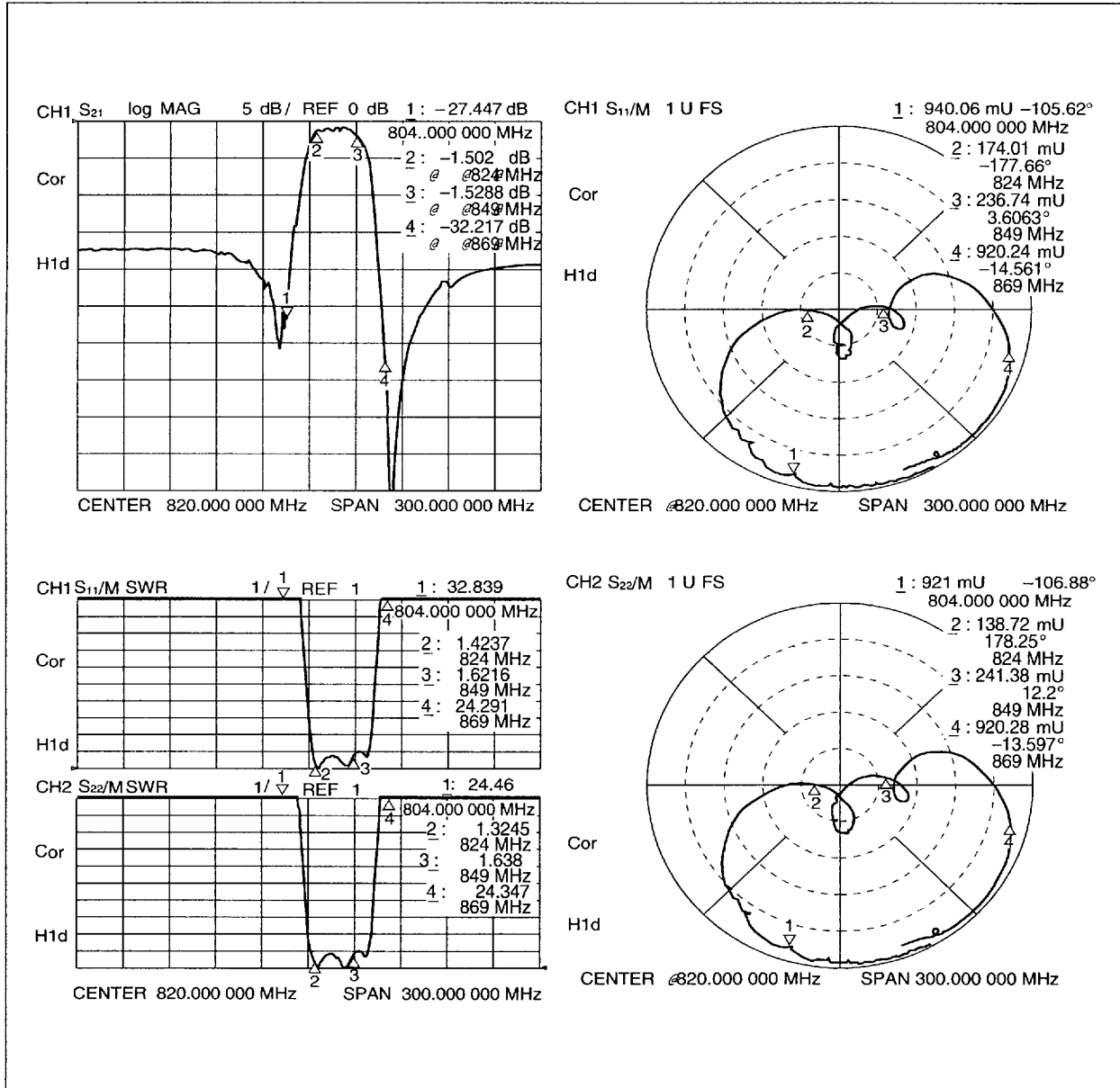

F5/F6 Series (S2) Soft SAW

2. AMPS/ADC (Rx) Part number: FAR-F5CH-881M50-S2A2

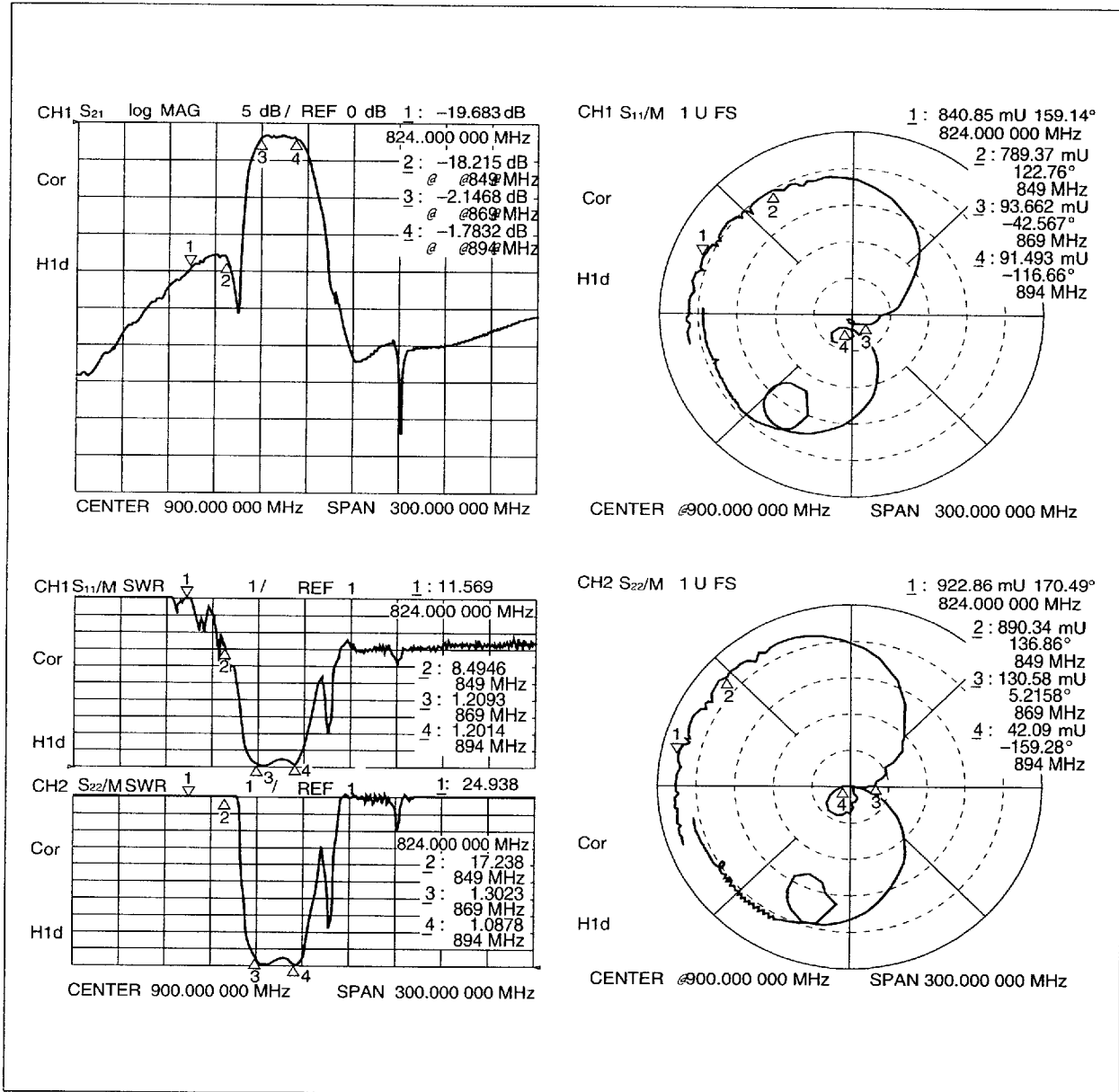

3749756 0024866 T9T

F5/F6 Series (S2) Soft SAW

3. NMT/GSM (Tx)

Part number: FAR-F5CH-902M50-S2E1

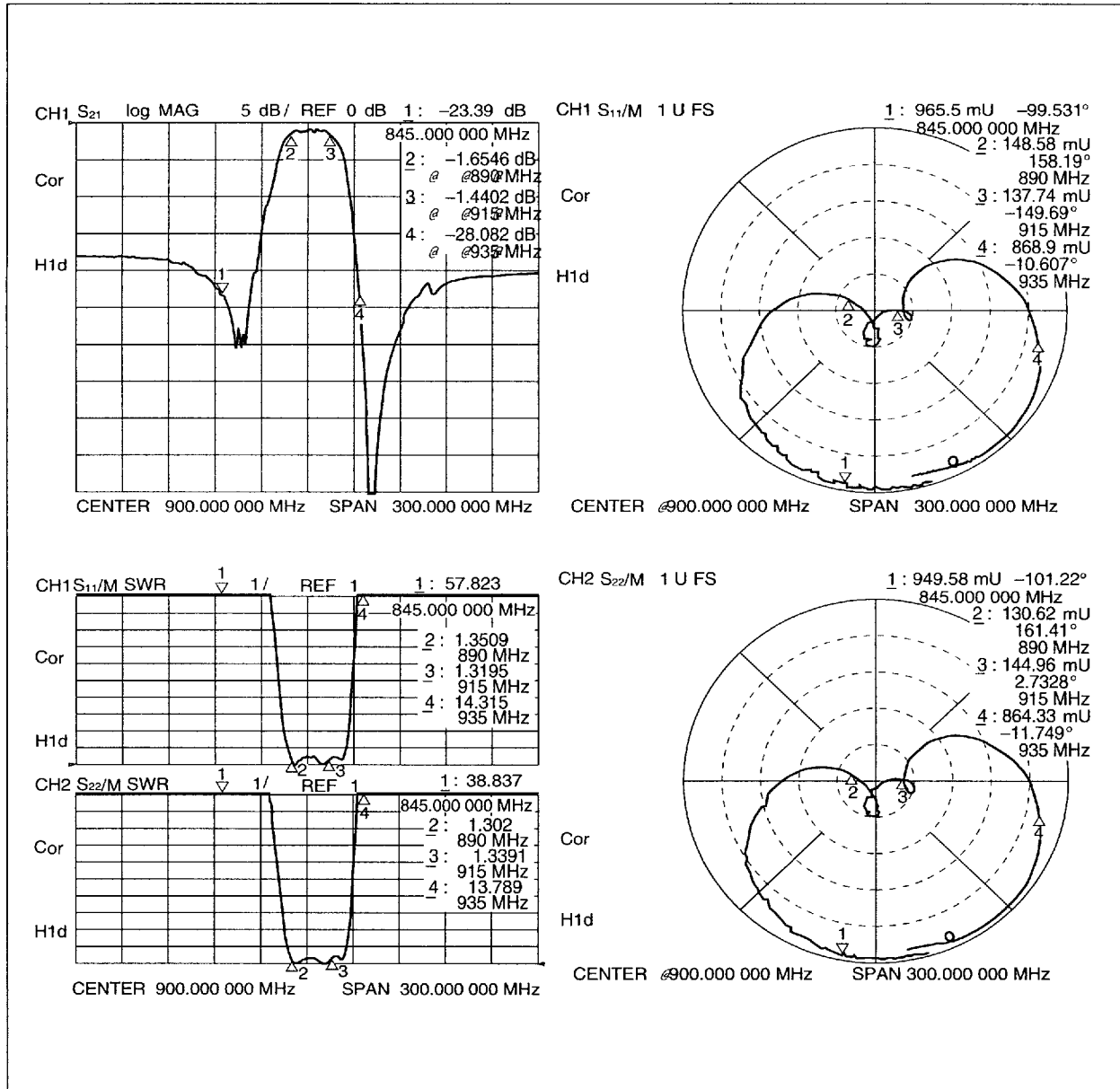

F5/F6 Series (S2) Soft SAW

4. NMT/GSM (Rx) Part number: FAR-F5CH-947M50-S2E2

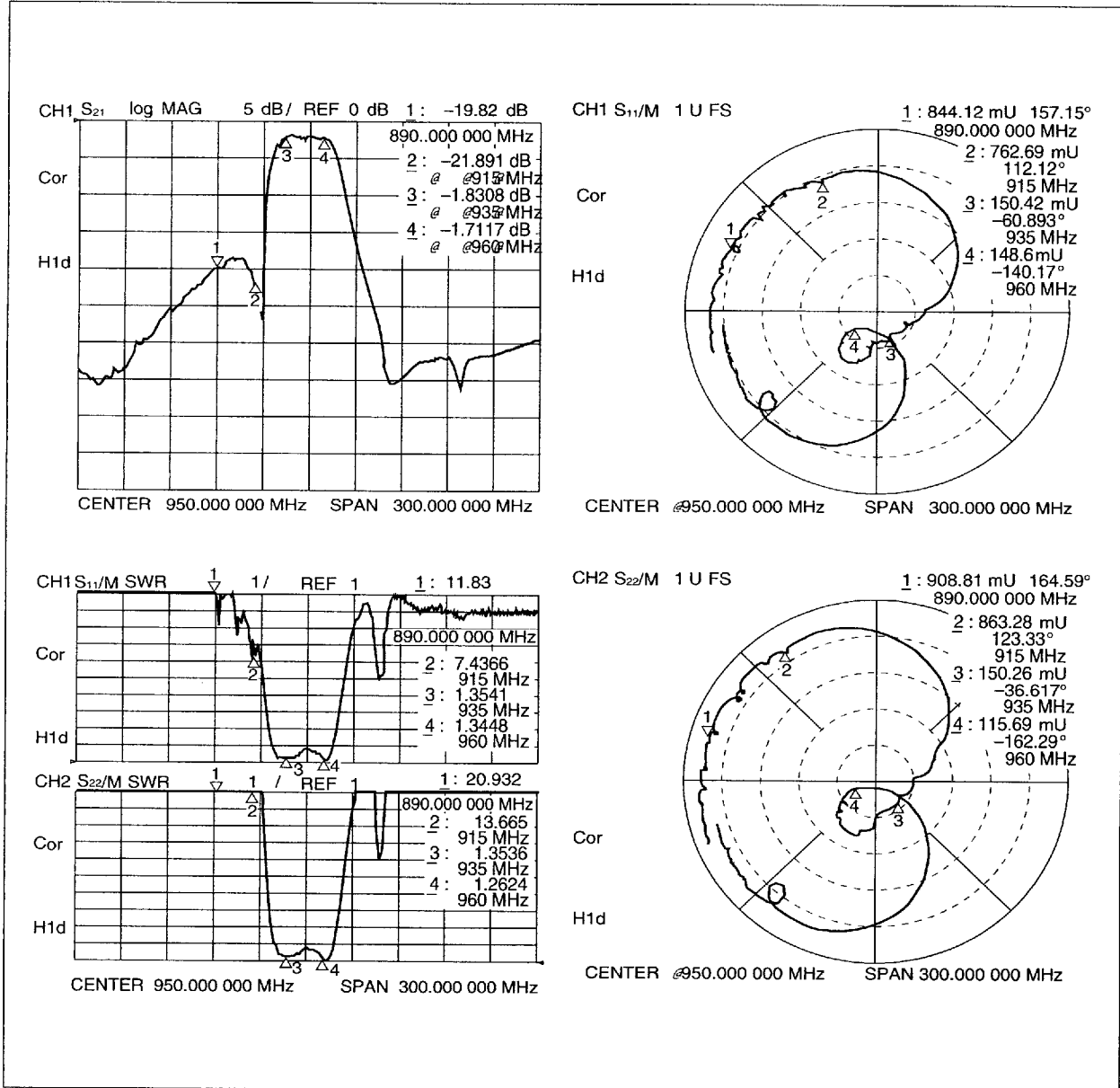

3749756 0024868 862

F5/F6 Series (S2) Soft SAW

5. PDC800 (Tx) Part number: FAR-F5CH-950M00-S2F1

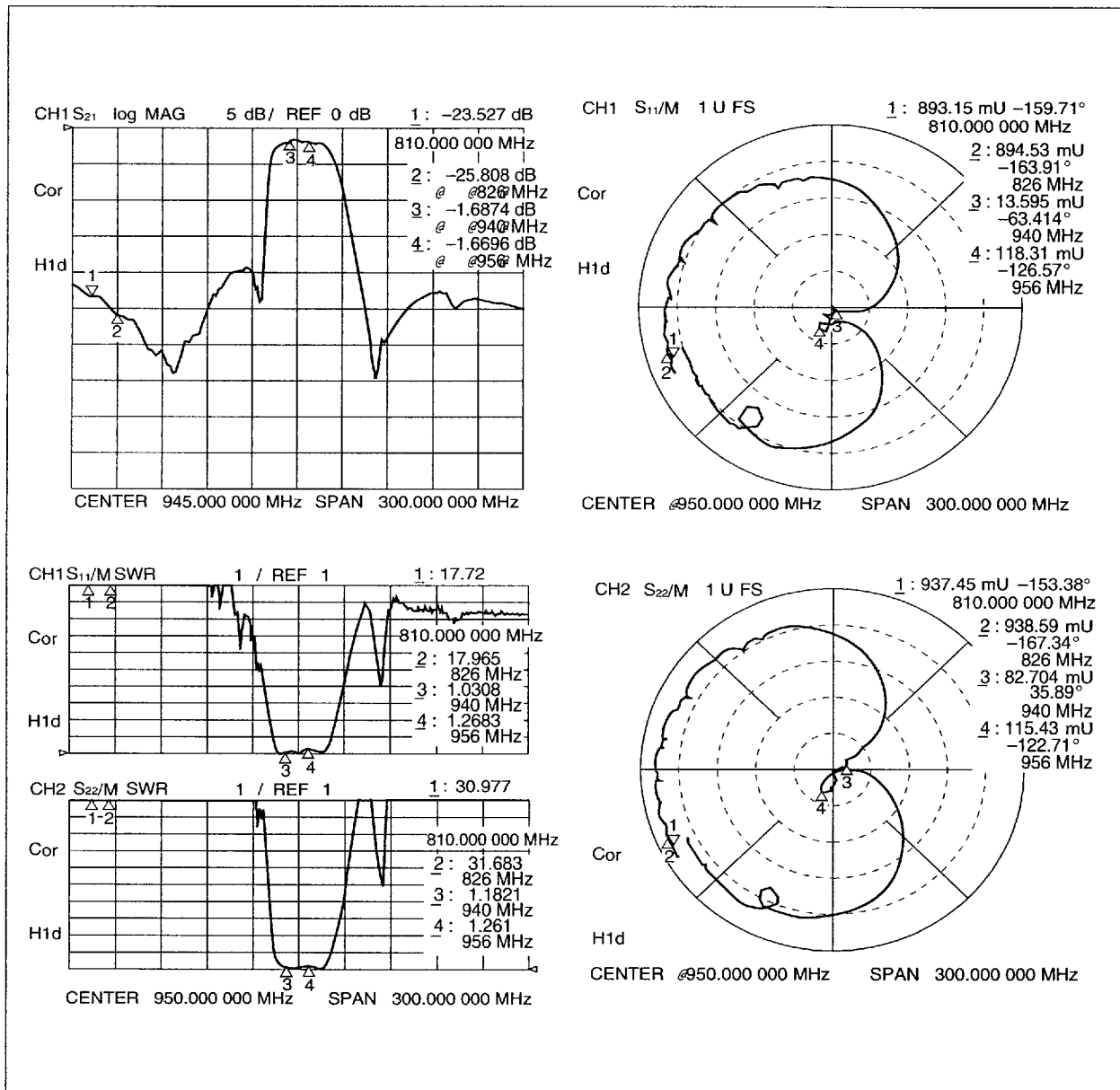

F5/F6 Series (S2) Soft SAW

6. PDC800 (Rx) Part number: FAR-F5CH-820M00-S2F2

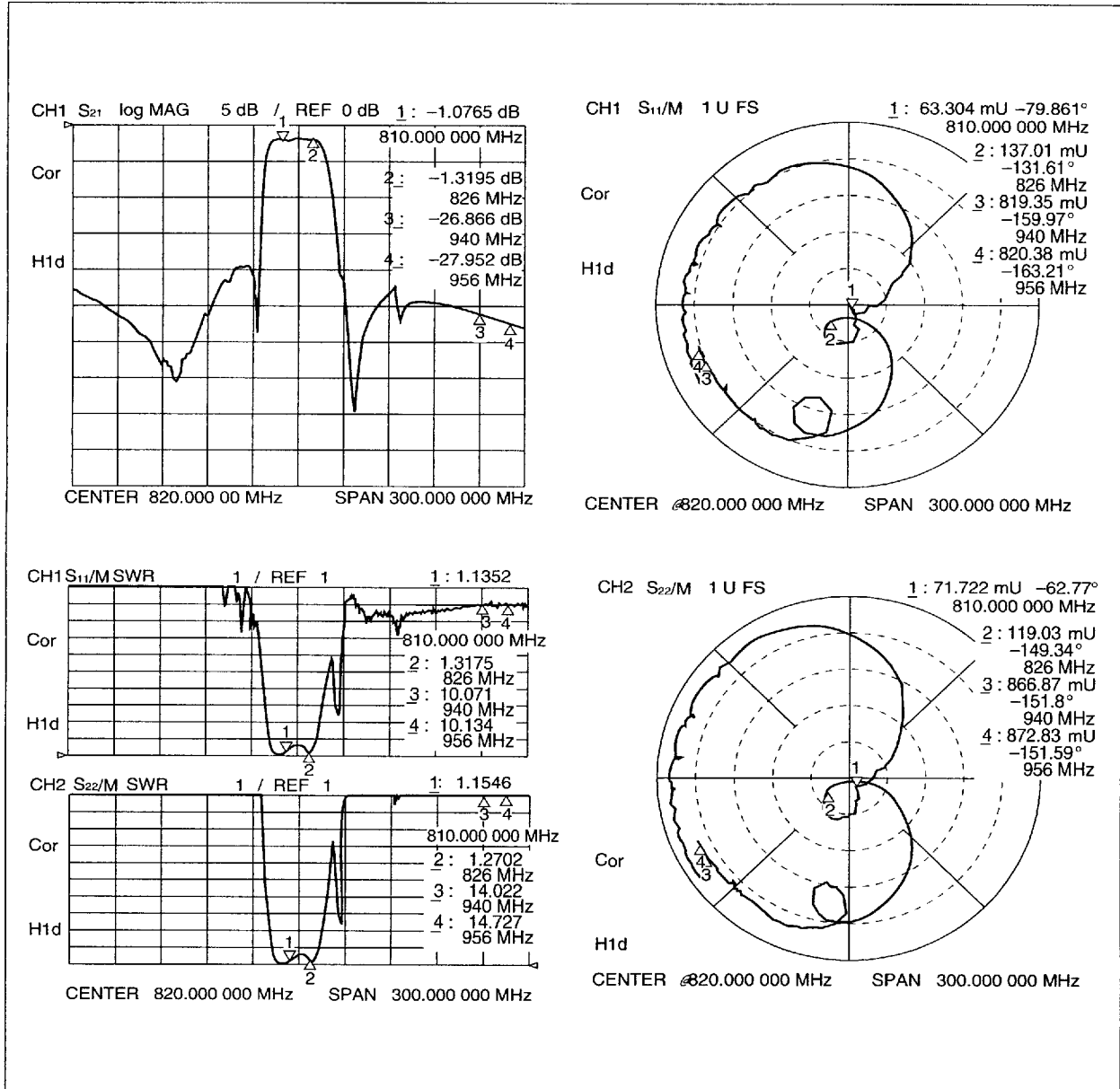

3749756 0024870 410

F5/F6 Series (S2) Soft SAW

7. Dual Band PDC800 (Tx) Part number: FAR-F5CH-940M50-S2M1

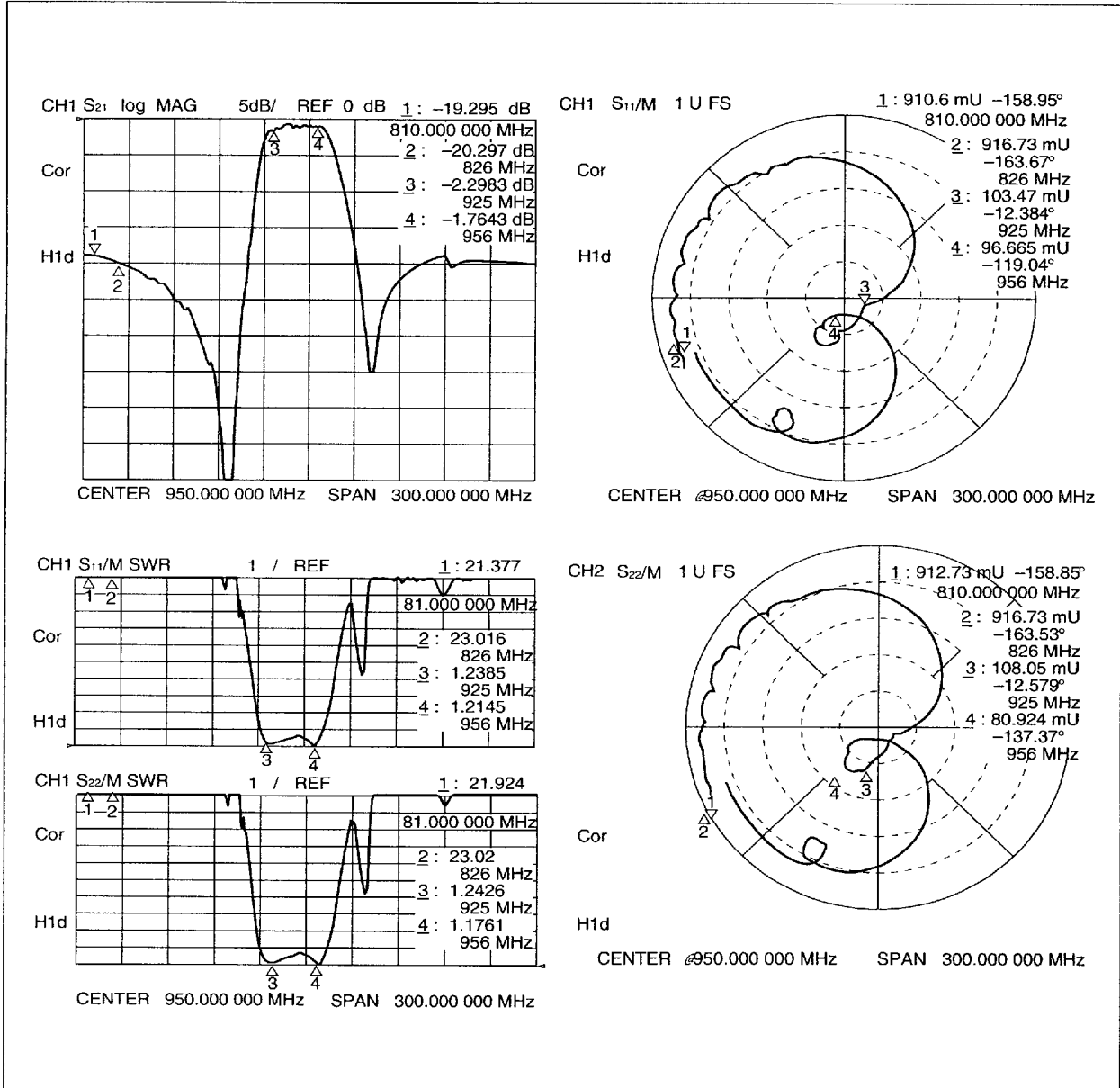

F5/F6 Series (S2) Soft SAW

8. Dual Band PDC800 (Lo) Part number: FAR-F6CH-1G0075-S2M3

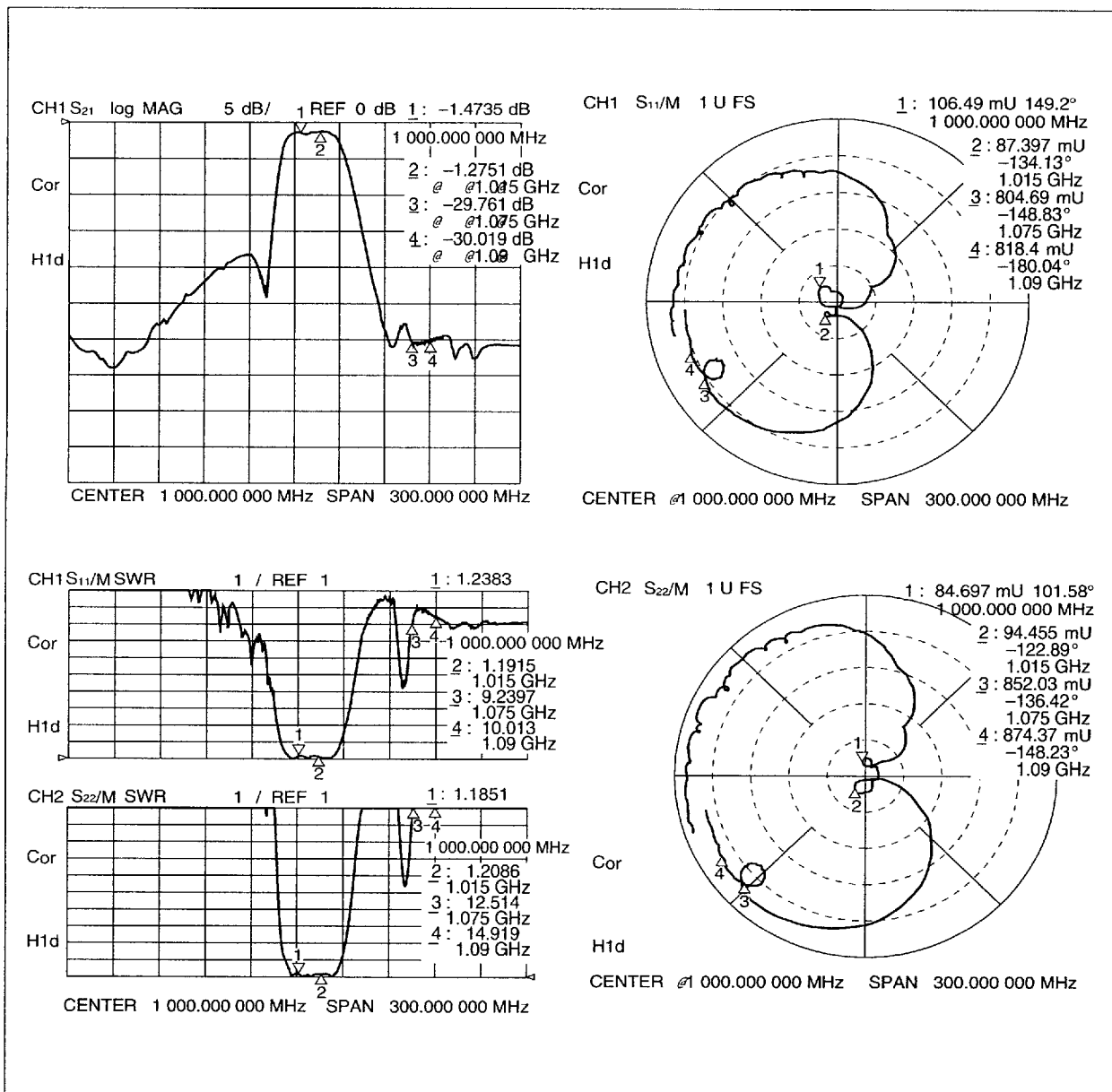

F5/F6 Series (S2) Soft SAW

9. PDC1.5G (Tx) Part number: FAR-F6CH-1G4410-S2Z1

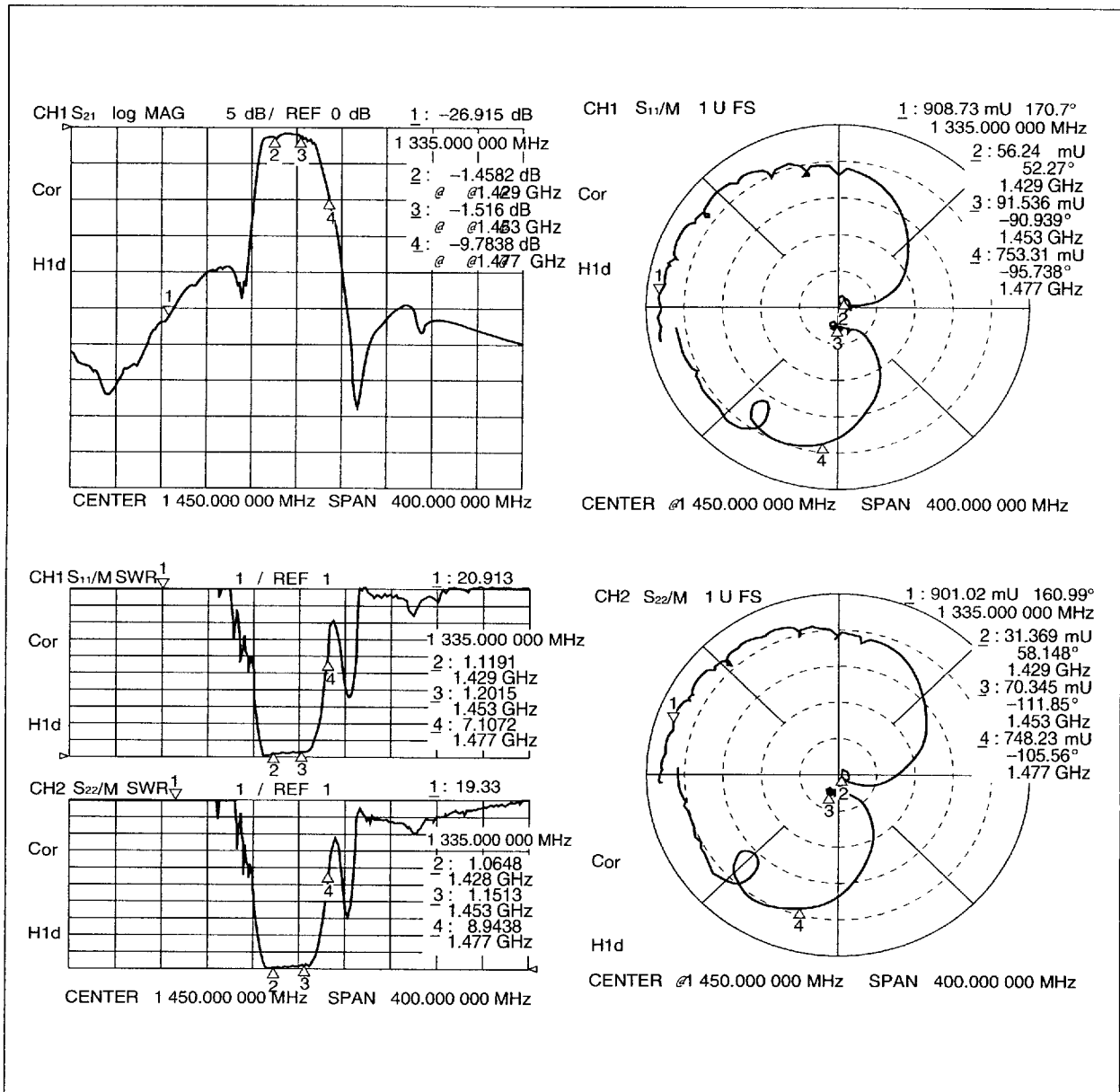

F5/F6 Series (S2) Soft SAW

10. PDC1.5G (Rx)

Part number: FAR-F6CH-1G4890-S2Z2

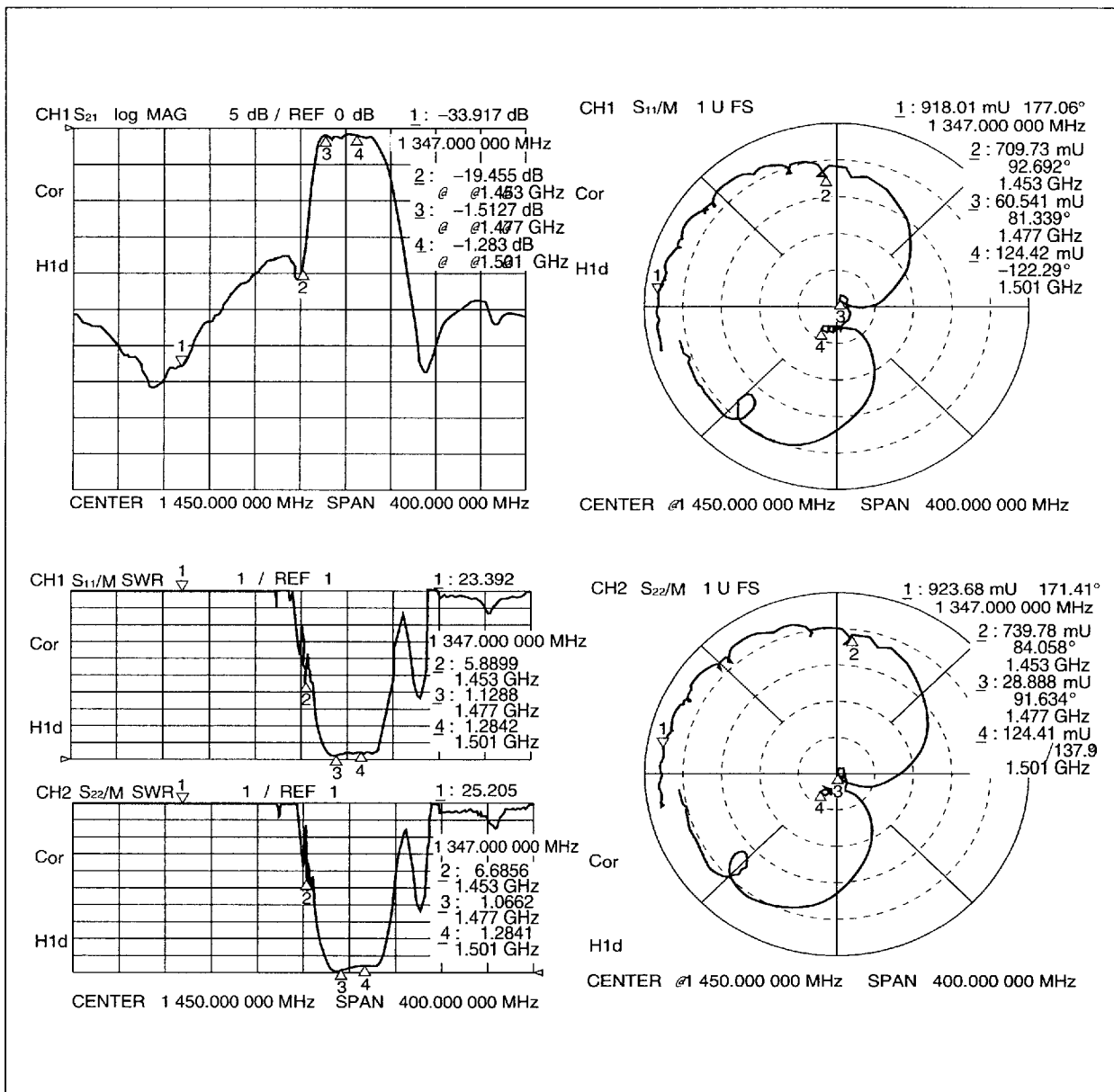

F5/F6 Series (S2) Soft SAW

11. PDC1.5G (Lo)

Part number: FAR-F6CH-1G3590-S2Z3

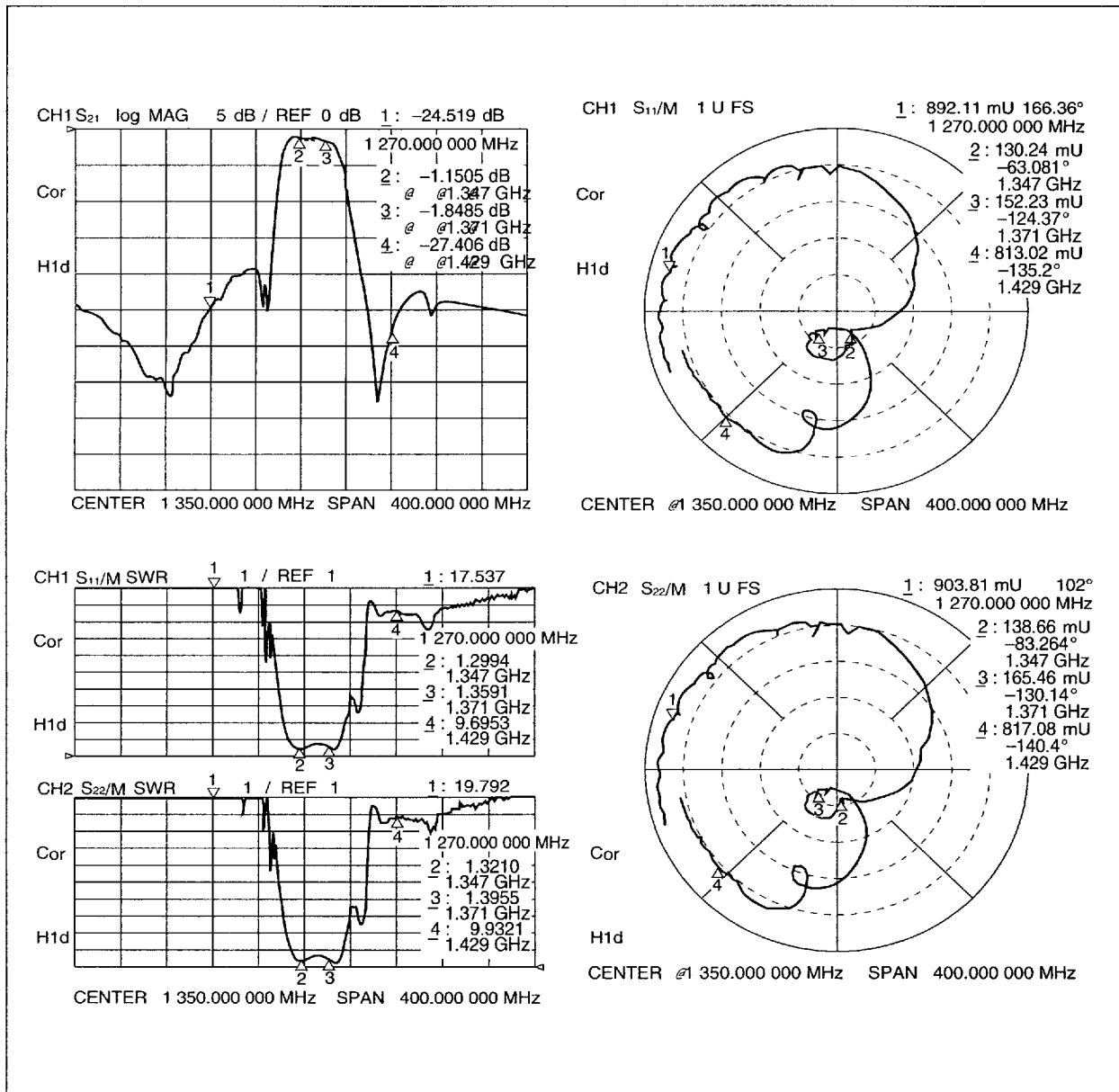

F5/F6 Series (S2) Soft SAW

12. PDC1.5G (Lo)

Part number: FAR-F6CH-1G6190-S2Z4

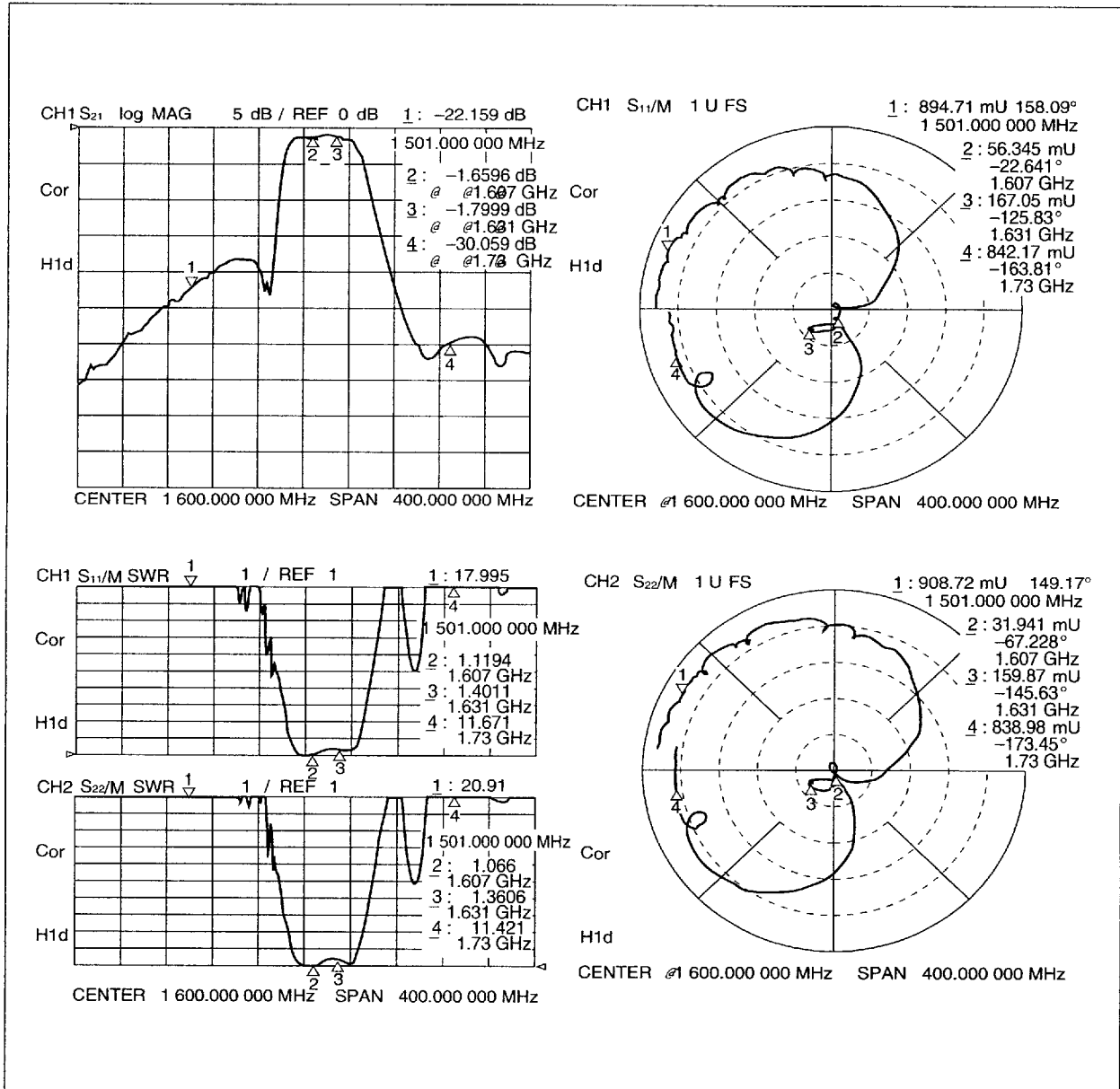

F5/F6 Series (S2) Soft SAW

MEASURING CIRCUIT

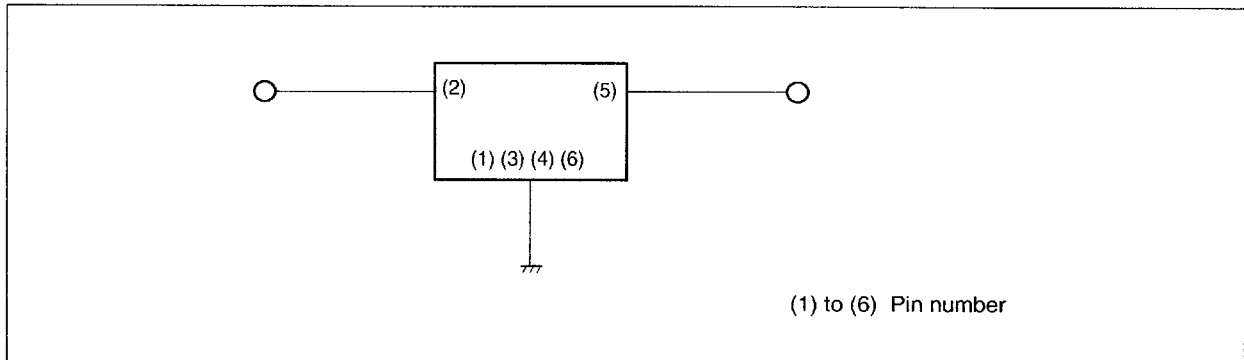

PART NUMBER DESIGNATION

[Designation example]

FAR-F□CH-□□□□□□-S2□□-□
 (1) (2) (3) (4)

- (1) Frequency: 5: 700 to 1000 MHz
6: 1000 to 1700 MHz
- (2) Frequency designation: Specify the nominal frequency in six alphanumeric characters. Enter M (for MHz) or G (for GHz) at the decimal point. Refer to standard frequencies.

[Example] 836.5 MHz → 836M50
 1.441 GHz → 1G4410

- (3) Serial number: Specified a characters from A1 to Z4. Refer to standard frequencies.
- (4) Packing (Reeled tape): T: 1 k pcs/reel
R: 3 k pcs/reel

F5/F6 Series (S2) Soft SAW

■ PACKAGE DIMENSION

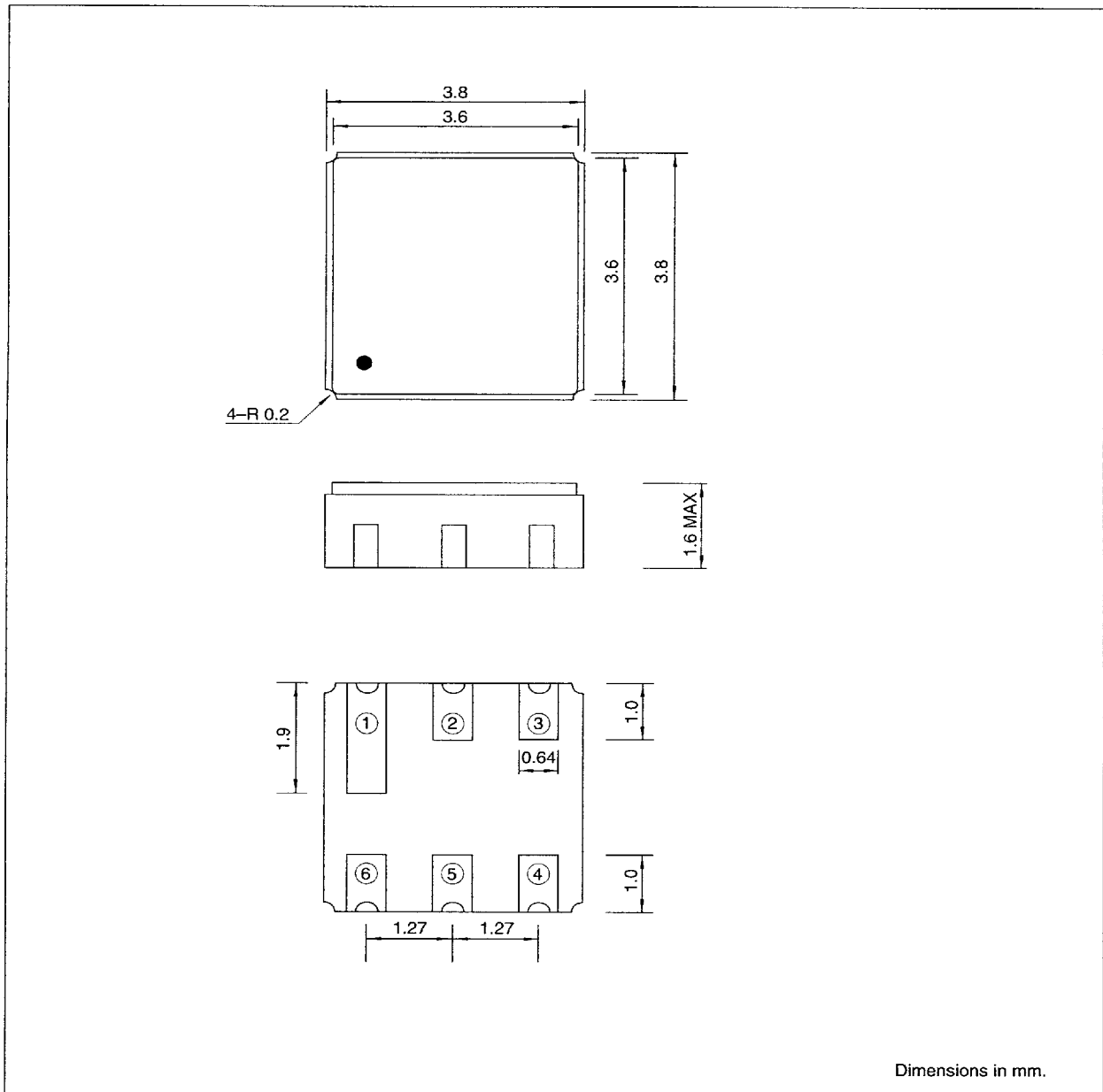

F5/F6 Series (S2) Soft SAW

■ MARKING

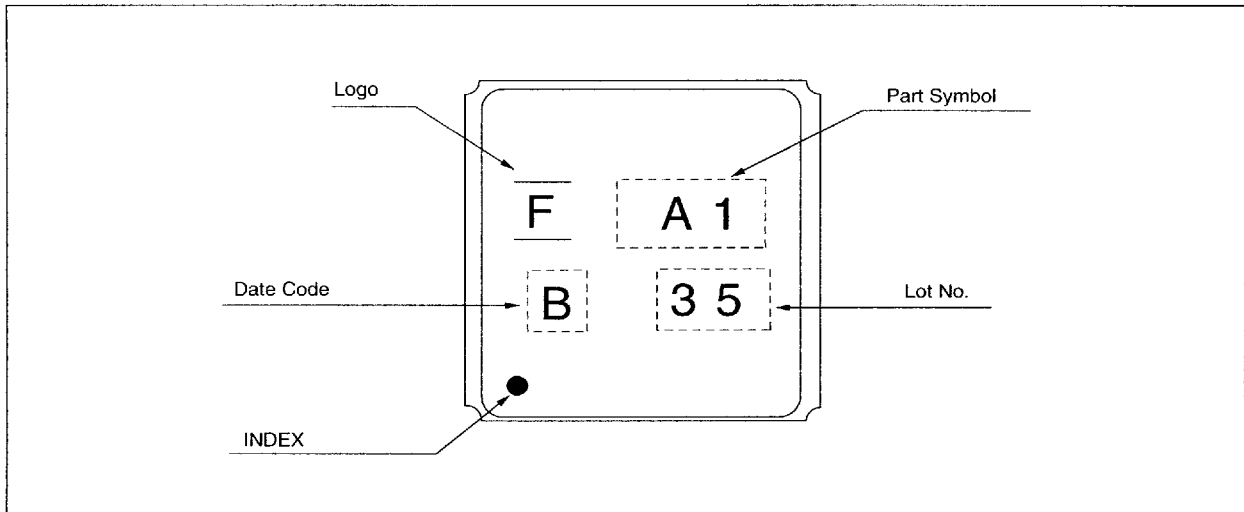

F5/F6 Series (S2) Soft SAW

PACKING: Reel type

(1) Reel Dimensions

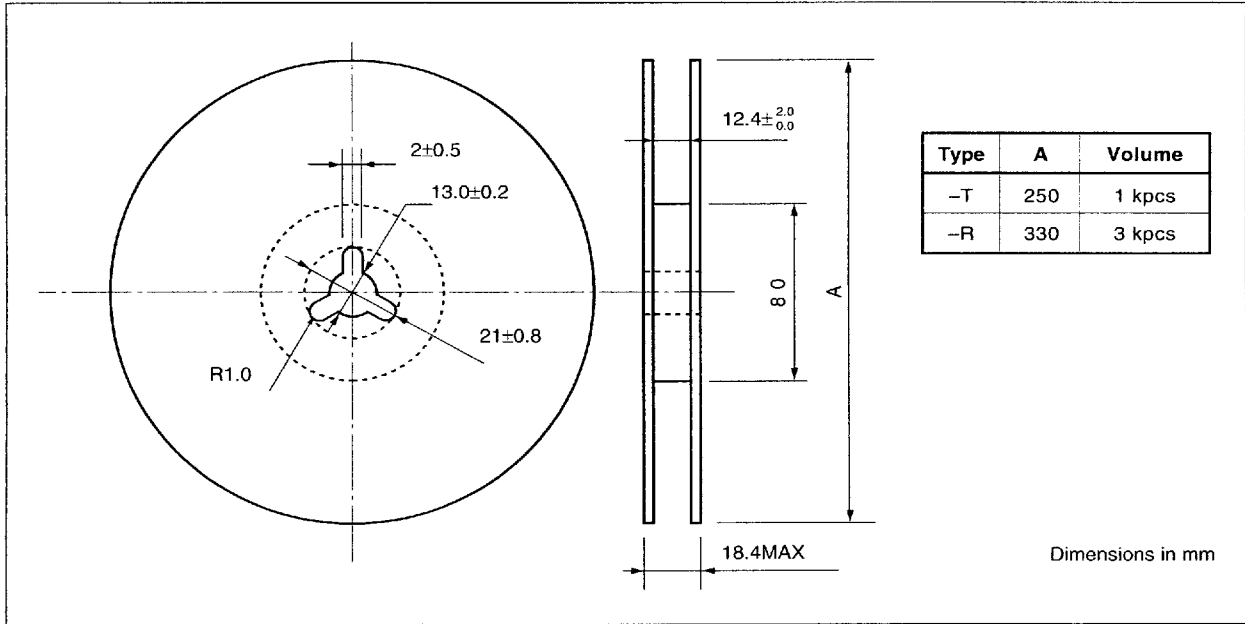

(2) Packing Style

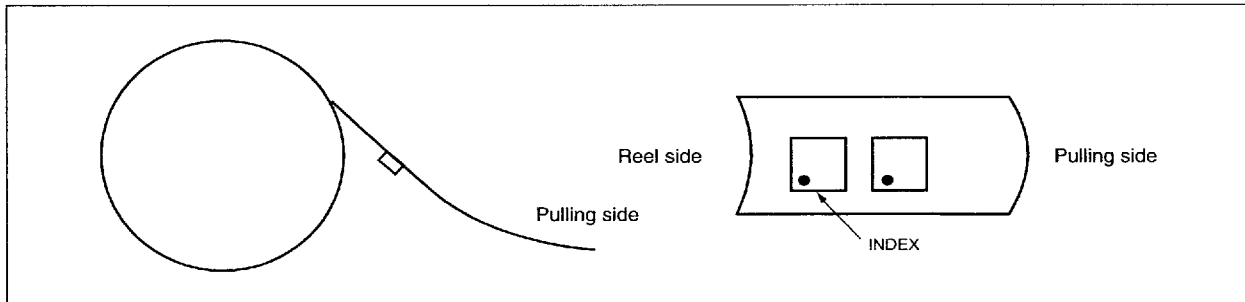

(3) Tape Dimensions

