



# Silicon Bipolar RFIC Amplifiers

## Technical Data

### Features

#### MSA-2011

- **Surface Mount SOT-143 Package**
- **3 dB Bandwidth:**  
DC to 1.0 GHz
- **16.2 dB Gain at 1 GHz**
- **4.3 dB NF at 1 GHz**

#### MSA-2035

- **Hermetic Ceramic Package**
- **3 dB Bandwidth:**  
DC to 1.1 GHz
- **17.3 dB Gain at 1 GHz**
- **3.7 dB NF at 1 GHz**

#### MSA-2085

- **Plastic Microstrip Package**
- **3 dB Bandwidth:**  
DC to 1.1 GHz
- **16.6 dB Gain at 1 GHz**
- **3.7 dB NF at 1 GHz**

#### MSA-2086

- **Surface Mount Plastic Microstrip Package**
- **3 dB Bandwidth:**  
DC to 1.1 GHz
- **16.6 dB Gain at 1 GHz**
- **3.7 dB NF at 1 GHz**

**MSA-2011**

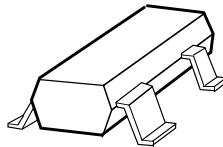

**MSA-2035**

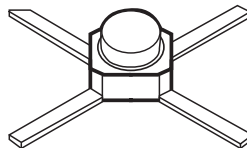

**MSA-2085**

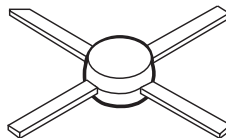

**MSA-2086**

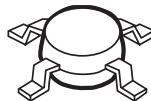

### MSA-20xx Series

#### Description

The MSA-20xx series are high performance silicon bipolar RFIC amplifiers designed to be cascadable in 50  $\Omega$  systems. The stability factor of  $K > 1$  contributes to easy cascading in numerous narrow and broadband IF and RF commercial and industrial applications.

The MSA series is fabricated using a 10 GHz  $f_T$ , 25 GHz  $F_{MAX}$ , silicon bipolar RFIC process which utilizes nitride self-alignment, ion implantation, and gold metallization to achieve excellent uniformity, performance, and reliability. The use of an external bias resistor for temperature and current stability also allows bias flexibility.

Package options include the industry standard plastic surface mount SOT-143 package, the 100 mil surface mountable hermetic ceramic package, the 85 mil plastic microstripline package, and the 85 mil surface mountable plastic microstripline package.

## Absolute Maximum Ratings<sup>[1]</sup>

Parameter	MSA-2011	MSA-2035	MSA-2085, -2086
Device Current	50 mA	60 mA	60 mA
Power Dissipation <sup>[2,3]</sup>	250 mW <sup>[3a]</sup>	325 mW <sup>[3b]</sup>	325 mW <sup>[3c]</sup>
RF Input Power	+13 dBm	+13 dBm	+13 dBm
Junction Temperature	150°C	200°C	150°C
Storage Temperature	-65 to 150°C	-65 to 200°C	-65 to 150°C
Thermal Resistance: $\theta_{jc}$	500°C/W	155°C/W	115°C/W

### Notes:

- Permanent damage may occur if any of these limits are exceeded.
- $T_{CASE} = 25^{\circ}C$ .
- Derate at 2.0 mW/°C for  $T_C > 25^{\circ}C$ .
  - Derate at 6.5 mW/°C for  $T_C > 149^{\circ}C$ .
  - Derate at 8.7 mW/°C for  $T_C > 112^{\circ}C$ .

## Electrical Specifications, $T_A = 25^{\circ}C$

$I_D = 32$  mA,  $Z_0 = 50 \Omega$

Symbol	Parameters and Test Conditions	Units	MSA-2011			MSA-2035			MSA-2085, -2086		
			Min.	Typ.	Max.	Min.	Typ.	Max.	Min.	Typ.	Max.
$G_p$	Power Gain ( $ S_{21} ^2$ ) f = 0.1 GHz f = 0.5 GHz f = 1.0 GHz	dB		18.9		17.8	19.2	19.8		19.2	
			15.0	18.1		18.7		15.0	18.3		
				16.2		17.3		16.6			
$\Delta G_p$	Gain Flatness f = 0.1 to 0.6 GHz	dB		±0.6		±0.4	±1.0		±0.6		
$f_{3dB}$	3 dB Bandwidth	GHz		1.0		1.1			1.1		
VSWR	Input VSWR f = 0.1 to 3.0 GHz			1.3:1		1.3:1			1.2:1		
	Output VSWR f = 0.1 to 3.0 GHz			1.4:1		1.4:1			1.5:1		
$P_{1dB}$	Power Output @ 1 dB Gain Compression: f = 1.0 GHz	dBm		9.0		9.5			9.0		
NF	50 $\Omega$ Noise Figure f = 1.0 GHz	dB		4.3		3.7			3.7		
$IP_3$	Third Order Intercept Point f = 1.0 GHz	dBm		22		22			22		
$t_d$	Group Delay f = 1.0 GHz	psec		143		143			143		
$V_D$	Device Voltage $T_C = 25^{\circ}C$	V	4.0	5.0	6.0	4.5	5.0	5.5	4.3	5.0	6.3
dV/dT	Device Voltage Temperature Coefficient	mV/°C		-9.3		-9.3			-9.3		

### Note:

- Refer to "Tape and Reel Packaging for Surface Mount Devices."

## Typical Biasing Configuration

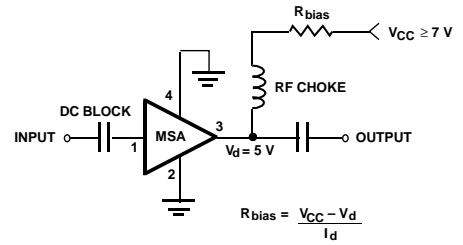

## Typical Performance for MSA-2011

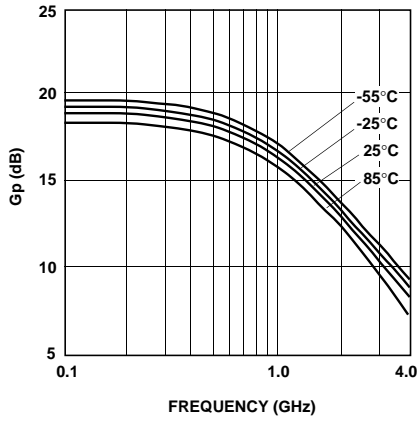

Figure 1. Power Gain vs. Frequency at Four Temperatures,  $I_D = 32$  mA.

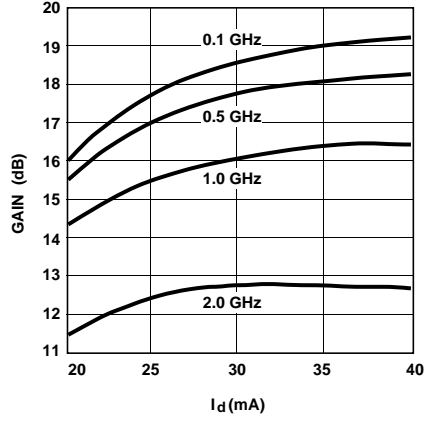

Figure 2. Power Gain vs. Current at 25°C.

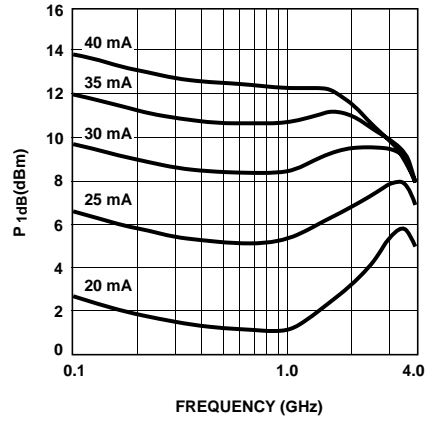

Figure 3. Typical  $P_{1dB}$  vs. Frequency at 25°C.

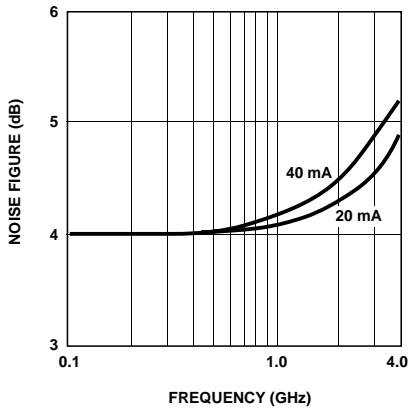

Figure 4. Noise Figure vs. Frequency at  $I_D = 32$  mA.

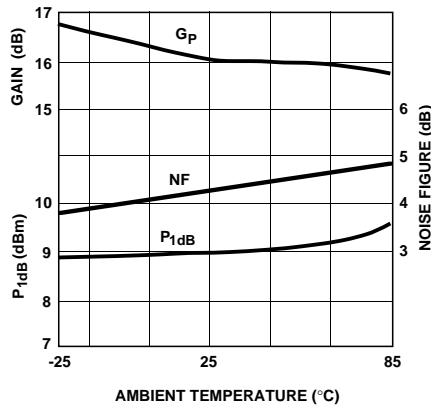

Figure 5. Power Gain, Noise Figure, and  $P_{1dB}$  vs. Temperature at 1 GHz and  $I_D = 32$  mA.

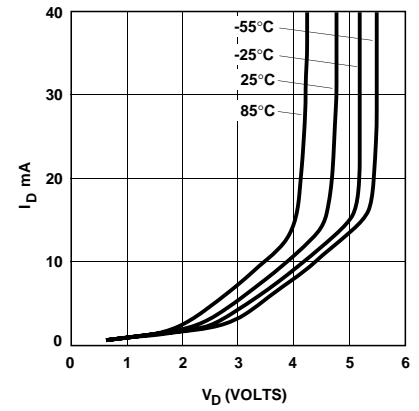

Figure 6.  $I_D$  vs.  $V_D$  at Four Temperatures.

## Typical Performance for MSA-2035

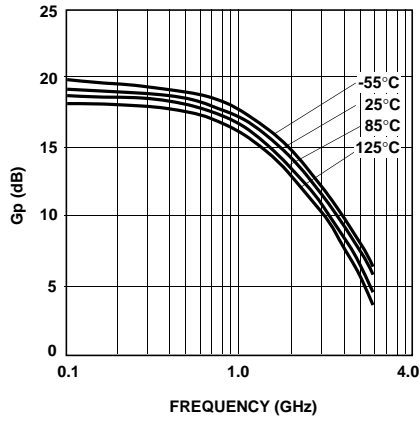

Figure 1. Power Gain vs. Frequency at Four Temperatures,  $I_D = 32$  mA.

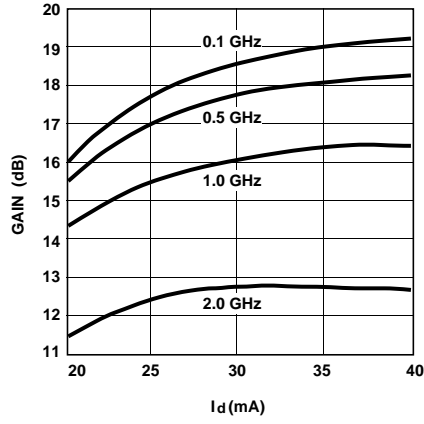

Figure 2. Power Gain vs. Current at 25°C.

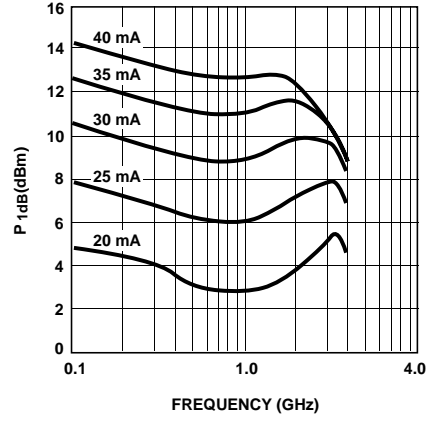

Figure 3. Typical  $P_{1dB}$  vs. Frequency at 25°C.

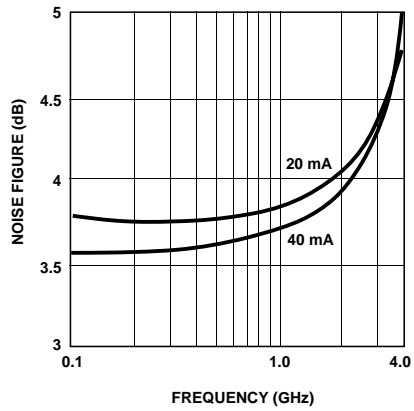

Figure 4. Noise Figure vs. Frequency at  $I_D = 32$  mA.

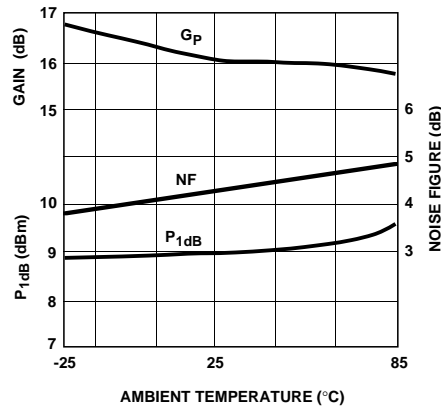

Figure 5. Power Gain, Noise Figure, and  $P_{1dB}$  vs. Temperature at 1 GHz and  $I_D = 32$  mA.

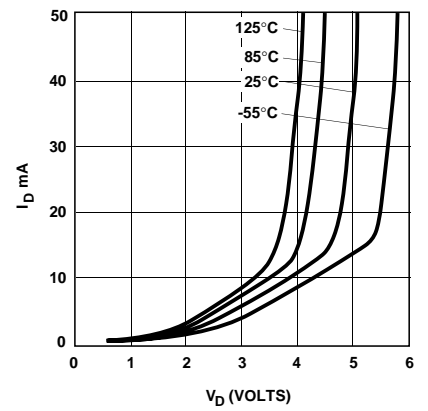

Figure 6.  $I_D$  vs.  $V_D$  at Four Temperatures.

### Typical Scattering Parameters at $T_A = 25^\circ\text{C}$ , for MSA-2011

$I_D = 32 \text{ mA}$ ,  $Z_0 = 50 \Omega$

Frequency (GHz)	$S_{11}$		$S_{21}$			$S_{12}$			$S_{22}$	
	Mag.	Ang.	(dB)	Mag.	Ang.	(dB)	Mag.	Ang.	Mag.	Ang.
0.1	0.05	7	18.9	8.81	172	-22.6	0.074	4	0.17	-13
0.2	0.05	9	18.8	8.73	165	-22.4	0.076	8	0.17	-23
0.3	0.06	3	18.6	8.52	157	-22.2	0.077	11	0.17	-34
0.4	0.06	1	18.3	8.25	150	-22.0	0.079	15	0.17	-43
0.5	0.06	0	18.1	8.00	143	-21.7	0.082	17	0.17	-52
0.6	0.07	-5	17.7	7.65	137	-21.4	0.085	20	0.17	-61
0.7	0.07	-8	17.3	7.33	131	-21.1	0.088	22	0.17	-68
0.8	0.08	-12	16.9	7.02	125	-20.7	0.092	24	0.17	-74
0.9	0.08	-18	16.3	6.70	120	-20.3	0.096	26	0.18	-80
1.0	0.08	-22	16.2	6.43	115	-20.0	0.100	28	0.18	-85
1.5	0.09	-46	14.3	5.16	93	-18.2	0.123	31	0.18	-102
2.0	0.11	-69	12.6	4.26	75	-16.7	0.146	31	0.17	-109
2.5	0.11	-93	11.2	3.64	59	-15.6	0.167	29	0.17	-111
3.0	0.12	-118	10.1	3.18	45	-14.7	0.185	26	0.18	-112
3.5	0.12	-152	9.1	2.85	31	-13.9	0.202	24	0.19	-116
4.0	0.15	174	8.1	2.55	18	-13.3	0.216	21	0.20	-124
4.5	0.22	147	7.4	2.33	5	-12.8	0.231	19	0.22	-133
5.0	0.30	127	6.5	2.11	-8	-12.2	0.246	17	0.25	-145
5.5	0.39	113	5.6	1.90	-20	-11.4	0.268	14	0.30	-157
6.0	0.45	100	4.5	1.68	-32	-10.7	0.292	10	0.35	-168

### Typical Scattering Parameters at $T_A = 25^\circ\text{C}$ , for MSA-2035

$I_D = 32 \text{ mA}$ ,  $Z_0 = 50 \Omega$

Frequency (GHz)	$S_{11}$		$S_{21}$			$S_{12}$			$S_{22}$	
	Mag.	Ang.	(dB)	Mag.	Ang.	(dB)	Mag.	Ang.	Mag.	Ang.
0.1	0.05	-2	19.2	9.13	174	-22.8	0.072	3	0.18	-11
0.2	0.06	-3	19.1	9.05	167	-22.7	0.073	6	0.18	-20
0.3	0.06	-7	19.0	8.94	160	-22.6	0.075	9	0.18	-29
0.4	0.06	-10	18.9	8.77	154	-22.4	0.076	11	0.18	-38
0.5	0.06	-14	18.7	8.58	147	-22.2	0.078	14	0.18	-47
0.6	0.07	-22	18.4	8.35	141	-21.9	0.080	16	0.17	-55
0.7	0.07	-27	18.2	8.10	135	-21.6	0.083	17	0.17	-63
0.8	0.07	-32	17.9	7.86	130	-21.3	0.086	19	0.17	-71
0.9	0.07	-37	17.6	7.59	124	-21.0	0.089	20	0.17	-79
1.0	0.07	-42	17.3	7.33	119	-20.7	0.092	22	0.16	-86
1.5	0.08	-74	15.7	6.11	96	-19.1	0.111	24	0.16	-117
2.0	0.09	-108	14.2	5.15	76	-17.8	0.130	23	0.16	-140
2.5	0.12	-136	12.9	4.42	59	-16.6	0.148	20	0.15	-155
3.0	0.15	-162	11.7	3.86	43	-15.7	0.164	16	0.15	-169
3.5	0.19	176	10.7	3.41	27	-15.1	0.176	11	0.16	-178
4.0	0.25	158	9.7	3.04	12	-14.6	0.187	7	0.17	177
4.5	0.30	141	8.7	2.71	-1	-14.1	0.196	3	0.19	171
5.0	0.37	126	7.8	2.44	-16	-13.8	0.204	-1	0.22	161
5.5	0.43	112	6.8	2.17	-29	-13.5	0.212	-5	0.29	154
6.0	0.49	100	5.7	1.92	-42	-13.1	0.222	-9	0.35	148

### Typical Performance for MSA-2085 and MSA-2086

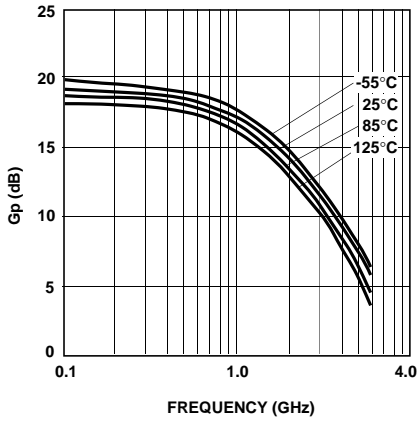

Figure 1. Power Gain vs. Frequency at Four Temperatures,  $I_D = 32$  mA.

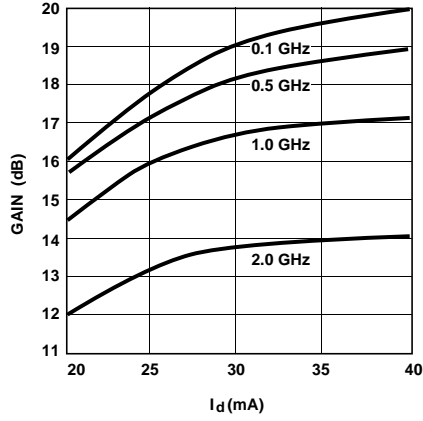

Figure 2. Power Gain vs. Current at 25°C.

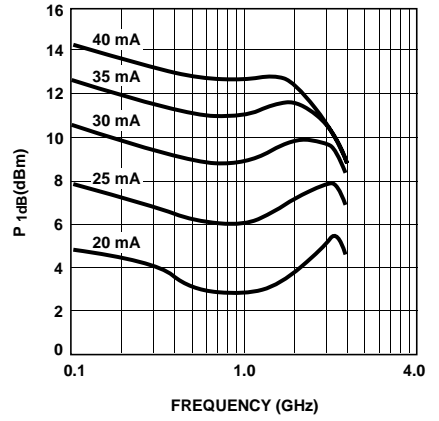

Figure 3. Typical  $P_{1dB}$  vs. Frequency at 25°C.

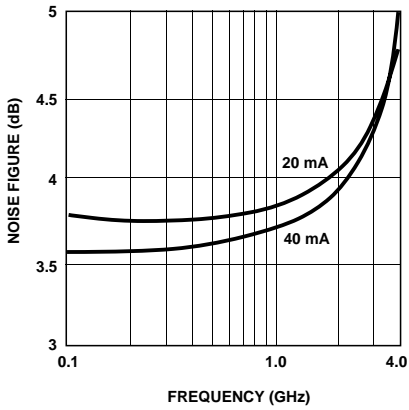

Figure 4. Noise Figure vs. Frequency at  $I_D = 32$  mA.

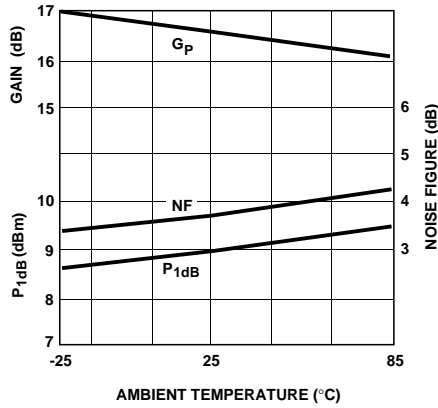

Figure 5. Power Gain, Noise Figure, and  $P_{1dB}$  vs. Temperature at 1 GHz and  $I_D = 32$  mA.

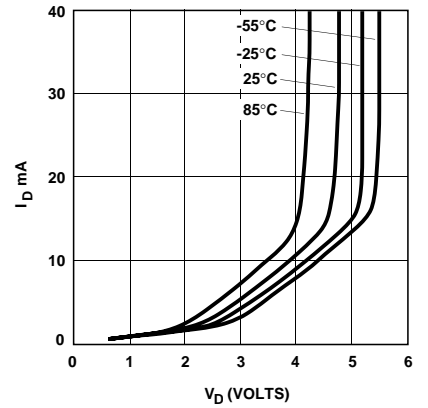

Figure 6.  $I_D$  vs.  $V_D$  at Four Temperatures.

### Typical Scattering Parameters at $T_A = 25^\circ\text{C}$ , for MSA-2085

$I_D = 32\text{ mA}$ ,  $Z_o = 50\ \Omega$

Frequency (GHz)	$S_{11}$		$S_{21}$			$S_{12}$			$S_{22}$	
	Mag.	Ang.	(dB)	Mag.	Ang.	(dB)	Mag.	Ang.	Mag.	Ang.
0.1	0.05	4	19.2	9.11	173	-22.7	0.073	4	0.18	-14
0.2	0.05	-6	19.1	9.00	166	-22.6	0.075	8	0.18	-27
0.3	0.05	-14	18.9	8.79	159	-22.4	0.076	11	0.18	-38
0.4	0.07	-13	18.6	8.53	152	-22.2	0.078	14	0.19	-45
0.5	0.09	-17	18.3	8.26	146	-21.9	0.080	17	0.20	-51
0.6	0.08	-33	18.0	7.98	140	-21.6	0.083	19	0.21	-59
0.7	0.09	-44	17.7	7.71	135	-21.3	0.086	22	0.22	-68
0.8	0.09	-47	17.4	7.41	130	-20.9	0.090	24	0.22	-77
0.9	0.09	-54	17.0	7.06	125	-20.5	0.094	26	0.22	-85
1.0	0.10	-60	16.6	6.77	120	-20.2	0.098	27	0.22	-90
1.5	0.10	-78	14.9	5.58	99	-18.5	0.119	31	0.23	-116
2.0	0.13	-96	13.4	4.67	82	-17.1	0.140	31	0.21	-126
2.5	0.13	-113	12.0	3.97	67	-16.0	0.159	30	0.20	-137
3.0	0.14	-129	10.8	3.48	54	-15.0	0.177	27	0.20	-140
3.5	0.15	-153	9.8	3.10	41	-14.4	0.192	24	0.21	-143
4.0	0.18	-177	8.9	2.77	29	-13.9	0.202	22	0.22	-148
4.5	0.22	163	7.9	2.49	17	-13.5	0.212	19	0.24	-151
5.0	0.27	147	7.0	2.24	6	-13.2	0.218	17	0.28	-154
5.5	0.32	134	6.1	2.02	-5	-12.9	0.225	15	0.31	-159
6.0	0.37	123	5.2	1.82	-15	-12.6	0.235	14	0.35	-164

### Typical Scattering Parameters at $T_A = 25^\circ\text{C}$ , for MSA-2086

$I_D = 32\text{ mA}$ ,  $Z_o = 50\ \Omega$

Frequency (GHz)	$S_{11}$		$S_{21}$			$S_{12}$			$S_{22}$	
	Mag.	Ang.	(dB)	Mag.	Ang.	(dB)	Mag.	Ang.	Mag.	Ang.
0.1	0.06	1	19.2	9.08	172	-22.8	0.073	4	0.18	-15
0.2	0.05	-5	19.1	8.98	165	-22.6	0.074	7	0.17	-26
0.3	0.05	-10	18.9	8.80	157	-22.4	0.076	10	0.17	-37
0.4	0.07	-15	18.7	8.57	150	-22.2	0.078	13	0.19	-45
0.5	0.09	-18	18.4	8.29	143	-21.9	0.081	15	0.19	-53
0.6	0.09	-22	18.1	7.99	136	-21.6	0.084	18	0.20	-62
0.7	0.08	-23	17.7	7.66	130	-21.2	0.087	20	0.20	-71
0.8	0.08	-31	17.4	7.37	124	-20.8	0.091	21	0.20	-80
0.9	0.08	-34	17.0	7.07	118	-20.5	0.095	23	0.20	-87
1.0	0.08	-44	16.6	6.78	112	-20.1	0.099	23	0.19	-94
1.5	0.07	-71	14.8	5.49	88	-18.2	0.123	24	0.19	-125
2.0	0.06	-99	13.3	4.60	68	-16.7	0.146	22	0.17	-145
2.5	0.07	-176	11.9	3.93	50	-15.5	0.167	17	0.18	-174
3.0	0.14	151	10.7	3.42	31	-14.7	0.185	10	0.20	172
3.5	0.20	125	9.5	2.98	15	-14.2	0.196	3	0.24	153
4.0	0.29	106	8.3	2.61	-1	-13.8	0.204	-3	0.28	139
4.5	0.39	96	7.3	2.31	-15	-13.6	0.210	-8	0.32	129
5.0	0.51	90	6.3	2.08	-29	-13.3	0.217	-12	0.36	124
5.5	0.62	83	5.4	1.85	-43	-13.0	0.225	-16	0.40	119
6.0	0.69	75	4.3	1.64	-58	-12.7	0.233	-22	0.47	113



## Tape and Reel Part Number Ordering Information

Part Number	Devices per Reel	Reel Size
MSA-2011-TR1	3000	7"
MSA-2086-TR1	1000	7"

## Outline Drawings

### SOT-143

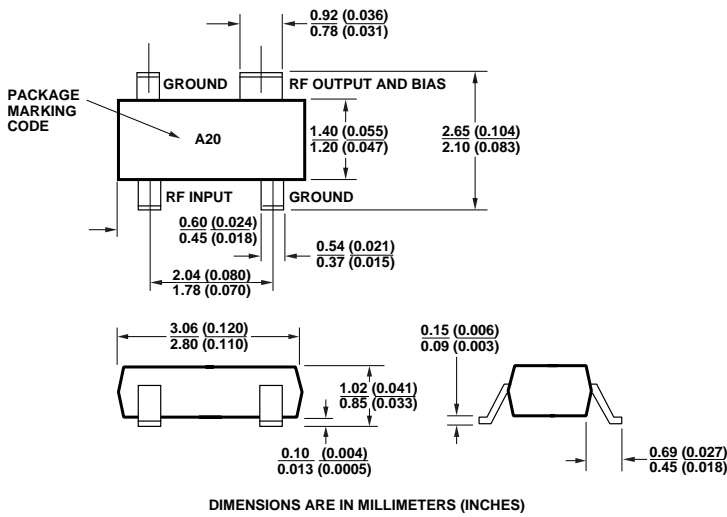

### 35

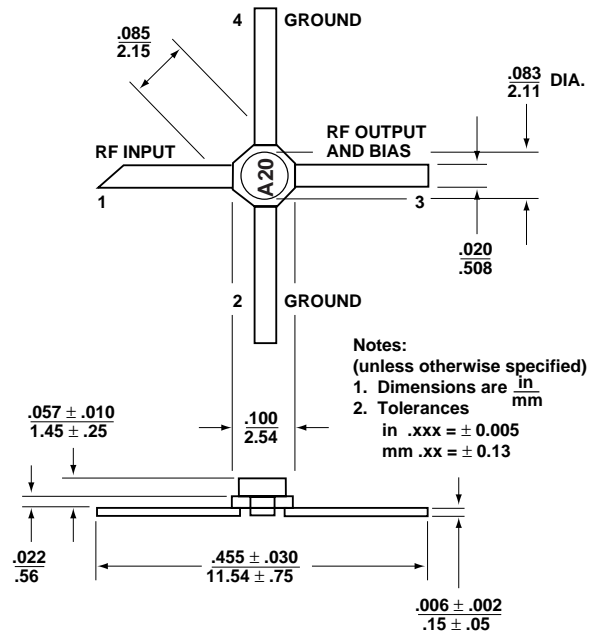

### 85

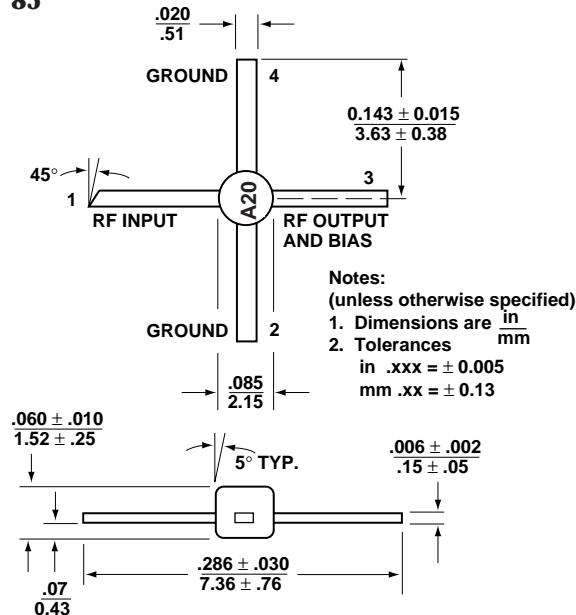

### 86

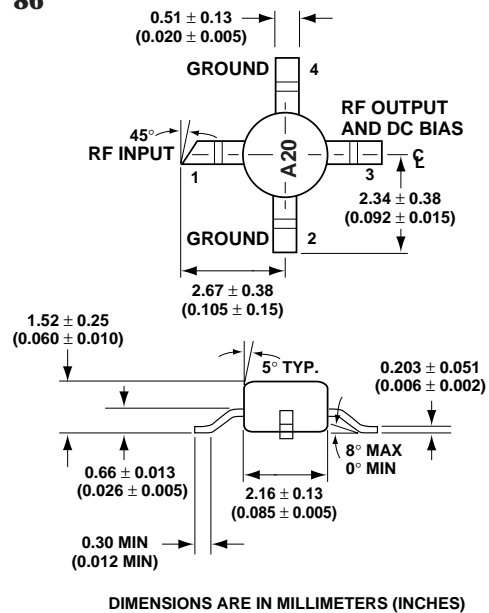

[www.semiconductor.agilent.com](http://www.semiconductor.agilent.com)

Data subject to change.  
 Copyright © 1999 Agilent Technologies  
 Obsoletes 5965-9560E  
 5967-5859E (11/99)