

**MELSEC
AnS,
QnAS**

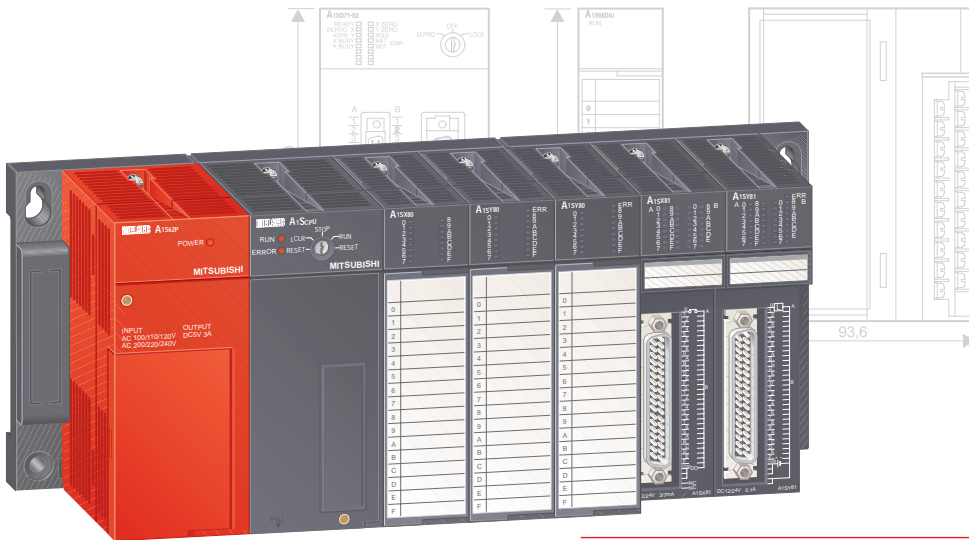
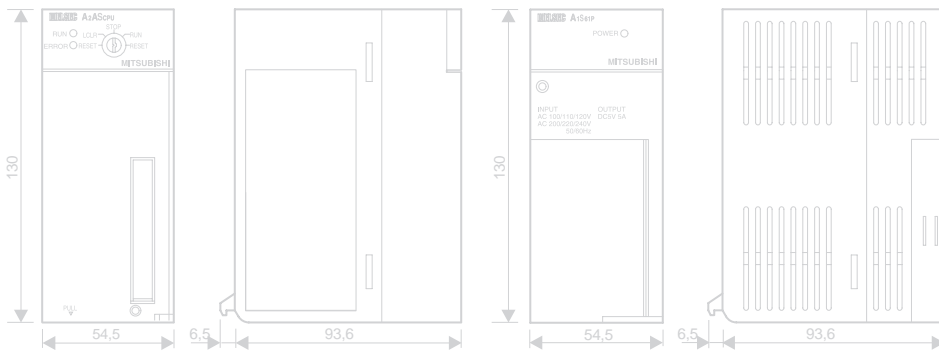

Technical Catalogue

New Items in this Catalogue

New Products
03/00



Basic Components

The SLOT PLC A80BDE-A2USH-S1 adds a MELSEC CPU in the form of a plug-in board for a personal computer to the CPUs of the AnS/QnAS series.



Communications and Special Functions Modules

The line of MELSECNET/10 modules is extended by the floating master module AJ71QLR21 for coaxial connections.

The former MELSECNET/10 interface boards A7BDE-J71LP21 and A7BDE-J71BR11 were replaced by the 4 newly developed boards A70BDE-J71QLP23, A70BDE-J71QLP23GE, A70BDE-J71QLR23, and A70BDE-J71QBR13.

For the AS interface the master module A1SJ71AS92 is provided for the connection between the AnS/QnAS and the AS-I network.



Software

The graphical programming software IDR-BLOK for closed-loop control systems is supplemented by the co-processor module A1SD51S-IDR and the function modules IDR10F-STD and IDR10F-ADV

Further Publications within the PLC Range

Technical
Catalogues



AnU, QnA Series Technical Catalogue

Product catalogue for programmable logic controllers and accessories for the MELSEC A and Q series (art no. 61747)



FX Series Technical Catalogue

Product catalogue for programmable logic controllers and accessories for the MELSEC FX family (art. no. 68544)



HMI Technical Catalogue

Product catalogue for operator terminals, visualisation software and accessories (art. no. 68542)



About this product catalogue

This catalogue is periodically updated due to product range enlargement, technical changes or new or changed features. For actual information about updates, changes, news or even support matters please contact the MITSUBISHI MEL-FAX faxback system (fax: +49 2102 486-485 or -790) or have a look at the MITSUBISHI ELECTRIC web pages under www.mitsubishi-automation.com. Both media are nearly daily updated and available in two languages.

Texts, figures and diagrams shown in this product catalogue are intended exclusively for explanation and assistance in planning and ordering the programmable logic controllers of the MELSEC series and the associated accessories. Only the manuals supplied with the units are relevant for installation, commissioning and handling of the units and the accessories. The information given in this documentation must be read before installation and commissioning of the units or software.

Should questions arise with regard to the planning of devices described in this product catalogue, do not hesitate to contact MITSUBISHI ELECTRIC EUROPE B.V. in Ratingen (Germany) or one of its distributors (see cover page).

No parts of this product catalogue may be duplicated, stored in an information system or transmitted without prior express written permission from MITSUBISHI ELECTRIC EUROPE B.V.

© MITSUBISHI ELECTRIC EUROPE B.V. 03/2000 (7th edition)

MELSEC AnS/QnAS

SYSTEM DESCRIPTION

- ◆ Introduction of the MELSEC AnS series 4
- ◆ Introduction of the MELSEC QnAS series 6
- ◆ Structure and handling 8
- ◆ Networks 10

BASIC COMPONENTS

- ◆ Base units 12
- ◆ Power supply modules 13
- ◆ CPU modules 14

DIGITAL MODULES

- ◆ Input modules 18
- ◆ Output modules 19

SPECIAL FUNCTION MODULES

- ◆ Analog modules, temperature control modules 20
- ◆ Counter, timer and positioning modules 26
- ◆ Interface modules 30
- ◆ Communications modules 33
- ◆ Communications modules for ETHERNET 35
- ◆ Communications modules for MELSECNET/10 38
- ◆ Communications modules for MELSECNET (II) 43
- ◆ Communications modules for MELSECNET/B 46
- ◆ Communications modules for CC-Link 48
- ◆ Communications modules for MELSEC I/O-Link 60
- ◆ Communications modules for PROFIBUS/DP 64
- ◆ Communications modules for DeviceNet 72
- ◆ Communications modules for AS Interface 74
- ◆ Pulse catch and interrupt modules 76

ACCESSORIES

- ◆ Dummy modules 78
- ◆ Cables, converter 79
- ◆ Memory cassettes, adapter units 80
- ◆ Battery, fuses, network accessories 81

TERMINALS AND DIMENSIONS

- ◆ Terminal assignments 83
- ◆ Dimensions 89

PROGRAMMING SYSTEMS

PROGRAMMING

- ◆ Software 92
- ◆ Programming unit, EPROM writer, Cable for programming units 96
- ◆ Teaching Unit 97

APPENDIX

- ◆ Order form 98
- ◆ Index 99

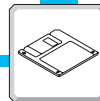
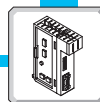
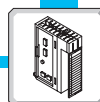
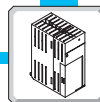

The MELSEC AnS Series

Description

With the MELSEC AnS system, MITSUBISHI ELECTRIC presents its most compact modular PLC, permitting access to the world of network technology.

The small size and the communications capability are two important characteristics of the MELSEC AnS. Its compactness ensures that it occupies less space in the switchgear cabinet and its diverse communication facilities guarantee flexibility and openness. Expandable from 32 to 1024 inputs/outputs, this controller is particularly suitable for performing small to medium automation tasks, very fast automation also being possible with the A2ASCPU.

The individual systems can be installed in a local network (MELSECNET), enabling them to communicate with one another. The number of I/O points can thus be increased several times over.

All CPU types can be combined freely with one another.

The MELSEC AnS is a member of the MELSEC PLC family, which offers compatibility across the range.

Special features

- expandable from 32 to 1024 inputs/output points
- interchangeable intelligence
- diverse communications facilities
- easy installation
- individual adaptation to existing systems
- innovative technology for future applications

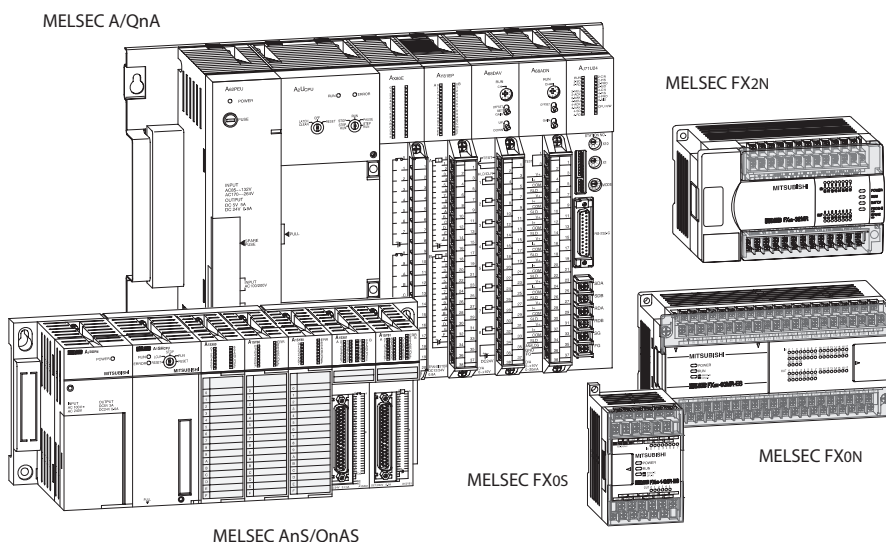

Expandability and performance

In the AnS series, simply changing the CPU ensures that the performance of the PLC grows with the application. Thus, up to 1024 input/output addresses and up to 60 k program memories can be accessed.

The AnS CPUs all have a permanently installed RAM of up to 256 kbyte in which, among other things, the PLC program can be saved. However, EPROM and EEPROM memory cassettes are also available for permanent storage.

In all CPU modules, the memory content is protected by an integrated backup battery. The MELSEC AnS offers tailor-made performance through seven different CPUs:

- **A1SHCPU**, the standard CPU with 256 I/O points and a PLC program memory of 8 k steps
- **A2SHCPU**, the more powerful alternative with 512 I/O points and a PLC program memory of 14 k steps
- **A2SHCPU-S1**, the extended version of the A2SHCPU with 1024 I/O points and a PLC program memory of 30 k steps
- **A2ASCPU**, the most powerful CPU for realizing extremely fast automation tasks with 512 I/O points and a PLC program memory of 14 k steps

- **A2ASCPU-S1, A2ASCPU-S30/-S60** the extended alternative to the A2ASCPU for up to 1024 I/O points and a PLC program memory of 14 k steps for the A2ASCPU-S1 and 30 k or 60 k steps for the A2ASCPU-S30 and A2ASCPU-S60.
- With up to 0.15 μ s per logical instruction, time-critical automation tasks can also be performed. The A2ASCPU-S30 and A2ASCPU-S60 is thus intended for very complex applications.

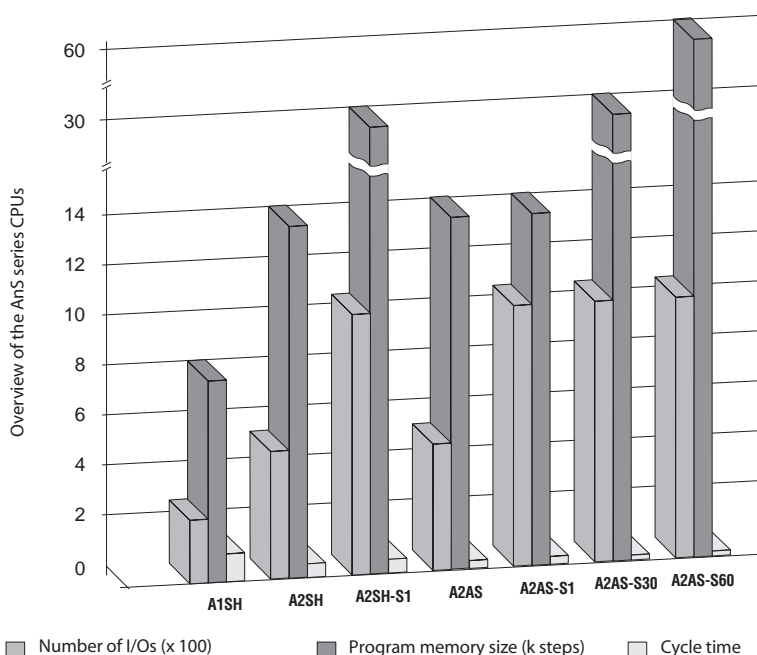

Equipment Features

Owing to the modular concept, the AnS series has a broad range of use with many possible applications. The following modules are available for assembling the system:

To maximize the operational safety, all modules are isolated from the environment by means of optocouplers.

All I/O modules with screw contacts have their own removable terminal blocks which ensures easy handling during installation.

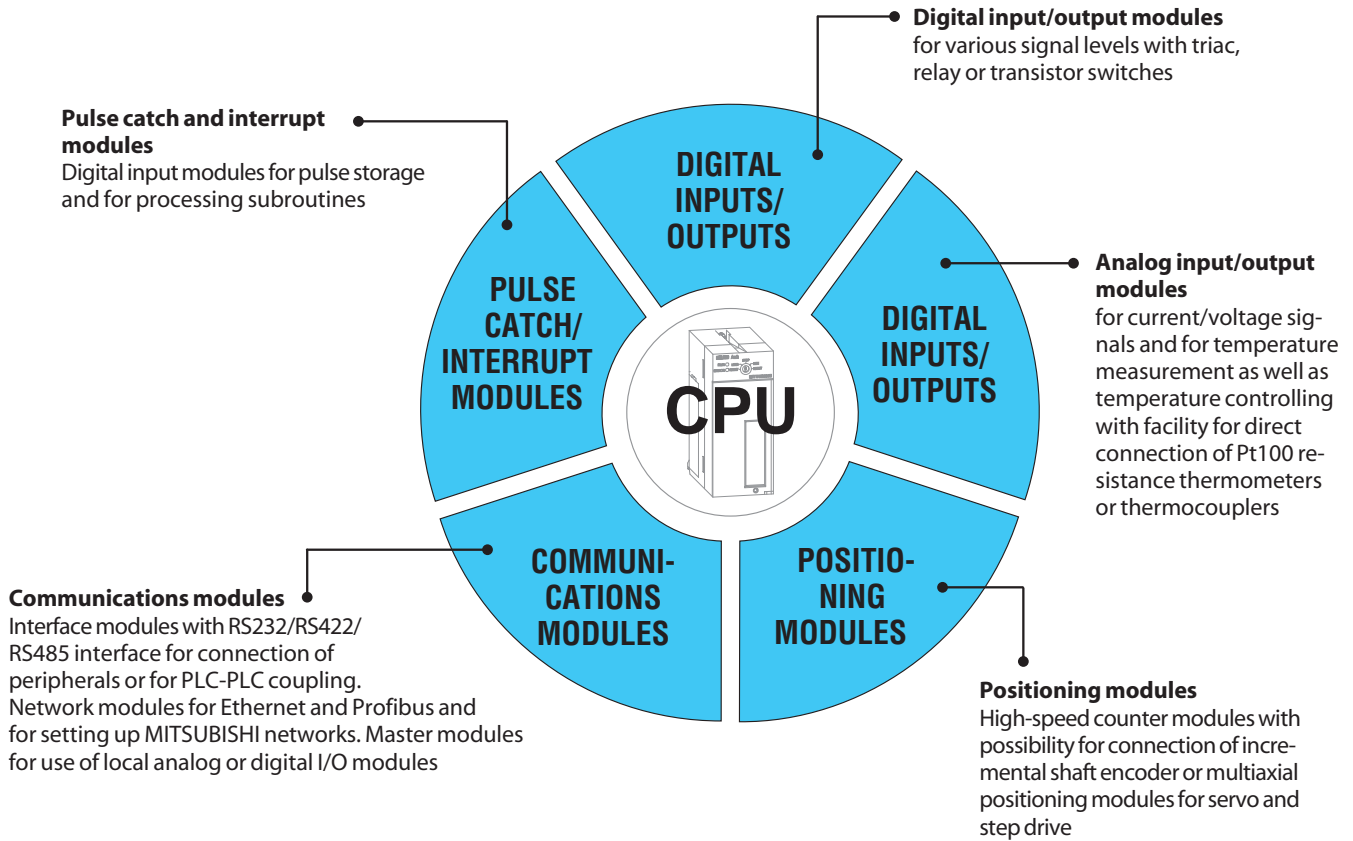

Use of digital and special function modules

The use of digital and analog modules and most special function modules is dependent only on the maximum addressable number of addresses and thus on the CPU used in each case.

With some special function modules, the use within a system is limited. These restrictions also apply to the use of modules of the MELSEC AnU series in the AnS system.

All affected modules are listed in the adjacent table.

Module types		Limitation		
AnS/QnAS series	AnU/QnA series	A1SHCPU, A2SHCPU(-S1)	A2ASCPU(-S1), A2ASCPU-S30/-S60	Q2ASCPU(-S1), Q2ASHCPU(-S1)
A1SJ71UC24-R2 (PRF/R4), A1SJ71E71-B2(-S3), A1SD51S	AD51(-S3), AD51H(-S3), AD57G(-S3), AJ71C22, AJ71C24(-S3/-S6/-S8), AJ71UC24, AJ71E71(-S3)	up to 2 modules per system	up to 6 modules per system	up to 6 modules per system
A1S161	A161(-S1)	only 1 module per system	only 1 module per system	only 1 module per system
A1SJ71AT21B, A1SJ71AR21	AJ71AT21B, AJ71AR21, AJ71AP21	only 1 module per system	up to 2 modules per system *	up to 2 modules per system *
A1SJ71BR11, A1SJ71LP21GE, A1SJ71LP21	AJ71BR11, AJ71LP21GE, AJ71LP21	only 1 module per system	up to 4 modules per system *	not possible
A1SJ71QBR11, A1SJ71QLP21	AJ71QBR11, AJ71QLP21, AJ71QLP21G	not possible	not possible	up to 4 modules per system *
A1SJ71QE71-B2/-B5	AJ71QE71	not possible	not possible	
A1SJ71QC24(-R2)	AJ71QC24	not possible	not possible	no limit

* In this case the total number of modules is limited to 4 (e.g. 2 x AJ71AT21B + 2 x A1SJ71BR11)

The MELSEC QnAS Series

Description

The MELSEC QnAS(H) series is an extremely compact and very powerful new generation of controllers from MITSUBISHI ELECTRIC. Outstanding features include very fast program cycles, ample memory for large amounts of data (approx. 1 mega words) and significantly increased network

access speed. These controllers are ideal for medium-scale applications requiring up to 1024 centralised I/Os in the switch-gear cabinet or up to 8192 remote I/Os.

The QnAS series is also hardware-compatible to the AnS series – this means you can continue to use your modules from this series.

QnAS(H)CPU

Ideal for time-critical applications with execution speeds as fast as 0.075 μ s per logical instruction.

Integrated memory for up to 60 k program steps. Many additional functions are also possible without additional instruction

A1SJ71QBR11, A1SJ71QE71-B2/B5

QnAS series networks support high-speed access to CPU data during the END instruction, bringing a speed increase of up to a factor of 8 compared to conventional systems.

A1S38HB

High-speed base unit that significantly increases the overall performance of the entire system. If high-speed access to the QnAS series CPU via the network is not necessary, a standard base unit can be used.

PCMCIA RAM/EEPROM

One slot for PCMCIA RAM/EEPROM cards

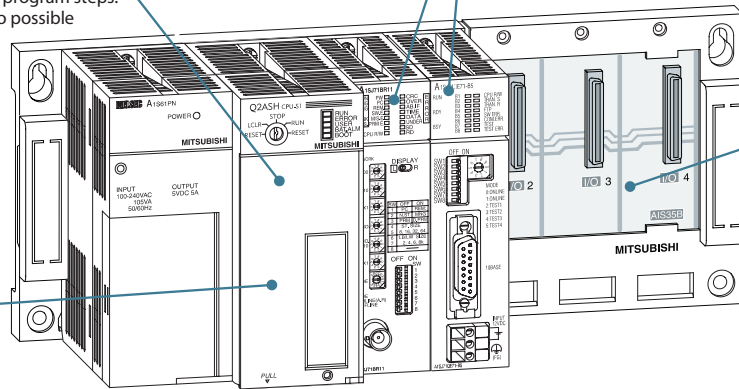

Expansion capability and performance

As with other Mitsubishi controllers the power of the QnAS series grows with your application – you simply replace the CPU. The system can be upgraded to a maximum capacity of 1024 centralised I/Os or 8192 remote I/Os.

The integrated memory of 240 KB RAM can easily be expanded by up to 2 MB at any time just by slotting in a PCMCIA RAM card.

PCMCIA EEPROM cards are also available for permanent storage of your controller programs. An integrated battery protects the data in the CPU's internal RAM against power failures.

The QnAS(H) series includes four different CPU models for tailor-made configurations:

- **Q2ASCPU** 28 k steps program memory, program cycle period 0.15 μ s/logical instruction, 512 I/O points on the system rack.
- **Q2ASCPU-S1** 60 k steps program memory, program cycle period 0.15 μ s/logical instruction, 1024 I/O points on the base unit.

- **Q2ASHCPU** 28 k steps program memory, program cycle period 0.075 μ s/logical instruction, 512 I/O points on the base unit.

- **Q2ASHCPU-S1** 60 k steps program memory, program cycle period 0.075 μ s/logical instruction, 1024 I/O points on the base unit.

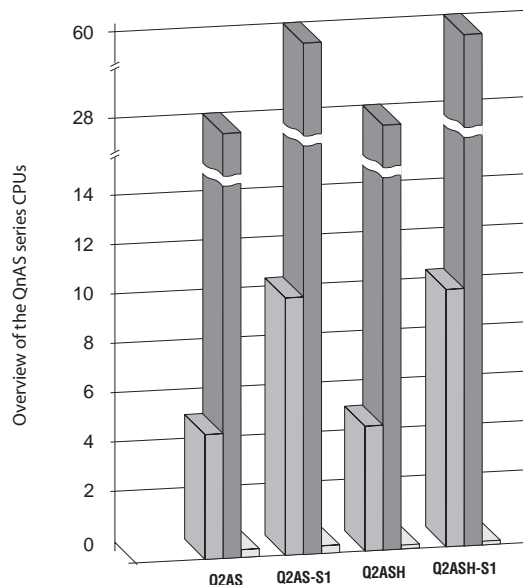

■ Number of I/Os (x 100) □ Cycle time/log. instruction (μ s)
 ■ Program memory size (k steps)

Equipment Features

QnAS highlights

High program execution speed and extremely fast network access were top priorities in the development of this new generation of controllers. At the same time, our engineers also took utmost care to maintain full compatibility to the existing A1S hardware to protect our users investment in their existing systems.

The QnAS CPU's high-speed network access features require the A1S38HB high-speed base unit in combination with the appropriate network card. All conventional I/O modules (both analog and digital) and positioning modules can be used on the high-speed base unit.

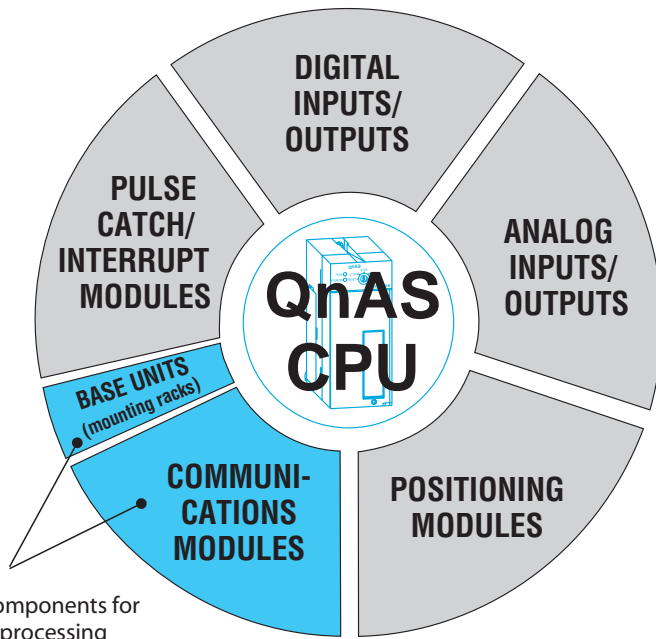

"High-speed" components for high-speed processing

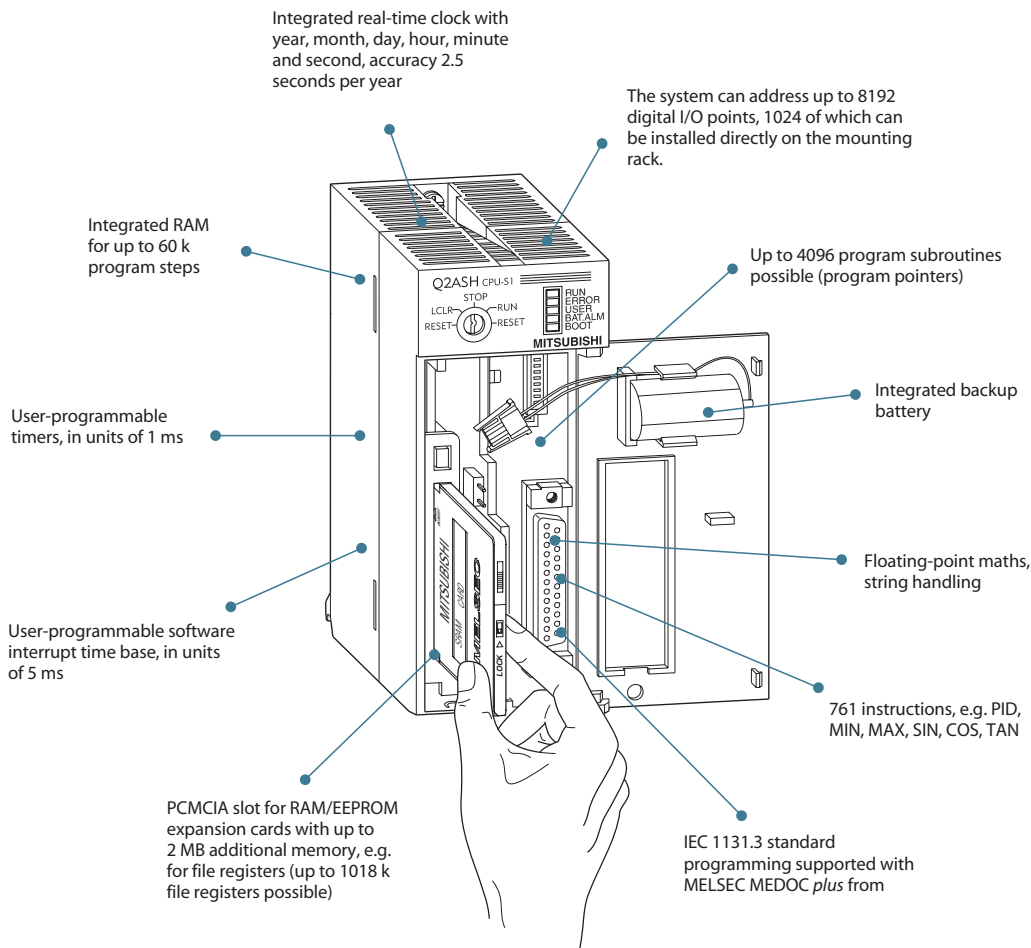

Configuration

System structure

The CPU and modules are held in a base unit which has an internal bus connection for communication between the individual modules and the CPU. The power supply module which supplies the voltage for the entire system is also installed on this base unit.

The main base units are available in 4 different versions with 2 to 8 module slots. Each base unit can be supplemented by means of an extension base unit, providing additional slots.

If you wish to keep open the option of subsequent extension of your PLC or if you have free slots on your main base unit, you can insert dummy modules here. They serve to protect the free slots from soiling or from mechanical effects but can also be used for reserving I/O points.

For cabling larger systems and machines - e.g. in a modular design - the use of remote I/O modules offers additional communications facilities. These modules are connected by means of a shielded two-wire cable.

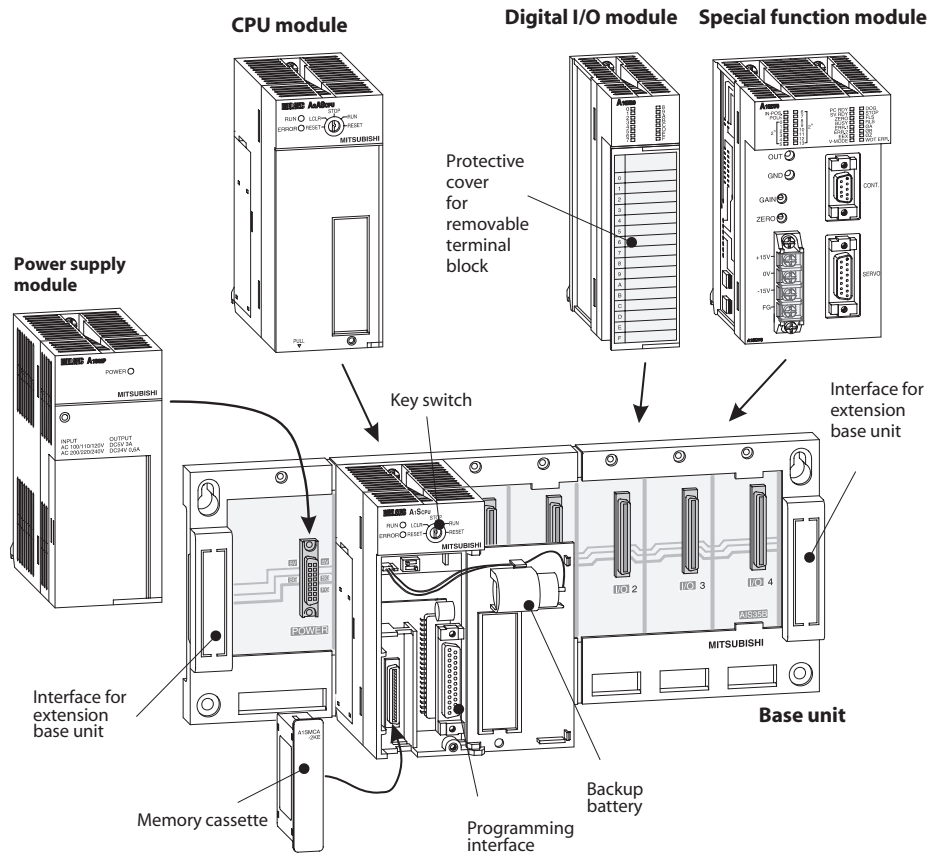

Extension

The main base unit and extension base units are simply connected to one another by extension cables. These connecting cables also supply the extension base units with the operating voltage of 5 V DC.

Up to three extension base units can be connected to a main base unit. The extension may be in the horizontal or vertical direction.

When choosing the power supply module, the total power consumption of the I/O modules, of the special function modules and of the peripherals must be taken into account. If necessary, an extension base unit with a further power supply module should be used.

Base units of the MELSEC AnA/AnU series can also be combined with the AnS series using a special cable.

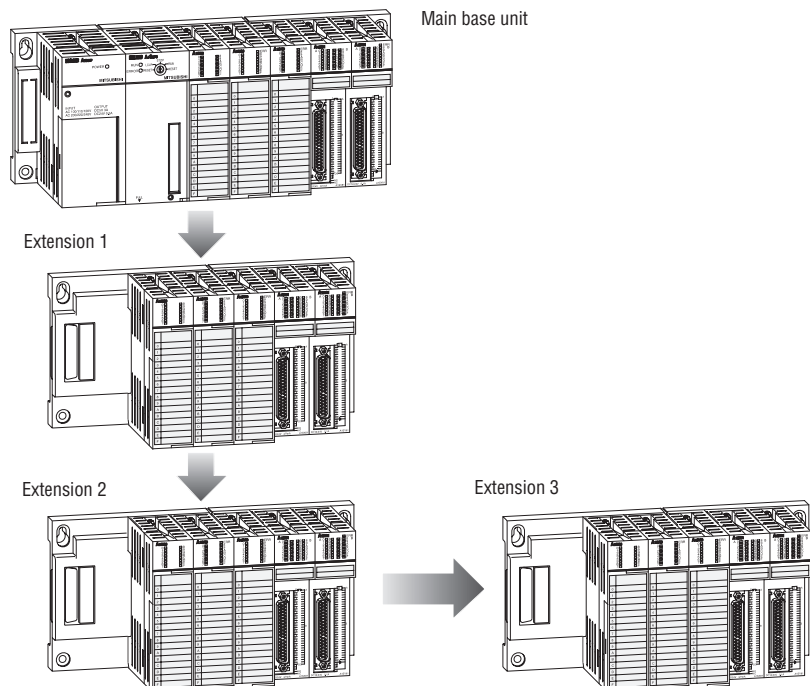

Handling

Mounting the modules

The modules are easily mounted on the main base unit with the aid of a guide lug and a fixing screw. Installation can thus be carried out quickly and without problems.

If it becomes necessary to change an I/O module, the screw terminal block can be removed beforehand. Thus, it is not necessary to disconnect the entire cabling but only 2 screws.

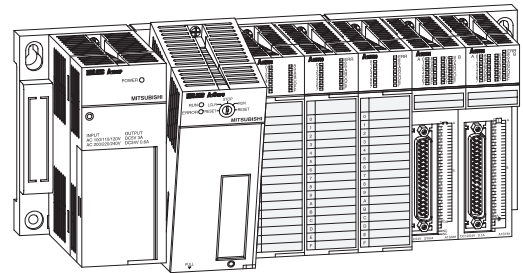
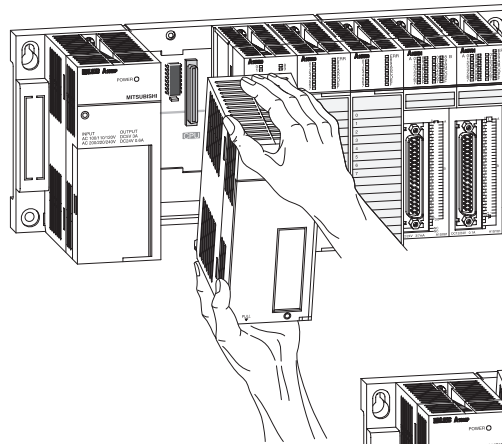

Mounting the base unit

The base unit can be mounted on a DIN rail or by conventional screw attachments.

The individual base units can be mounted either side by side or up to 6 m apart.

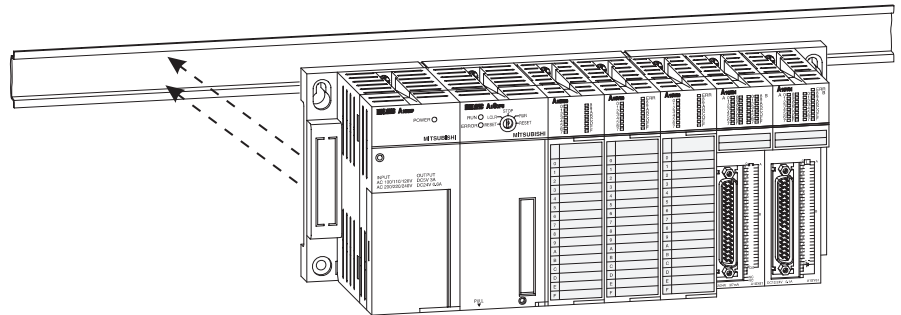

General specifications

General Specifications	Data
Ambient temperature	0 – +55 °C
Storage temperature	-20 – +75 °C
Ambient relative humidity	max. 90 % (non-condensing)
Protection	IP 20
Noise durability	1500 Vpp with noise generator; 1 μs at 25 – 60 Hz
Insulation withstand voltage	AC 1500 V, 1 min.
Shock resistance	10 G (3 times each in 3 directions)
Vibration resistance	2 G: resistant to vibrations from 10 – 55 Hz for 2 hours along all 3 axes; 0,5 G for DIN rail mounting
Insulation resistance	>5 MΩ (500 V DC)
Ground	Class 3
Environment	Avoid environments containing corrosive gases, install in a dust-free location.
Certifications ^①	UL / CSA / CE / DNV / RINA / LR

^① Approvals for MELSEC AnS series and CE certifications for MELSEC QnAS series as described on the following pages.



MELSEC Networks

TCP/IP ETHERNET

Ready for immediate operation with the worldwide standard TCP/IP protocol. A PC connected to the Ethernet has full access to all PLCs in the MELSECNET, all the way down to the I/Os on the production level.

MELSECNET/10 und -NET(II)

Low-cost cabling, brilliantly simple set-up and maximum availability thanks to redundancy and Floating Master. The maximum coverage is up to 30 km.

COMMAND LEVEL

TCP/IP ETHERNET

CONTROL LEVEL

MELSECNET/10
MELSECNET(II)
MELSECNET/B

PRODUCTION LEVEL

CC-Link
MELSEC I/O-LINK
MELSEC FX-PPN

MELSECNET/B

A cost-effective alternative within the production level. Enables implementation of easily-manageable configurations for complex applications by means of distributed intelligence.

CC-Link

The network for the control and I/O level comprises capabilities like real-time processing and distributed intelligence. Modules of third party manufacturers can be integrated.

MELSEC I/O-LINK

Remote module distribution to the machine. Devices of third party manufacturers can be integrated. Cabling with twisted pair cable in a tree structure.

MELSEC FX Peer-to-Peer

The PPN construction enables a network for up to 8 FX2N and FX0N controllers as clients.

The max. coverage is up to 500 m. A standard twisted-pair cable can be used as the communications media.

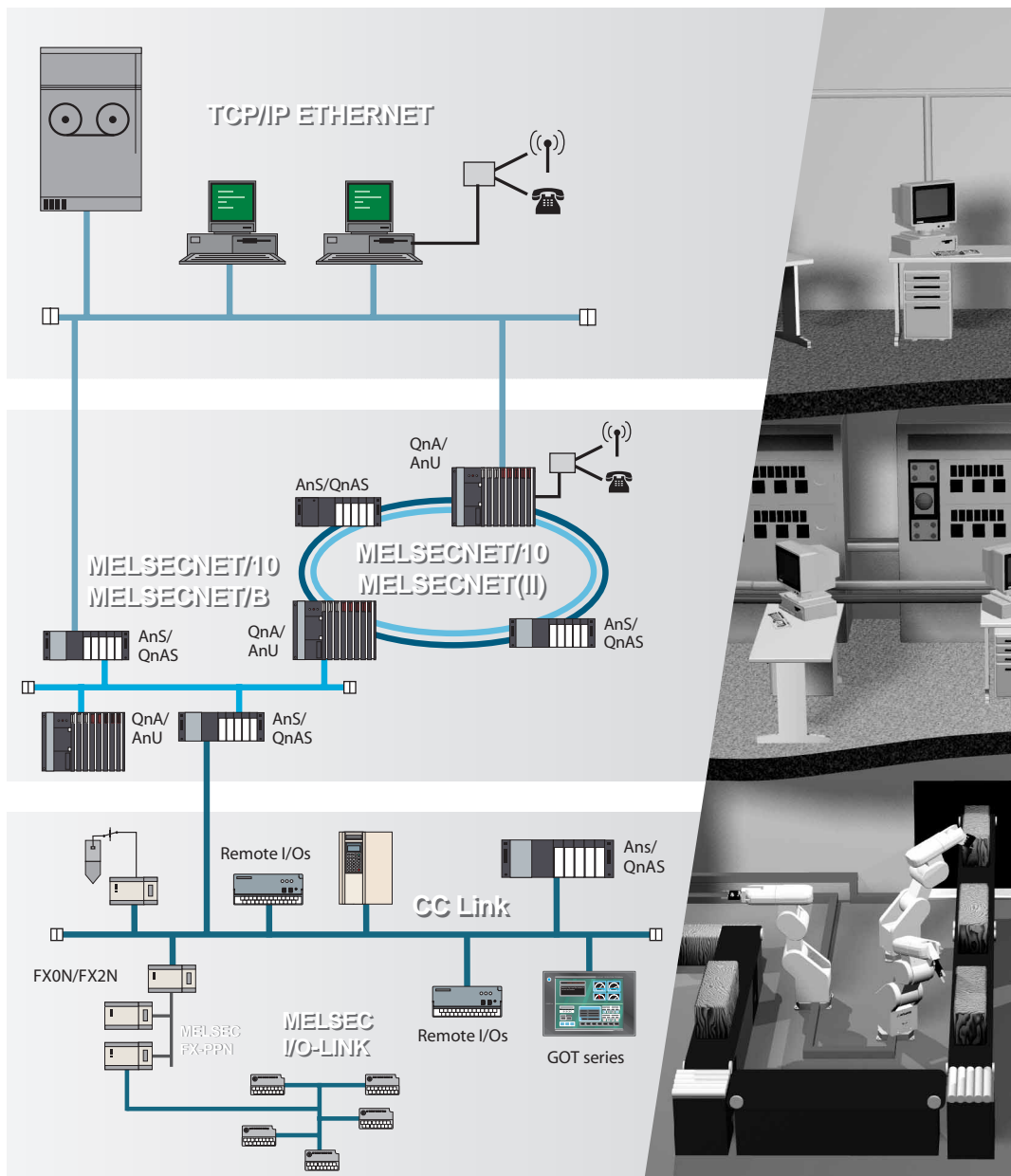

Open Networks

MAP 3.0 ETHERNET

Interdepartmental data exchange between the command and production levels using a non-proprietary protocol with short throughput times.

Profibus FMS

Communication between equipment from different manufacturers within a single plant. Automatic data exchange with MELSEC networks.

Profibus DP

Enables quick and simple connection of sensors and actuators from different manufacturers to MELSEC PLCs, with data transfer rates of up to 12 Mbaud.

DeviceNet

Cost-effective CAN-based network communications. Fault-resistant network structure where components of different manufacturers can be integrated quickly and easily.

AS Interface

International standard for the lowest field bus level. Connection of conventional sensors and actuators with twisted pair cable.

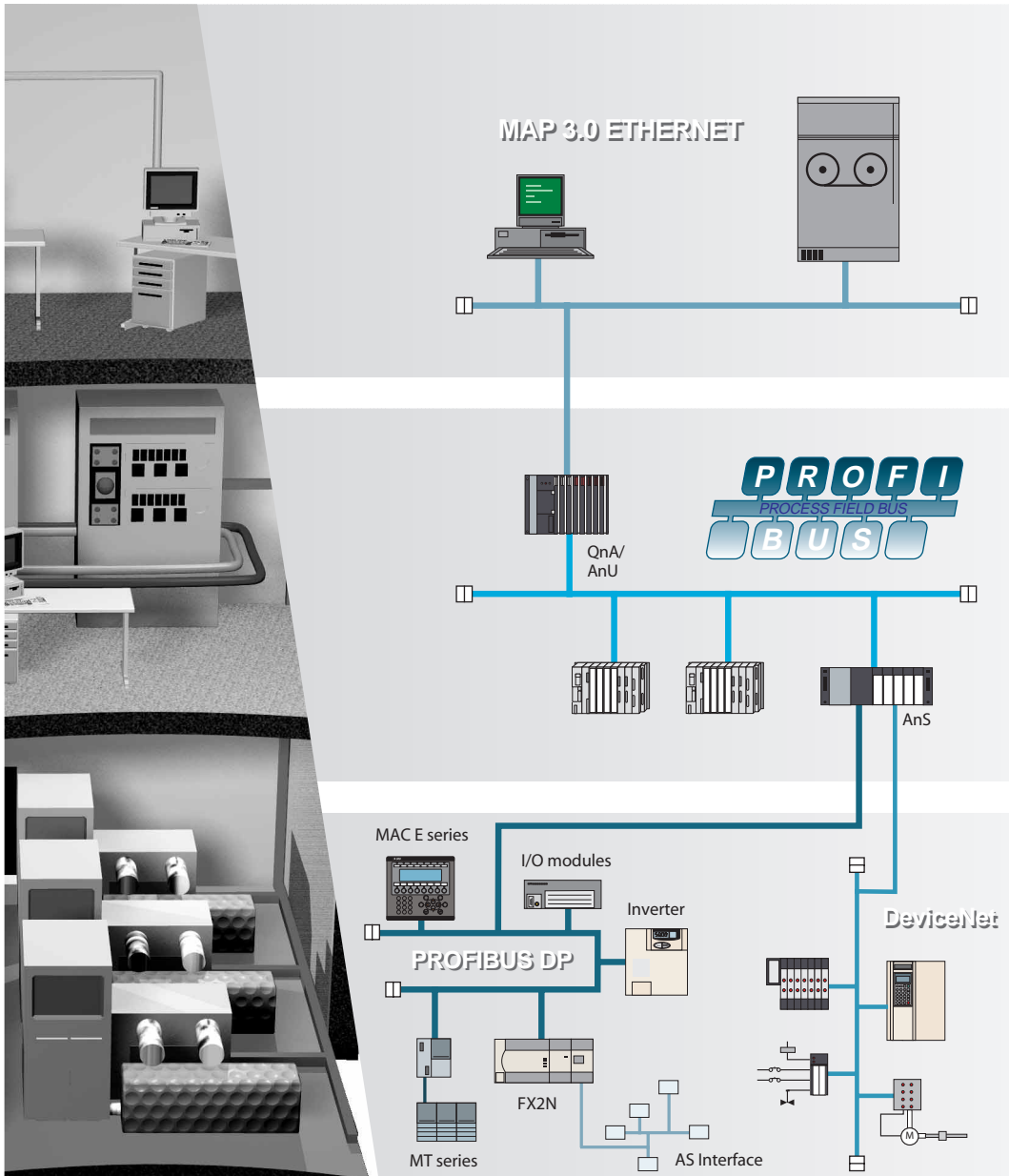

COMMAND LEVEL
MAP 3.0 ETHERNET

CONTROL LEVEL
Profibus FMS

PRODUCTION LEVEL
Profibus DP
DeviceNet
AS Interface



■ MELSEC AnS/QnAS Main Base Units

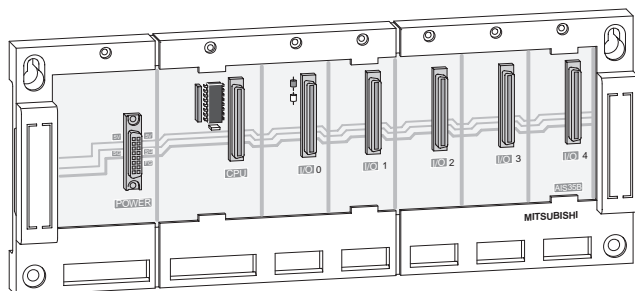

The main base unit is used for holding and coupling CPU, power supply unit, input modules, output modules and special function modules.

Special features:

- The modules are automatically addressed. In general, it is assumed that base units with 8 slots will be used. Dummy slots or missing slots (in the case of base units with less than 8 slots) are assigned to 16 addresses. The automatic addressing can be changed by means of the function "I/O assignment".
- The units are mounted by means of screws or on a profiled rail with an integrated adapter.

Specifications	A1S32B-E	A1S33B-E	A1S35B-E	A1S38B-E	A1S38HB-EU	
I/O modules	2	3	5	8	8	
Installation	All base units possess an installation hole $\varnothing 6$ mm and M5 screws. *					
Weight	kg	0.52	0.65	0.75	0.97	1.0
Dimensions (W x H x D)	mm	220 x 130 x 28	255 x 130 x 28	325 x 130 x 28	430 x 130 x 28	430 x 130 x 28
Order information	Art. no.	48370	48371	48372	48373	69663

* An adapter is integrated for mounting on a DIN rail.

■ MELSEC AnS/QnAS Extension Base Units

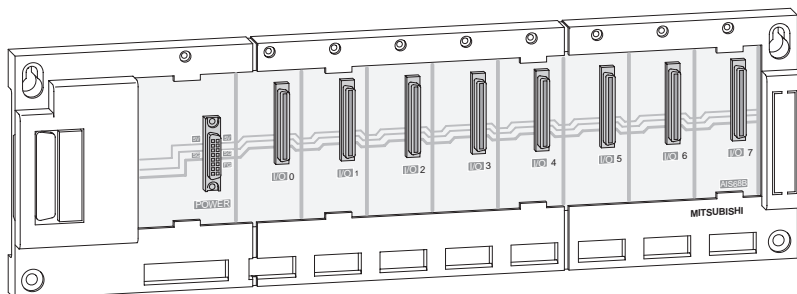

The extension base units are connected to the main base unit by means of assembled bus cables. Thus, an AnS/QnAS system can be expanded to 32 I/O modules. Extension base units with or without their own power supply module are available.

Special features:

- A total of three extension base units can be connected to a main base unit.
- The maximum distance from the first to the last base unit is 6 m.

An extension base unit with a power supply module must be used in the following cases:

- If the power consumption of the inserted modules exceeds the capacity of the power supply module on the main base unit.
- If the voltage drops below 4.75 V between the main base unit and the extension base unit.

Specifications	A1S52B-S1	A1S55B-S1	A1S58B-S1	A1S65B-S1	A1S68B-S1	
Power supply modules	—	—	—	1	1	
I/O modules	2	5	8	5	8	
Installation	All base units possess an installation hole $\varnothing 6$ mm and M5 screws. *					
Weight	kg	0.38	0.61	0.87	0.71	0.95
Dimensions (W x H x D)	mm	155 x 130 x 28	260 x 130 x 28	365 x 130 x 28	315 x 130 x 28	420 x 130 x 28
Order information	Art. no.	39667	38073	38072	38071	38070
Accessories	Connection cables (refer to page 79)					

* An adapter is integrated for mounting on a DIN rail.

MELSEC AnS/QnAS Power Supply Modules

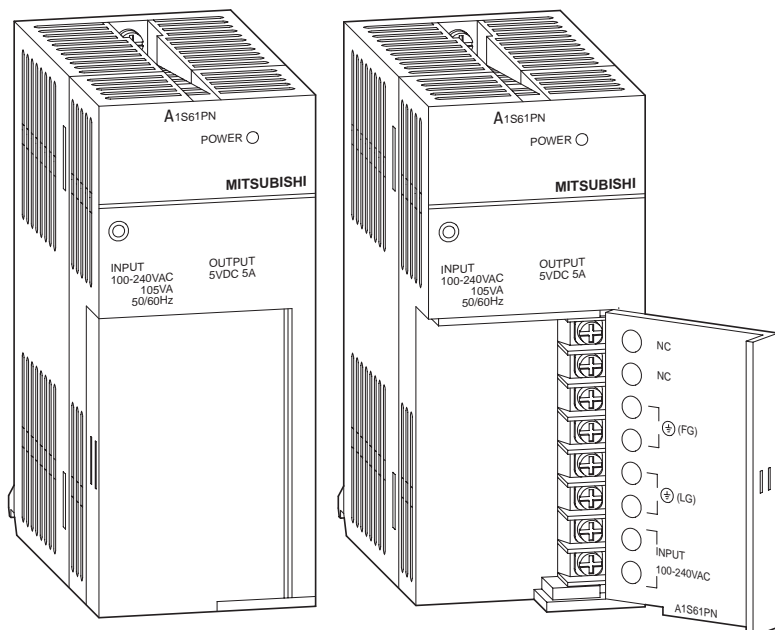

Power supply modules

They supply the individual modules with the voltages required for operation. The choice is dependent on the power consumption of the individual modules.

Special features:

- The readiness for operation is indicated by a red LED.
- For example, controllers can be supplied by means of additional 24 V DC output (A1S62PN).
- The power supply modules A1S61PN and A1S62PN can be used world wide because they support the wide input range from 100 to 240 V AC at 50/60 Hz.

Specifications	A1S61PN	A1S62PN	A1S63P
Input voltage	(+10%, -15%) V AC	100 – 240	—
	(+30%, -35%) V DC	—	24
Input frequency	Hz	50 / 60 (±5 %)	—
Inrush current		20 A within 8 ms	81 A within 8 ms
Max. input apparent power		105 VA	41 W
Rated output current	5 V DC	A	5
	24 V DC ±10 %	A	—
Overcurrent protection	5 V DC	A	≥ 5.5
	24 V DC	A	—
Overvoltage protection	5 V DC	V	5.5 – 6.5
	24 V DC	V	—
Efficiency		≥ 65 %	≥ 65 %
Insulation withstand voltage	between primary and 5 V DC	2830 V AC, 1 min.	500 V AC, 1 min.
	between primary and 24 V DC	—	2830 V AC, 1 min.
Max. compensation time at power failure	ms	20	1
Power indicator	All modules possess a power LED display.		
Terminal screw size	All modules possess terminal screw size M 3.5 x 7.		
Applicable wire size	AWG 18 – 14	AWG 18 – 14	AWG 16 – 22
Weight	kg	0.8	0.5
Dimensions (W x H x D)	mm	54.5 x 130 x 93.6	54.5 x 130 x 93.6
Order information	Art.no.	65051	65052
			29536

MELSEC AnS CPU Modules

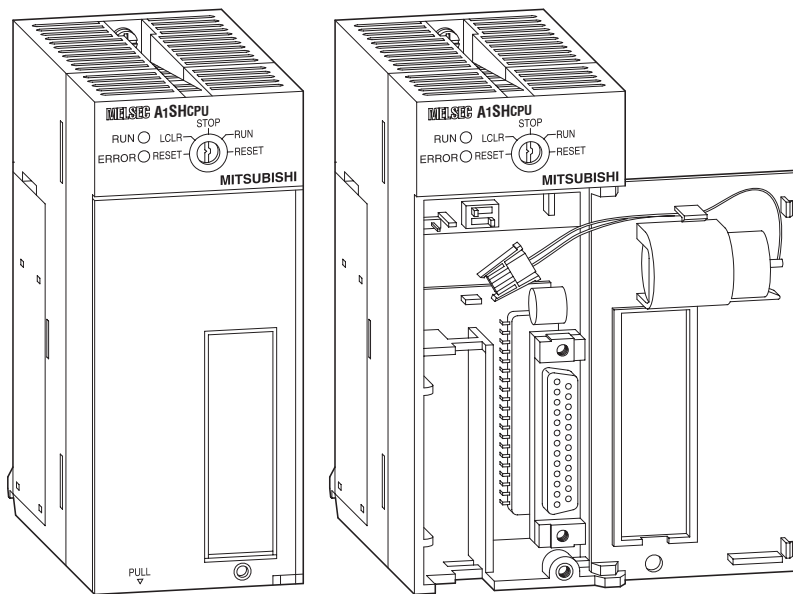

A1SHCPU, A2SHCPU(-S1)

7 different CPUs with graded performance are available for the MELSEC AnS. All versions are upwardly compatible. Thus, the MELSEC AnS can grow with the application if the CPU is changed.

Special features:

- Integrated RAM as standard feature for storing the PLC program and data
- Integrated backup battery for backing up the RAM and definable PLC operands
- Nonvolatile EPROM and EEPROM memories can be inserted as options
- Integrated programming interface in the form of a differential interface (RS422)
- Processing of the inputs and outputs in direct mode or as refresh mode

Specifications	A1SHCPU	A2SHCPU	A2SHCPU-S1
I/O points (internal)	256	512	1024
Total I/O points (with remote I/O units)	2048	2048	2048
CPU self-diagnostic functions	CPU error detection, Watch Dog, battery error detection, memory error detection, program check, power supply error detection, fuse error detection		
Battery buffer	All modules are fitted with a lithium-battery with a life expectancy of 5 years.		
Memory type	RAM, EPROM, EEPROM	RAM, EPROM, EEPROM	RAM, EPROM, EEPROM
Program capacity ^①	overall kByte	64	192
	max. for PLC program	8 k steps	30 k steps
	max. for internal microcomputer program kByte	14	30
Cycle time	0.333 μ s/log. instruction	0.25 μ s/log. instruction	0.25 μ s/log. instruction
Timer (T)	256	256	256
Counter (C)	256	256	256
Internal / special relay (M)	2048 / 256	2048 / 256	2048 / 256
Data register / special register (D)	1024 / 256	1024 / 256	1024 / 256
File register (R) ^②	Max. 8192	Max. 8192	Max. 8192
Interrupt pointer (I)	32	32	32
Pointer (P)	256	256	256
Annunciator (F)	256	256	256
Accumulator (A)	2	2	2
Index register (V, Z)	2	2	2
Link relay (B) / link register (W)	1024 / 1024	1024 / 1024	1024 / 1024
Comments ^②	Max. 4032	Max. 4032	Max. 4032
Instructions	261	261	261
Internal power consumption (5V DC) mA	300	400	400
Max. compensation time at power failure ms	20	20	20
Weight kg	0.33	0.33	0.33
Dimensions (W x H x D) mm	54.5 x 130 x 93.6	54.5 x 130 x 93.6	54.5 x 130 x 93.6
Order information	Art. no. 66612	66613	66611
Accessories	Memory cassettes (refer to page 78)		

^① Dependent on one another

^② Number dependent on the memory configuration

MELSEC AnS CPU Modules

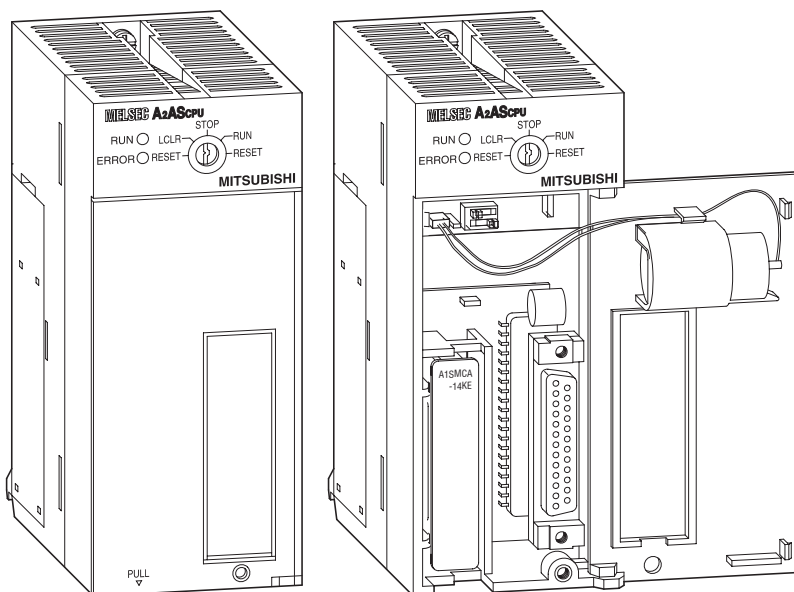

A2ASCPU(-S1), A2ASCPU-S30/-S60

In performance, the CPU types A2AS(-S1) correspond to the A1S/A2S(-S1) types. The A2ASCPU-S30/-S60 dispose of more program capacity and shorter cycle time. The AnAS types are also particularly suitable for applications where short PLC cycle times are required.

Special features:

- Processing the inputs and outputs with refresh mode
- Floating point arithmetic according to IEEE 754
- Special statements for processing PID control loops
- Mathematical functions, such as angle/exponential functions and logarithm

Specifications	A2ASCPU	A2ASCPU-S1	A2ASCPU-S30	A2ASCPU-S60
I/O points	512	1024	1024	1024
CPU self-diagnostic functions	CPU error detection, Watch Dog, battery error detection, memory error detection, program check, power supply error detection, fuse error detection			
Battery buffer	All modules are fitted with a lithium-battery with a life expectancy of 5 years.			
Memory type	RAM, EPROM, EEPROM	RAM, EPROM, EEPROM	RAM, EPROM, EEPROM	RAM, EPROM, EEPROM
Program capacity ①	overall kByte	64	256	256
	max. for PLC program	14 k steps	14 k steps	60 k steps
Cycle time	0.2 μs/log. instruction	0.2 μs/log. instruction	0.15 μs/log. instruction	0.15 μs/log. instruction
Timer (T)	2048	2048	2048	2048
Counter (C)	1024	1024	1024	1024
Internal / special relay (M)	8192 / 256	8192 / 256	8192 / 256	8192 / 256
Data register / special register (D)	6144 / 256	6144 / 256	6144 / 256	6144 / 256
File register (R) ②	Max. 8192	Max. 8192	Max. 8192	Max. 8192
Interrupt pointer (I)	32	32	32	32
Pointer (P)	256	256	256	256
Annunciator (F)	2 048	2 048	2 048	2 048
Accumulator (A)	2	2	2	2
Index register (V, Z)	14	14	14	14
Link relay (B) / link register (W)	4096 / 4096	4096 / 4096	4096 / 4096	4096 / 4096
Comments / expanded comments ②	Max. 4032 / max. 3968	Max. 4032 / max. 3968	Max. 4032 / max. 3968	Max. 4032 / max. 3968
Instructions	463	463	463	463
Internal power consumption (5 V DC)	320 mA	320	320	320
Max. compensation time at power failure	20 ms	20	20	20
Weight	0.41 kg	0.41	0.41	0.41
Dimensions (W x H x D)	54.5 x 130 x 93.6 mm	54.5 x 130 x 93.6	54.5 x 130 x 93.6	54.5 x 130 x 93.6
Order information	Art. no. 38067	42615	56084	63884
Accessories	Memory cassettes (refer to page 80)			

① Independent

② Number depends on memory configuration

■ MELSEC QnAS CPU Modules

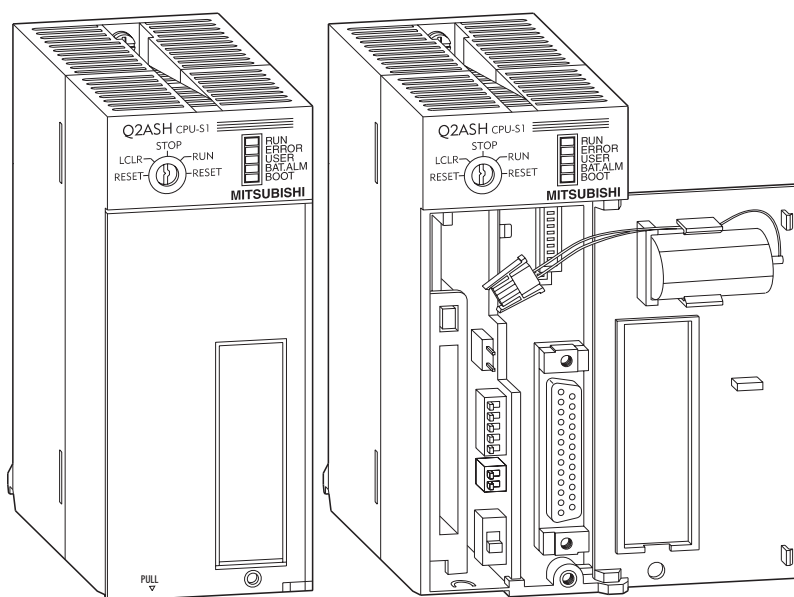

Q2ASCPU(-S1), Q2ASHCPU(-S1)

These controllers make it possible to use small modular systems in complex production systems calling for short cycle times. These CPUs can also handle really large recipes, making them ideal for use in networks.

Special features:

- Processing of inputs and outputs as process I/O image (direct processing instructions are available)
- IEEE 754 floating point maths
- Dedicated instructions for PID controller circuits
- Mathematical functions including trig, exponents and logarithms
- The CPU can store an entire controller cycle program including the graphical information. This means that the entire program information is available when you download the program from the CPU to the PC.

Specifications	Q2ASCPU	Q2ASCPU-S1	Q2ASHCPU	Q2ASHCPU-S1
Max. I/O points overall	8192	8192	8192	8192
Max. I/O points on mounting rack	512	1024	512	1024
CPU self-diagnostic functions	Program plausibility, watchdog (time), battery check, memory test, CPU test, line voltage monitor, fuse test			
Battery buffer	All modules are fitted with a lithium-battery with a life expectancy of 5 years.			
Memory type	RAM, EEPROM	RAM, EEPROM	RAM, EEPROM	RAM, EEPROM
Program capacity ^①	overall kByte	112	240	112
	max. for PLC program	28 k steps	60 k steps	28 k steps
Cycle period	LD: 0.20 / MOV: 0.60			
Timers (T)	2048	2048	2048	2048
Counters (C)	1024	1024	1024	1024
Relays / special relays (M)	8192 / 2048	8192 / 2048	8192 / 2048	8192 / 2048
Data registers / special registers (D)	12288 / 2048	12288 / 2048	12288 / 2048	12288 / 2048
File registers (R) ^②	1018 k words x 1 (PCMCIA memory card required. Number of file registers depends on capacity of PCMCIA memory card.)			
Interrupt pointer (I)	48	48	48	48
Pointer (P)	4096	4096	4096	4096
Annunciator (F)	2048	2048	2048	2048
Index register (Z)	16	16	16	16
Link relay (B) / link register (W)	8192 / 8192	8192 / 8192	8192 / 8192	8192 / 8192
Comments ^②	Approx. 64 k (PCMCIA memory card required. Number of comments depends on capacity of PCMCIA memory card.)			
Instructions	Sequential: 39, others: 722	Sequential: 39, others: 722	Sequential: 39, others: 722	Sequential: 39, others: 722
Internal power consumption (5 V DC)	300 mA	300	700	700
Max. compensation time at power failure	ms Depends on power supply unit used, see page 13.			
Weight	0.5 kg	0.5	0.5	0.5
Dimensions (W x H x D)	54.5 x 130 x 110 mm	54.5 x 130 x 110	54.5 x 130 x 110	54.5 x 130 x 110
Order information	Art. no.	61039	61031	61044
Accessories	Memory cards (refer to page 80)			

① Interdependent

② Number depends on memory configuration

MELSEC Slot PLC

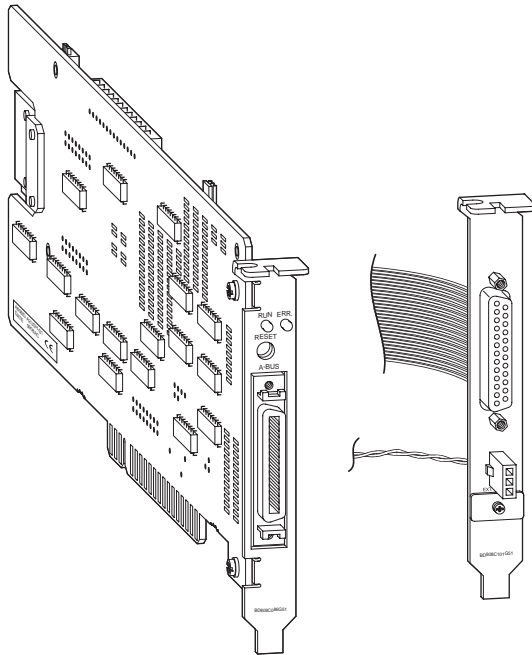

PLC based controller

The slot PLC A80BDE-A2USH-S1 is a MELSEC CPU in the form of a PC slot-in board and is designed for the installation in a PC with the operating system MS Window NT (from version 4.0)

Special features:

- 32 bit PCI board with 33 MHz bus clock rate
- Extension units with modules of the AnU/AnS series can be connected
- Installation software included when shipped
- Programmable by MELSEC MEDOC *plus* and GPP/Win
- Access to devices of the CPU with the help of the programming languages Visual C++ or Visual Basic (from version 5)
- Extensive software package (see accessories in the table below)

Specifications		A80BDE-A2USH-S1
Max. I/O points		8192 total / 1024 on base unit (192 I/O points 00-BF used by the system)
CPU self-diagnostic functions		Program plausibility, Watch Dog (time), battery check, memory error detection, CPU error detection, power supply error detection, fuse test
Backup battery		The board is equipped with a lithium-battery with a durability of 5 years.
Memory type		RAM, EPROM
Program capacity ^①	overall	kBytes 448
	max. for PLC program	30 k steps
Cycle time		0.09 μs/log. instruction
Timer (T)		2048
Counter (C)		1024
Internal relay / special relay (M)		8192 / 256
Data register / special register (D)		8192 / 256
File register (R) ^②		Max. 8192
Interrupt pointer (I)		32
Pointer (P)		256
Annunciator (F)		2048
Accumulator (A)		2
Index register (V, Z)		14
Link relay (B) / link register (W)		8192 / 8192
Comments ^②		Max. 4032
Instructions		462
Internal current consumption	A	Max. 2
External voltage supply		+5 V DC (+-5%)
Weight	kg	0.5
Dimension		Standard PCI board
Order information	Art. no.	129404
Accessories		Base driver software for CPU-PC communications: SW3D5F-CSKP-E, software tool for simple data exchange between CPU and MS-EXCEL: SW3D5F-OLEX-E, user programmable visualization package: SW3D5F-XMOP-E, memory cassette art. no.: 24706, 24746, 4103

① Dependent on one another
 ② Number dependent on the memory configuration



MELSEC AnS/QnAS Digital Input Modules

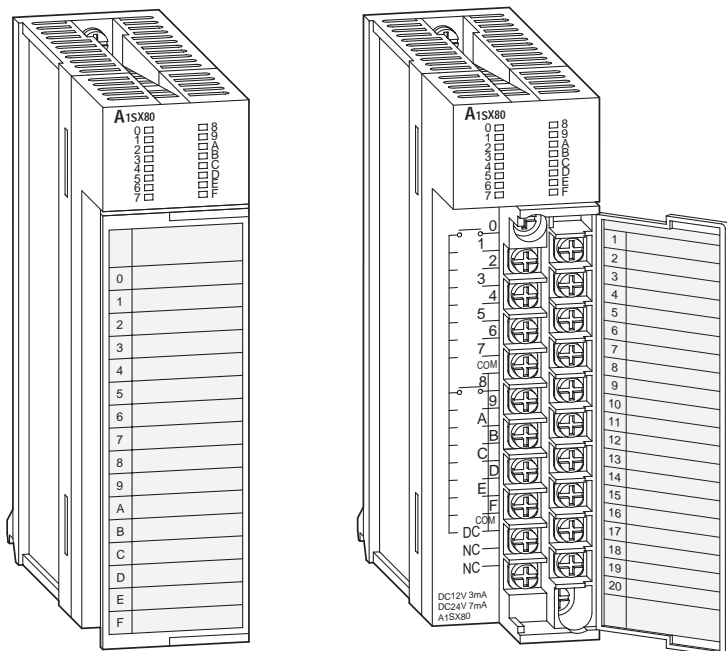

Detection of process signals

Various input modules are available for converting the digital process signals with different voltage levels into the levels required by the PLC.

Special features:

- The input points can be operated alternatively as positive or negative switching.
- Potential isolation between process and control by means of an optocoupler is a standard feature
- Indication of input status via LEDs
- Modules with 16 connection points have removable terminal blocks with screws.
- Modules with 32 connection points have a 37-pin D-sub plug (supplied with the module)
- Assembled cables are available for modules with D-sub plugs (A32CBL: 3 m).

Specifications	A1SX10EU	A1SX20EU	A1SX80	A1SX80-S1	A1SX81
Input points	16	16	16	16	32
Isolation method	Photocoupler isolation between input terminals and PC power for all modules.				
Rated input voltage	110 – 120 V AC (50 / 60 Hz)	200 – 240 V AC (50 / 60 Hz)	12 / 24 V DC	24 V DC	12 / 24 V DC
Operating voltage range	AC 85 – 132 V AC	170 – 264 V AC	—	—	—
Max. simultaneously ON	100 %	60 % (at 220 V AC)	100 % (at 26.4 V DC)	100 % (at 26.4 V DC)	60 % (at 26.4 V DC)
Inrush current	200 mA for 1 ms (at 132 V AC)	500 mA for 1 ms (at AC 264 V)	—	—	—
Rated input current	mA 7 mA (at 120 V AC, 60 Hz)	ca. 11 (at 240 V AC, 60 Hz)	ca. 3 / ca. 7	ca. 7	ca. 3 / ca. 7
ON	voltage V \geq AC 80	\geq AC 80	\geq DC 8	\geq DC 17	\geq DC 8
	current mA \geq AC 5	\geq AC 4	\geq DC 2	\geq DC 5	\geq DC 2
OFF	voltage V \leq AC 30	\leq AC 30	\leq DC 4	\leq DC 5	\leq DC 4
	current mA \leq AC 1	\leq AC 1	\leq DC 1	\leq DC 1.7	\leq DC 1
Load resistance	k Ω ca. 21 (50 Hz) / ca. 18 (60 Hz)	ca. 27 (50 Hz) / ca. 22 (60 Hz)	ca. 3.3	ca. 3.3	ca. 3.3
Response time	OFF \rightarrow ON ms \leq 20 (100 V AC, 60 Hz)	\leq 30 (200 V AC, 60 Hz)	\leq 10 (24 V DC)	\leq 0,4 (24 V DC)	\leq 10 (12 / 24 V DC)
	ON \rightarrow OFF ms \leq 35 (100 V AC, 60 Hz)	\leq 55 (200 V AC, 60 Hz)	\leq 10 (24 V DC)	\leq 0,5 (24 V DC)	\leq 10 (12 / 24 V DC)
Common terminal arrangement	16	16	16	16	32
Power indicator	All modules possess a status LED per input/output.				
Connection terminal	20-point removable terminal block	20-point removable terminal block	20-point removable terminal block	20-point removable terminal block	Compact plug type 37 D-Sub
No. of occupied I/O points	16	16	16	16	32
Applicable wire size	mm ² 0.75 – 1.5	0.75 – 1.5	0.75 – 1.5	0.75 – 1.5	0.3
Internal power consumption (5 V DC)	mA 50 (all input points ON)	50 (all input points ON)	50 (all input points ON)	50 (all input points ON)	80 (all input points ON)
Weight	kg 0.21	0.23	0.2	0.2	0.24
Dimensions (W x H x D)	mm 34.5 x 130 x 93.6	34.5 x 130 x 93.6	34.5 x 130 x 93.6	34.5 x 130 x 93.6	34.5 x 130 x 93.6
Order information	Art. no. 54914	53665	24973	31536	24974
Accessories	—	—	—	—	Adapter cable (see page 77)
Spare parts	20-point removable terminal block and cover: A1STEC-S, art. no. 31248				

MELSEC AnS/QnAS Digital Output Modules

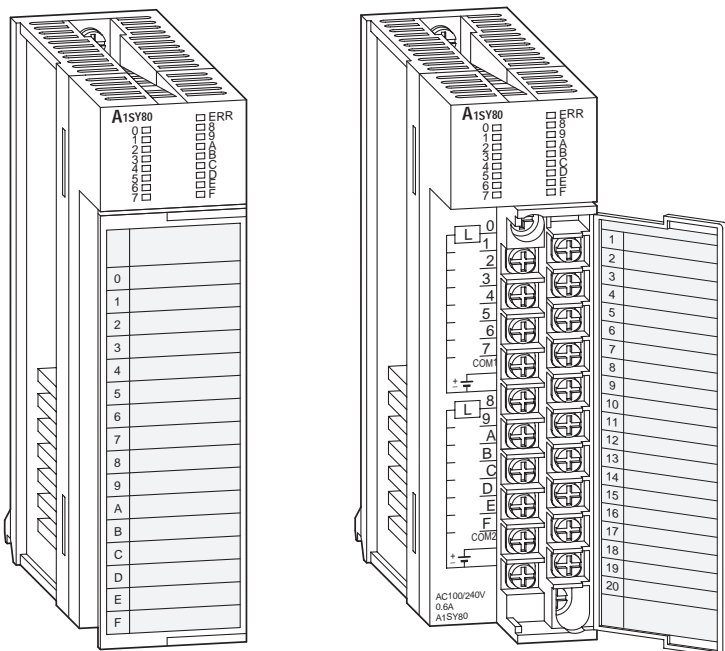

Adapted output technology

The MELSEC AnS output modules have different switching elements for adaptation to many control tasks.

Special features:

- Output modules with relay, transistor or triac switches
- Potential isolation between process and control by means of an optocoupler is a standard feature
- Modules with potential isolation between the channels
- Modules with 16 protection points have removable terminal blocks with screws
- Modules with 32 connection points have a 37-pin D-sub plug (supplied with the module)
- Assembled cables are available for the modules with D-sub plugs (A32CBL: 3 m)

Specifications	A1SY10EU	A1SY14EU	A1SY18AEU	A1SY22 ^①	A1SY28EU	A1SY68A	A1SY80	A1SY81	
Outputs	16	12	8	16	8	8	16	32	
Output type	Relay	Relay	Relay	Triac	Triac	Transistor	Transistor	Transistor	
Common terminal arrangement	points	8	4	1	8	4	1	8	32
Isolation method	Photocoupler isolation between output terminals and PC power for all modules.								
Rated output voltage	24 V DC / 120 V AC	24 V DC / 240 V AC	24 V DC / 240 V AC	100 – 240 V AC	100 – 240 V AC	5 / 12 / 24 / 48 V DC	12 / 24 V DC	12 / 24 V DC	
Operating voltage range	—	—	—	—	—	4.5 – 52.8 V DC	10.2 – 30 V DC	10.2 – 30 V DC	
Min. switching load	5 V DC (1 mA)	5 V DC (1 mA)	5 V DC (1 mA)	24 V AC (100 mA) 100 V AC (10 mA) 240 V AC (20 mA)	24 V AC (15 mA) 100 V AC (15 mA) 240 V AC (15 mA)	—	—	—	
Max. switching voltage	125 V DC / 132 V AC	125 V DC / 264 V AC	125 V DC / 264 V AC	264 V AC	264 V AC	—	—	—	
Max. output current	A	2	2	0.6	0.6	2	0.8	0.1	
Output current per group TYP.	A	8	8	2.4	1.9	2	3.2	2	
Inrush current	—	—	—	20 A for 10 ms, 8 A for 100 ms	30 A for 10 ms, 15 A for 100 ms	8 A for 10 ms	8 A for 10 ms	0.4 A for 10 ms	
Leakage current at OFF	mA	—	—	1.5 mA (120 V AC), 3 mA (240 V AC)	1.5 mA (240 V AC / 60 Hz)	0.1	0.1	0.1	
Response time	ms	10	10	10	1	1	3	2	
	ms	12	12	12	0.5 period + 1 ms	0.5 period + 1 ms	10	2	2
Life	mechanical	Switching 20 million times		—	—	—	—	—	
	electrical	Switching 100000 times or more		—	—	—	—	—	
Max. switching frequency	—	Switching 3600 times/h		—	—	—	—	—	
Noise suppression	—	—	—	CR (0.01µF, 47Ω)	CR (0.01µF, 47Ω)	Zener diode	Zener diode	Zener diode	
Fuse	A	—	—	5	—	—	5	3,2	
Power indicator	All modules possess a status LED per output.								
Fuse blown indicator	—	—	—	LED	—	—	LED	LED	
Connection terminal	20-point removable terminal block							D-Sub plug	
No. of occupied I/O points	16	16	16	16	16	16	16	32	
Applicable wire size	mm ²	0.75 – 1.5	0.75 – 1.5	0.75 – 1.5	0.75 – 1.5	0.75 – 1.5	0.75 – 1.5	0.3	
Ext. power supply req.	voltage	90	100	75	2	—	20	8	
	current	24 V DC, ±10 %	24 V DC, ±10 %	24 V DC, ±10 %	100 – 240 V AC	240 V AC	—	12/24 V DC	12/24 V DC
Internal power consumption (5 V DC)	mA	120	120	240	270	270	110	120	500
Weight	kg	0.25	0.25	0.25	0.24	0.24	0.2	0.2	0.23
Dimensions (W x H x D)	mm	34.5 x 130 x 93.6	34.5 x 130 x 93.6	34.5 x 130 x 93.6	34.5 x 130 x 93.6	34.5 x 130 x 93.6	34.5 x 130 x 93.6	34.5 x 130 x 93.6	34.5 x 130 x 93.6
Order information	Art. no.	53666	54349	53667	24976	54348	33199	24977	24978
Accessories	—	—	—	—	—	—	—	—	Adapter cable

① Does not comply to CE standard



■ MELSEC AnS/QnAS Analog Input Modules

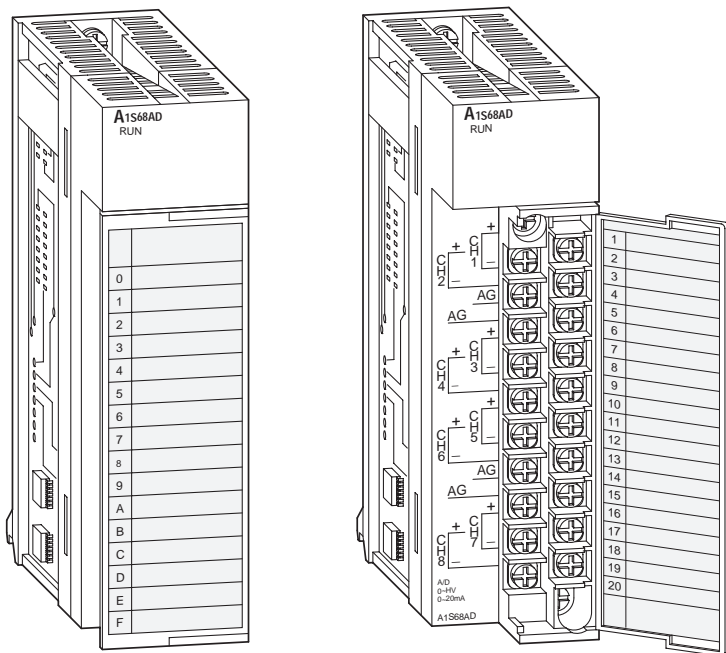

Detection of analog process signals

The analog input modules convert analog process signals, for example pressure, flow or fill level, linearly into digital values, which are further processed by the AnS/QnAS CPU.

Special features:

- Up to 8 channels per module (A1S68AD) and up to 256 channels per system (A2SCPU-S1/A2ASCPU-S1/-S30/-S60)
- Resolution of 0.83 mV and 3.33 μ A (A1S64AD)
- Conversion time of 0.5 msec./channel (A1S68AD)
- Calculation of average value over the time or measurement cycles can be configured
- Potential isolation between process and control by means of an optocoupler is a standard feature.
- The module is provided with a removable terminal block fastened with screws.

Specifications	A1S64AD	A1S68AD							
Input points	4	8							
Analog input	-10 V / +10 V (-20 mA / +20 mA)	-10 V / +10 V (0 mA / +20 mA)							
Resolution	16 bits binary (incl. sign)	16 bits binary (incl. sign)							
Load resistance	voltage $M\Omega$ 1 current Ω 250	1 250							
Max. input	voltage V ± 15 current mA ± 30	± 35 ± 30							
I/O characteristics	Analog input	Digital output	Analog input	Digital output					
	Voltage	Current	1/4000	1/8000	1/12000	Voltage	Current		
	+10 V		4000	8000	12000	0 - +10 V			0 - +4000
	+5 V	+20 mA	2000	4000	6000	-10 - +10 V	0 - 20 mA		-2000 - +2000
	0 V	0 mA	0	0	0	0 - +5 V	4 - 20 mA		0 - +4000
	-5 V	-20 mA	-2000	-4000	-6000	1 - +5 V			0 - +4000
	-10 V		-4000	-8000	-12000				
	resolution		1/4 000	1/8000	1/12000				
Max. resolution	voltage input		2.5 mV	1.25 mV	0.83 mV	0 - +10 V			2.5 mV
						-10 - +10 V			5 mV
	current input		10 μ A	5 μ A	3.33 μ A	0 - +5 V			1.25 mV
						1 - +5 V			1 mV
						0 - 20 mA			5 μ A
						4 - 20 mA			4 μ A
Overall accuracy		± 1.0 % (for the whole measurement range)				± 1.0 % (for the whole measurement range)			
Max. conversion time	ms/channel	20				0.5			
Isolation method		Photocoupler isolation between output terminals and PC power for all modules.							
I/O points		32				32			
Connection terminal		All modules are fitted with a terminal block with 20 screw terminals.							
External power consumption		Not necessary for both modules							
Applicable wire size	mm ²	0.75 - 1.5				0.75 - 1.5			
Internal power consumption (5 V DC)	mA	400				400			
Weight	kg	0.25				0.27			
Dimensions (W x H x D)	mm	34.5 x 130 x 93.6				34.5 x 130 x 93.6			
Order information	Art. no.	25707				46478			

MELSEC AnS/QnAS Analog Output Modules

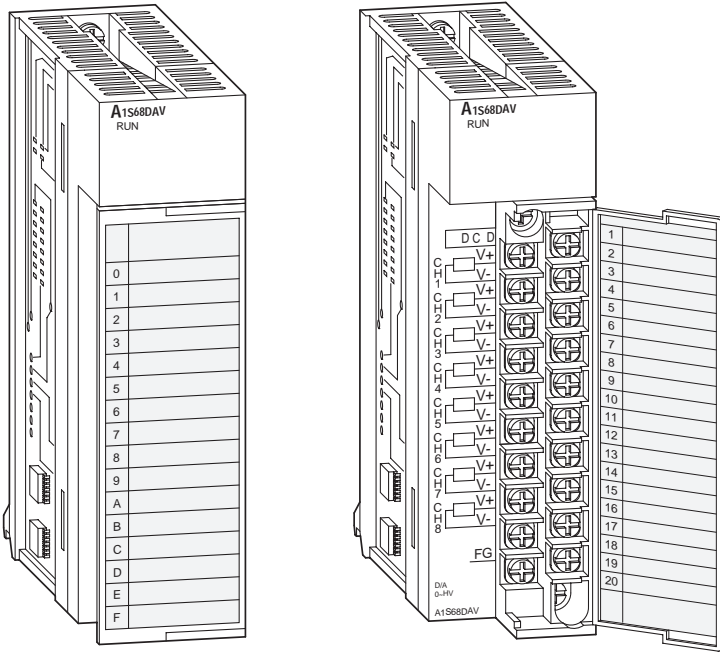

Output of analog control signals

The analog output modules convert digital values predetermined by the CPU into an analog current or voltage signal. For example, frequency inverters, valves or slide valves are controlled by means of these signals.

Special features:

- Up to 8 channels per module (A1S68DAV/DAI) and up to 256 channels per system (A2SCPU-S1/ A2ASCPU-S1/-S30/-S60)
- Resolution of 0.83 mV and 1.7 μ A (A1S62DA)
- Conversion time of 4 msec. / 8 channels (A1S68DAV/DAI)
- Potential isolation between process and control by means of an optocoupler is a standard feature.
- The module is provided with a removable terminal block fastened with screws.

Specifications	A1S62DA	A1S68DAV	A1S68DAI
Output points	2	8	8
Digital input	-4000 – +4000 -8000 – +8000 -12000 – +12000	-2048 – +2047	0 – +4096
Analog output	-10 V DC – +10 V DC (0 mA – +20 mA DC)	-10 V DC – +10 V DC	4 mA – +20 mA DC
Load resistance	voltage: 2 k Ω – 1 M Ω current: 0 – 600 Ω	2 k Ω – 1 M Ω	— 0 – 600 Ω

Voltage output

I/O characteristics	digital input	Voltage output			Voltage output		
		1/4000	1/8000	1/12000	2000	4000	8000
Max. resolution		4000	8000	12000	+10 V	+10 V	—
		2000	4000	6000	+5 V	+5 V	—
		0	0	0	0 V	0 V	—
		-2000	-4000	-6000	-5 V	-5 V	—
Overall accuracy		-4000	-8000	-12000	-10 V	-10 V	—
		2.5 mV	1.25 mV	0.83 mV	(10 V)	5 mV	—

Current output

I/O characteristics	digital input	Current output			Current output		
		1/4000	1/8000	1/12000	20 mA	40 mA	80 mA
Max. resolution		4000	8000	12000	20 mA	—	—
		2000	4000	6000	12 mA	—	—
		0	0	0	4 mA	—	—
		-2000	-4000	-6000	-5 V	-5 V	—
Overall accuracy		-4000	-8000	-12000	-10 V	-10 V	—
		5 μ A	2.5 μ A	1.7 μ A	(20 mA)	—	—
Max. resolution		4000	8000	12000	20 mA	—	—
		2000	4000	6000	12 mA	—	—
Overall accuracy		-2000	-4000	-6000	-5 V	-5 V	—
		4 μ A	—	—	4 μ A	—	—
Overall accuracy		-4000	-8000	-12000	-10 V	-10 V	—
		± 1.0 % (for the whole measurement range)	± 1.0 % (for the whole measurement range)	± 1.0 % (for the whole measurement range)			
Max. conversion time		25 ms / 2 channels (or 1 channel)		4 ms / 8 channels		4 ms / 8 channels	
Isolation method		Photocoupler isolation between output terminals and PC power for all modules.					
I/O points		32		32		32	
Connection terminal		All modules are fitted with a terminal block with 20 screw terminals.					
Applicable wire size	mm ²	0.75 – 1.5		0.75 – 1.5		0.75 – 1.5	
Internal power consumption (5 V DC)	mA	800		650		850	
Weight	kg	0.32		0.28		0.28	
Dimensions (W x H x D)	mm	34.5 x 130 x 93.6		34.5 x 130 x 93.6		34.5 x 130 x 93.6	
Order information	Art. no.	25709		46475		46477	

MELSEC AnS/QnAS Analog Input/Output Modules

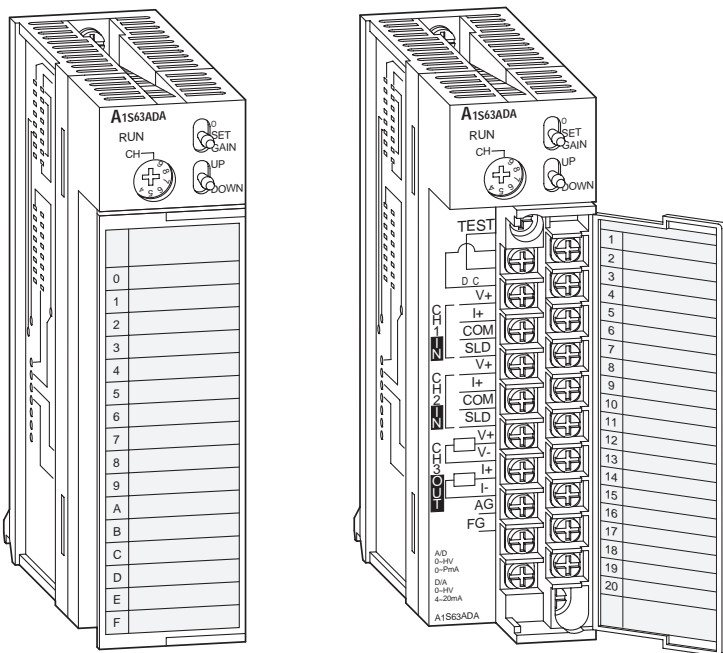

Analog modules with inputs and outputs

These modules have both analog inputs and one or two analog outputs. Individual channels operate autonomously but can also be coupled to one another.

Special features:

- 2 or 4 analog input points and 1 or 2 analog output points
- Resolution of 0.83 mV and 3.3 μ A (input)/ 1.7 μ A (output)
- Extremely short processing time due to high-speed conversion with the A1S66ADA
- Linkage of input/output via formulae or X/Y graph
- Potential isolation between process and control by means of an optocoupler is a standard feature.
- The modules are provided with a removable terminal block fastened with screws.

Specifications	A1S63ADA	A1S66ADA
A/D conversion		
Analog input	-10 V DC – +10 V DC (-20 mA – +20 mA DC)	-10 – 0 – +10 V DC (0 – 20 mA DC)
Resolution	-4096 – +4095 (1/4000), -8192 – +8191 (1/8000), -12288 – +12287 (1/12000)	0 – 4095 (12 bit binary)
I/O characteristics	Analog input	Analog input
	Digital output	Digital output
Max. voltage input resolution	0.83 mV (at resolution 1/12000)	1 mV (for analog input range from 1 to 5 V)
Max. current input	3.3 μ A (at resolution 1/12000)	4 μ A (for analog input range from 4 to 20 mA)
Overall accuracy	\pm 1.0 %	\pm 1.0 %
Max. conversion time	1 ms/channel (at 1/4000); 2 ms/channel (at 1/8000); 3 ms/channel (at 1/12000)	\leq 400 μ s (for 4 channels); scan time 80 μ s (for 1 channel)
Absolute max. input	Voltage: \pm 15 V, current: \pm 30 mA	Voltage: \pm 15 V, current: \pm 30 mA
Analog input points	2	4
D/A conversion		
Digital input	-4000 – +4000 (1/4000), -8000 – +8000 (1/8000), -12000 – +12000 (1/12000)	0 – 4000 (12 bit binary)
Analog output	-10 V – +10 V (0 – +20 mA DC)	-10 – 0 – 10 V DC (0 – 20 mA DC)
I/O characteristics	Digital input	Digital input
	Analog output	Analog output
Max. voltage input resolution	0.83 mV (at resolution 1/12.000)	1 mV (for analog input range from 1 to 5 V)
Max. current input	1.7 μ A (at resolution 1/12.000)	4 μ A (for analog input range from 4 to 20 mA)
Overall accuracy	1.0 % (to the maximum value)	1.0 % (to the maximum value)
Max. conversion time	1 ms (1/4000), 2 ms (1/8000), 3 ms (1/12000)	\leq 240 μ s (for 2 channels); scan time 80 μ s (for 1 channel)
Absolute max. output	Voltage: \pm 12 V, current: \pm 28 mA	Voltage: \pm 12 V, current: \pm 28 mA
Analog output points	1	2
Isolation method	Photocoupler isolation between output terminals and PC power.	Photocoupler isolation between output terminals and PC power.
I/O points	32	64
Connection terminal	The module is fitted with a terminal block with 20 screw terminals.	The module is fitted with a terminal block with 20 screw terminals.
Applicable wire size	mm ² 0.75 – 1.5	0.75 – 1.5
Internal power consumption (5 V DC)	mA 800	210
Weight	kg 0.3	0.33
Dimensions (W x H x D)	mm 34.5 x 130 x 93.6	34.5 x 130 x 93.6
Order information	Art. no. 36251	70543

MELSEC AnS/QnAS Analog Modules for Pt100-Elements

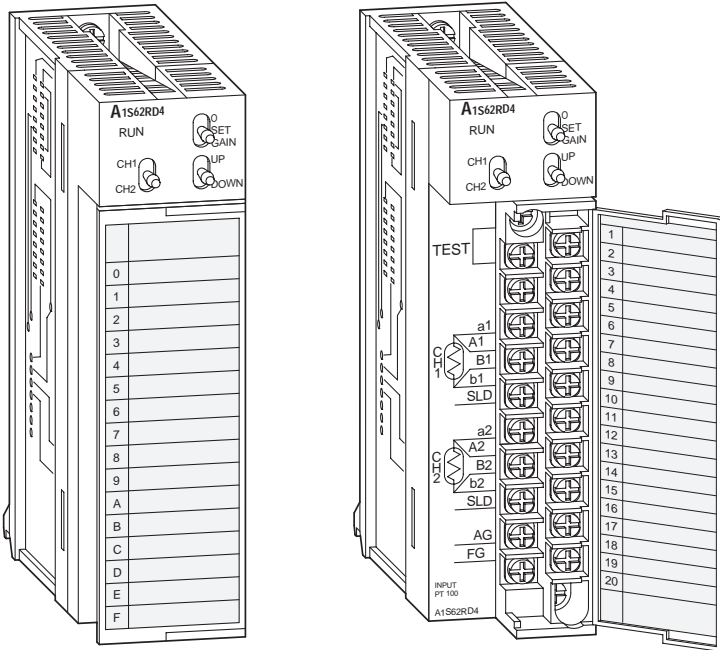

Temperature measurement by resistance thermometer

These analog modules are used for direct connection of Pt100 resistance thermometers. The measurement is based on the three-conductor or four-conductor method.

Special features:

- Linearized measuring range from -180 °C to 600 °C
- Pt100 elements according to DIN and JIS are supported.
- A cable break is indicated to the CPU by the module.
- Calculation of average value over the time or measurement cycles can be configured.
- Potential isolation between process and control by means of an optocoupler is a standard feature.
- The module is provided with a removable terminal block fastened with screws.

Specifications	A1S62RD3	A1S62RD4
Method of measurement	3-wire type	4-wire type
Pt100-input points	2	2
Connectable temperature measuring resistants	Pt100 (conforms to JIS C 1604-1989 and DIN IEC 751), JPt100 (conforms to JIS C 1604-1981)	
Temperature input range	°C Pt 100: -180 – 600 (27.08 Ω – 313.59 Ω), JPt 100: -180 – 600 (25.8 Ω – 317.28 Ω)	
Detected temperature value	16 bits signed binary: -1800 – +6000 32 bits signed binary: -180000 – +600000	16 bit signed binary: -1800 – +6000 32 bit signed binary: -180000 – +600000
Max. resolution	°C 0.025	
Overall accuracy	±1 % (to the maximum value)	
Max. conversion time	40 ms per channel ON	
Isolation method	No isolation between channels. Photocoupler isolation between input terminal and PC CPU power.	
I/O points	32	
Connection terminal	All modules are fitted with a terminal block with 20 screw terminals.	
Applicable wire size	mm ² 0.75 – 2	0.75 – 2
Internal power consumption (5 V DC)	mA 540	440
Weight	kg 0.29	0.28
Dimensions (W x H x D)	mm 34.5 x 130 x 93.6	34.5 x 130 x 93.6
Order information	Art. no. 25710	25712



MELSEC AnS/QnAS Analog Module for Temperature Measurement

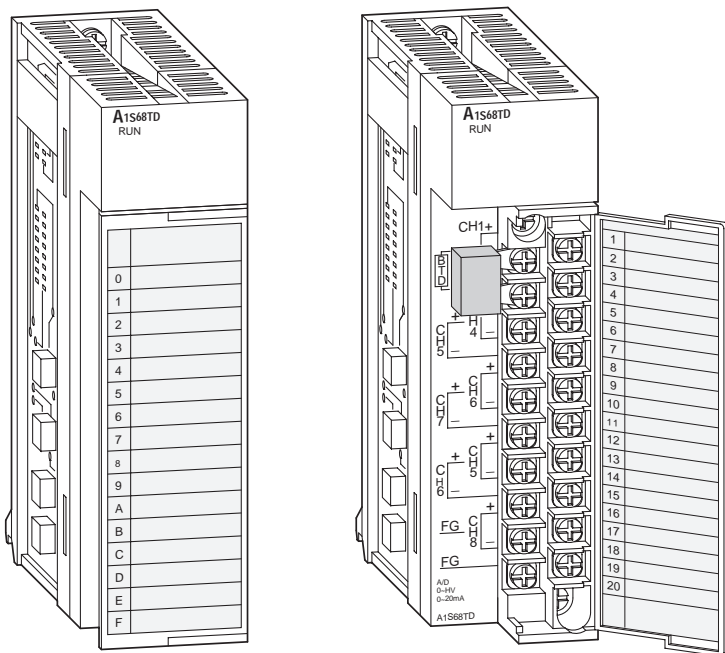

Temperature measurement by thermocouple

This module is used for temperature measurement by means of a thermocouple. The reference temperature is determined by means of a Pt100 resistance thermometer.

Special features:

- The module has 8 thermocouple inputs and a Pt100 input for the reference temperature.
- Linearized measuring range up to 1700 °C (thermocouple-dependent)
- The thermocouple types B, R, S, K, E, J and T with the thermoelectric voltage curves according to DIN IEC 584-1 are supported.
- Potential isolation between process and control by means of an optocoupler is a standard feature.
- The module is provided with a removable terminal block fastened with screws.

Specifications	A1S68TD			
Input points	8			
Temperature input range	°C	0 – 1700		
Detected temperature value	16 bits signed binary: 0 – 17000 (value to the first decimal place x 10)			
Scaling value	°C	16 bits signed: 0 – +2000		
Thermocouple	Type	Temperature measurement range	Conversion accuracy (at operating ambient temperature is Ta = 25 ± 5°C)	Temperature characteristic (when operating ambient temperature varies by ΔT = 1 °C)
	B	800 – 1700 °C	±2.5 °C	±0.4 °C
	R	300 – 1600 °C	±2 °C	±0.3 °C
	S	300 – 1600 °C	±2 °C	±0.3 °C
	K	0 – 1200 °C		
	E	0 – 800 °C	±0.5 °C or 0.25 % of the measured temperature which ever is larger	±0.07 °C or 0.02 % of the measured temperature which ever is larger
	J	0 – 750 °C		
	T	0 – 350 °C		
Cold junction compensation accuracy	±1 °C			
Overall accuracy	(Conversion accuracy Ta) + (temperature characteristic) x (operating ambient temperature variation) ± 1 °C*			
Max. resolution	B, R, S: K, E, J, T:	0.3 °C 0.1 °C		
Max. conversion time	400 ms / 8 channels, without respect to the number of used channels			
Absolute max. input voltage	V	±5		
Isolation method	Transformer			
I/O points	32			
Connection terminal	The module is fitted with a terminal block with 20 screw terminals.			
Applicable wire size	mm ²	0.75 – 1.5		
Internal power consumption (5 V DC)	mA	320		
Weight	kg	0.28		
Dimensions (W x H x D)	mm	34.5 x 130 x 93.6		
Order information	Art. no.	46476		

* Example:

Overall accuracy = (conversion accuracy at Ta = 25 °C ± 5 °C) + (temperature characteristic by ΔT = 1 °C) x (operating ambient temperature variation) + (± 1 °C)
 Example for thermocouple type 3 when the operating ambient temperature is 35 °C = (±2.5 °C) + (±0.4 °C) x (5 °C) + (±1 °C) = ±5.5 °C

Ta = operating ambient temperature
 ΔT = operating ambient temperature variation

MELSEC AnS/QnAS Temperature Control Modules

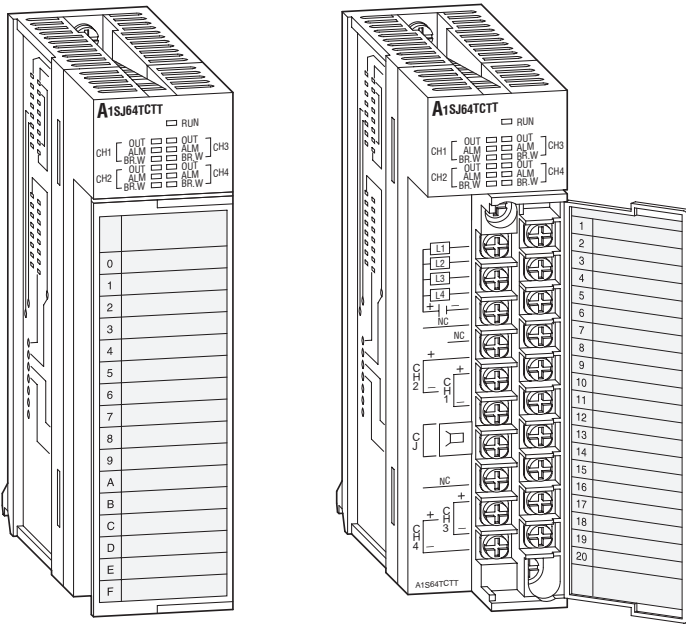

Temperature control modules with PID algorithm

These modules enable PID algorithm temperature control without placing any load on the PLC CPU for the temperature control tasks.

Special features:

- Four temperature input channels
- Auto-tuning function for the 4 PID control circuits
- Temperature control can continue even when the PLC program is stopped
- Transistor output with pulse train to drive the actuator in the control circuit
- The module is provided with a removable terminal block fastened with screws



Specifications	A1S64TCRT-S1	A1S64TCTT-S1
Control output type	Transistor	Transistor
Inputs	4 channels per module	4 channels per module
Supported thermocouples	Pt100 (-200 – +600 °C), JPt100 (-200 – +500 °C)	R, K, J, T, S, B, E, N, U, L, P L II, W5Re/W26Re
Sampling cycle	0.5 s / 4 channels	0.5 s / 4 channels
Control output cycle	s 1 – 100	1 – 100
Input filter	1 – 100 s (0 s: input filter OFF)	1 – 100 s (0 s: input filter OFF)
Temperature control method	PID ON/OFF impulse or 2-position control	PID ON/OFF impulse or 2-position control
PID constant range	PID constant setting	Setting with automatic tuning possible
	proportional band P	0.0 – 100.0 % (0 %: 2-position control)
	integral constant I	1 – 3600 s
	differential constant D	1 – 3600 s (0 setting for PID control)
Target value setting range	Within the temperature range of the Pt100 sensor used	Within the temperature range of the thermocouple used
Dead band setting range	0.1 – 10.0 %	0.1 – 10.0 %
Transistor output	output signal	ON/OFF pulse
	rated load voltage	10.2 – 30 V DC
	max. load current	0.1 mA/1 point, 0.4 mA/common
	max. rush current	400 mA for 10 ms
	max. voltage drop when ON	0.1 V DC (TYP) 0.1 A 2.5 V DC (MAX) 0.1 A
	response time	OFF → ON: < 2 ms ON → OFF: < 2 ms
Isolation method	Transformer	Transformer
I/O points	32	32
Connection terminals	The module is fitted with a terminal block with 20 screw terminals.	The module is fitted with a terminal block with 20 screw terminals.
Applicable wire size	mm ² 0.75 – 1.5	0.75 – 1.5
Internal power consumption (5 V DC)	mA 330	420
Weight	kg 0.27	0.3
Dimensions (W x H x D)	mm 34.5 x 130 x 93.6	34.5 x 130 x 93.6
Order information	Art. no. 126507	66227

■ MELSEC AnS/QnAS High-Speed Counter Modules

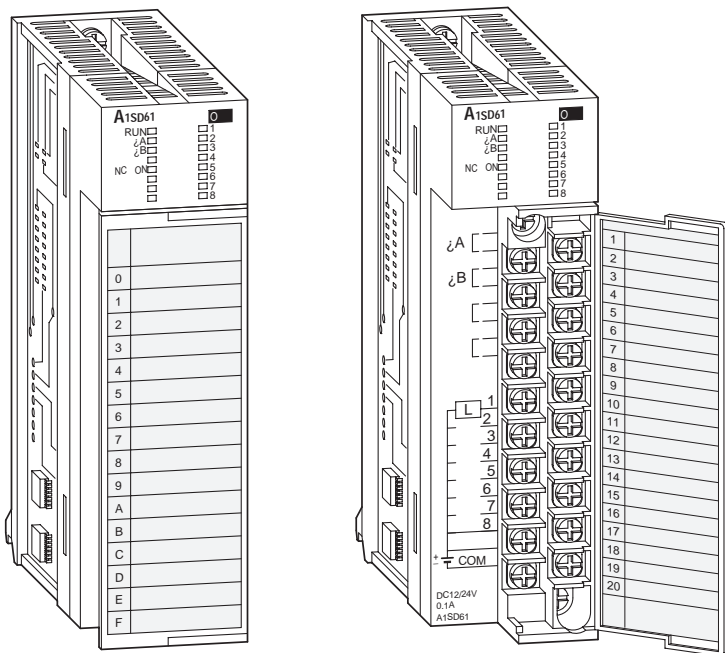

High-speed counter with automatic detection of rotation direction

These counter modules detect signals with a frequency which cannot be detected by normal input modules. For example, simple positioning tasks or frequency measurements can be realized.

Special features:

- Input for incremental shaft encoder with automatic forward and reverse detection
- Preset count via external signals or the PLC program with the aid of the PRESET function
- Ring counter function for counting up to a pre-defined value with automatic resetting to the starting value
- Functions such as speed measurement, definition of switching points or periodic counting are available.
- The module is provided with a removable terminal block fastened with screws.

Specifications	A1SD61	A1SD62E
Counter inputs	1 for incremental rotary transducer	2
Signal levels	5 / 12 / 24 V DC (2 – 5 mA)	5 / 12 / 24 V DC (2 – 5 mA)
Max. counting frequency	kHz 50	100
Max. counting speed	1-phase-input kHz 50 or 10	100 or 10
	2-phase-input kHz 50 or 7	100 or 7
Counting range	31 bits + sign (binary), -2147483648 – +2147483647	23 bits + sign (binary), 0 – 16777215
Counter type	Both modules are equipped with UP/DOWN preset counter and ring counter function.	
Comparison range	31 bits + sign (binary)	24 bits + sign (binary)
External digital input points	Preset, function start	Preset, function start
Rated voltage/current for external input	5 / 12 / 24 V DC (3 – 6 mA)	5 / 12 / 24 V DC (2 – 5 mA)
External digital output points (Coincidence signal)	8 transistor outputs (open collector) 12 / 24 V DC, 0.1 A/point, 0.8 A/common	4 transistor outputs (2/point) (source type) 12 / 24 V DC, 0.1 A/point, 0.4 A/common
I/O points	32	32
Connection terminal	All modules are fitted with a detachable terminal block with 20 screw terminals.	
Applicable wire size	mm ² 0.75 – 1.5	0.75 – 1.5
Internal power consumption (5 V DC)	mA 350	100
Weight	kg 0.27	0.25
Dimensions (W x H x D)	mm 34.5 x 130 x 93.6	34.5 x 130 x 93.6
Order information	Art. no. 25713	54951

MELSEC AnS/QnAS Timer Module

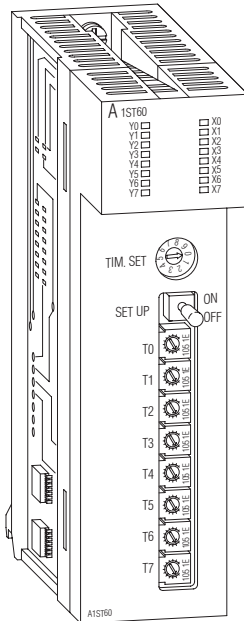

Set timers directly without any programming

The A1ST60 provides 8 timers that can be set directly with a screwdriver to values between 0.1 and 600 seconds.

Special features:

- Eight additional hardware timers to supplement the PLC CPU's own internal timers
- Timer setting ranges:
 - 0.1 to 1.0 s
 - 1 to 10 s
 - 10 to 60 s
 - 60 to 600 s
- Timer status indicated by LEDs
- Integrated pause function for stopping the time of active timers



Specifications	A1ST60	
Input points	8 potentiometers for timer setting	
Timer setting range	0.1 – 1.0 s, 1 – 10 s, 10 – 60 s, 60 – 600 s	
Overall accuracy	±2.0 %	
Setting possibilities	Separate setting with potentiometers and DIP switches	
I/O points	16	
Applicable wire size	mm ²	0.75 – 1.5
Internal power consumption (5 V DC)	mA	55
Weight	kg	0.13
Dimensions (W x H x D)	mm	34.5 x 130 x 93.6
Order information	Art. no.	33196

MELSEC AnS/QnAS Axes Positioning Modules

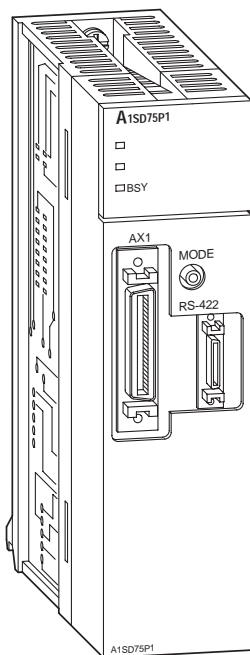

Positioning with an open control loop

The modules generate the travel command via a pulse chain. The speed is proportional to the pulse frequency and the distance travelled is proportional to the pulse length.

Special features:

- Control of up to three axes with linear interpolation (A1SD71-S2, A1SD75P2/P3) or circular interpolation (A1SD75P2/P3)
- Storage of up to 400 positional data in the A1SD71-S2 (battery-supported) or 600 positional data in the A1SD75P1/P2/P3 (flash ROM)
- Units of travel can be defined in pulses, mm, inch or degrees.
- In the A1SD71-S2, configuration and presetting of positional data is performed via the PLC program or with the aid of the teaching unit AD71TU.
- In the A1SD75P1/P2/P3, configuration and presetting of positional data is carried out by means of the PLC program (all 400 positional data) or with the aid of the MS-DOS software SW1IVD-AD75PE

Specifications	A1SD71-S2	A1SD75P1-S3	A1SD75P2-S3	A1SD75P3-S3	
Control axes	2	1	2	3	
Interpolation	Linear interpolation	—	Linear and circular interpolation	Linear and circular interpolation	
Points per axis	400	Peripheral: 600, PC: 100	Peripheral: 600, PC: 100	Peripheral: 600, PC: 100	
Output signal	Pulse generator phase	Pulse generator phase	Pulse generator phase	Pulse generator phase	
Output frequency	kHz	10 – 200000	1 – 400000	1 – 400 000	
Positioning	method	Pulse control: absolute data and/or incremental; speed/position switching control: incremental; locus control: absolute data and/or incremental			
	positioning units	1 – 16252928 pulse, max. 162 m (command unit: 0.1 – 10 mm/pulse), max. 16200 degree or max. 16200 inch (command unit: 1 x 10 ⁵ – 0.001 degree/pulse 1 x 10 ⁵ – 0.001 inch/pulse)	Absolute data method: -2147483648 – -214748364.7 pulse -214748364.8 – -21474.83647 μm -21474.83648 – -21474.83647 inch 0 – 359.99999 degree	Incremental method: -2147483,648 – -2147483,647 pulse -214 748 364.8 – -214 748 364.7 μm -21474.83648 – -21474.83647 degree -21 474.83648 – -21474.83647 inch	Speed/position switching control: 0 – 2147483647 pulse 0 – 214748364.7 μm 0 – 21474.83647 degree 0 – 21474.83647 inch
	positioning speed	10 – 200000 pulse/s, 10 – 120000 mm/min, 1 – 12000 degree/min 1 – 12000 inch/min	1 – 1000000 pulse/min 0.01 – 6000000.00 mm/min 0.001 – 600000.000 degree/min 0.001 – 600000.000 inch/min		
	acceleration/deceleration processing	Automatic trapezoidal acceleration and deceleration	Automatic trapezoidal or S-pattern acceleration and deceleration		
acceleration and deceleration time	64 – 50000 ms	1 – 65535 [8388608]* ms (4 patterns each can be set)			
rapid stop deceleration time		1 – 65535 [8388608]* ms			
I/O points	48 (2 slots)	32	32	32	
Internal power consumption (5 V DC)	mA 800	700	700	700	
External power consumption (4.75 – 26.4 V DC)	mA 50	—	—	—	
Weight	kg 0.38	0.35	0.35	0.35	
Dimensions (W x H x D)	mm 69.5 x 130 x 93.6	34.5 x 130 x 93.6	34.5 x 130 x 93.6	34.5 x 130 x 93.6	
Order information	Art. no. 33200	65028	65029	65030	
Accessories	Software for all A1SD75: SW1□VD-AD75PE, art. no.: 65619; adapter cable: A1SD75-C01H, art. no.: 54943; spare part plug for axis control, 36 pins, art. no.: 62890				

* Values in brackets indicate stepping motor mode

MELSEC AnS/QnAS Single Axis Positioning Module

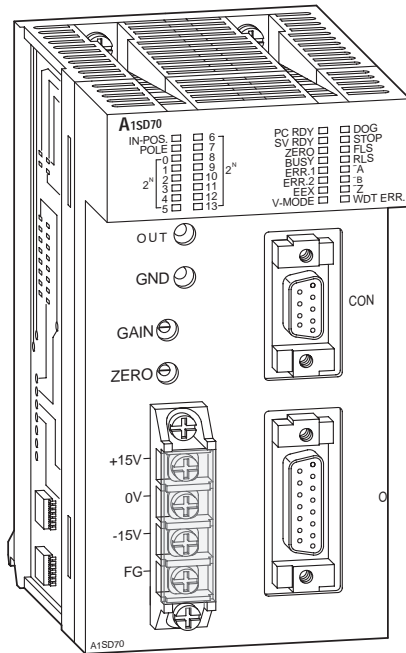

Positioning with position control loop

The module is used for positioning by means of servo drives. Here, the output delivers an analog voltage. To monitor the position, the displacement transducer is fed back to the module.

Special features:

- The positional data is preset by means of the PLC program.
- Integrated digital/analog converter for converting the digital adjustment into an analog signal
- Online speed and address change possible
- Online monitoring of setpoint value (command pulses), actual value (feedback pulses) and adjustment (difference between command and feedback)
- An electronic gear function permits adjustment of the distance travelled per pulse

Specifications	A1SD70
Axes	1 (with position control)
Signal input level	5 V DC (TTL, RS422), 12 V DC (open collector)
Max. counting frequency	kHz 100
Counting resolution	31 bits + sign (binary), -2 147 483 648 – +2 147 483 647
Acceleration/deceleration time	ms 2 – 9999
Positioning speed	1 – 400000 pulses/s
External digital inputs	Zero, stop, upper/lower range limit, servo ready, control mode
Input rating	5 – 24 V DC (6 mA)
External digital outputs	Servo error / module error
Output rating	5 – 24 V DC
In position control range	Adjustable between 1 – 2047 pulses (hard / smooth)
Acceleration and deceleration	Automatic, trapezoidal acceleration and deceleration
Analog output for speed control	≤ 10 V DC (adjustable between ±5 V and ±10 V)
I/O points	48 (2 slots)
Internal power consumption (5 V DC)	mA 300
External power consumption	200 mA (+15 V DC), 20 mA (-15 V DC)
Weight	kg 0.4
Dimensions (W x H x D)	mm 69.5 x 130 x 93.6
Order information	Art. no. 29539



■ MELSEC AnS/QnAS Interface Modules

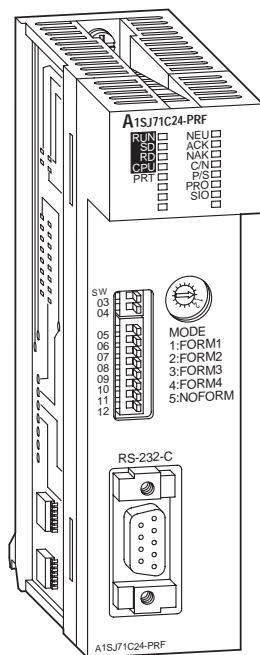

Data exchange with peripheral devices

This module enables communication with peripheral devices via a standard RS-232C interface. The peripherals are connected point-to-point on a 1:1 basis.

Special features:

- Enables PCs connected to the system to access the full data set of the MELSEC AnS CPU using graphic process supervision or monitoring software
- Support for plain ASCII data exchange with connected devices such as barcode readers, scales and identification systems
- Options for connection of a printer
- Integrated 32KB EEPROM memory for logging quality, productivity or alarm data that can be printed out when required
- Module and communications status shown by LEDs
- The A1S71UC24-R4 has the same features as the A1S71UC24-R2. The only difference is that a PC can access up to 32 controllers via RS422/485 version.

Specifications		A1S71UC24-R2	A1S71UC24-R4	A1S71UC24-PRF
Interface	type	RS232C	RS422 / 485	RS232C
Communications mode		Full duplex / half duplex	Full duplex / half duplex	Full duplex / half duplex
Synchronisation		Asynchronous communications	Asynchronous communications	Asynchronous communications
Data transfer	rate	300 – 19200	300 – 19200 (computer link) 19200 – 38400 (multidrop)	300 – 19200
	distance	15	500	15
Max. no of stations in a multidrop network		—	32	—
Data format		1 start bit, 7 or 8 data bits, 1 or 0 parity bits, 1 or 2 stop bits	1 start bit, 7 or 8 data bits, 1 or 0 parity bits, 1 or 2 stop bits	1 start bit, 7 or 8 data bits, 1 or 0 parity bits, 1 or 2 stop bits
Error correction		Parity check, checksum	Parity check, checksum	Parity check, checksum
DTR/DSR control		YES / NO selectable	YES / NO selectable	YES / NO selectable
X ON / X OFF (DC1 / DC3)		YES / NO selectable	YES / NO selectable	YES / NO selectable
EEPROM memory		—	—	32 kbyte (400 x 80 characters)
I/O points		32	32	32
Internal power consumption (5 V DC)	mA	100	100	100
Weight	kg	0.49	0.55	0.22
Dimensions (W x H x D)	mm	34.5 x 130 x 93.6	34.5 x 130 x 93.6	34.5 x 130 x 93.6
Order information	Art. no.	64561	64562	29537

MELSEC AnS/QnAS MODBUS Slave Interface Modules

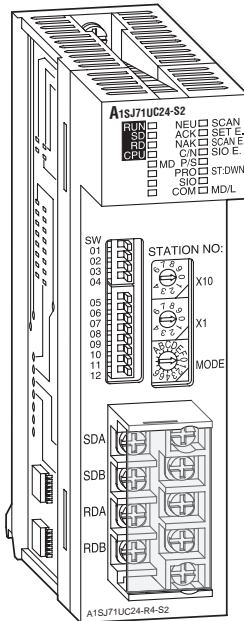

Modbus protocol via RS232 / RS422 / RS485

The A1SJ71UC24-R4-S2 and A1SJ71UC24-R2-S2 enable third-party devices to access MELSEC AnS and QnAS controllers using the MODBUS protocol.

Special features:

- Support for both ASCII and RTU procedures
- Slave functionality – up to 31 MELSEC controllers can be allocated to a third-party device.
- Support for functions 1, 3, 5–8, 11, 12, 15–17, 20 and 21
- Enables access to the entire data of AnAS respec. QnAS CPUs.

Specifications		A1SJ71UC24-R2-S2	A1SJ71UC24-R4-S2
Module type		Slave	Slave
Interface	type	RS232	RS422 / 485
Communications mode		Half duplex	Half duplex
Synchronisation		Asynchronous communications	Asynchronous communications
Data transfer	rate	bit/s 300 – 19200	300 – 19200
	distance	m 15	500
	mode	ASCII and RTU	ASCII and RTU
Data format	bit	1 start bit, 7 or 8 data bits, 1 or 0 parity bits, 1 or 2 stop bits	1 start bit, 7 or 8 data bits, 1 or 0 parity bits, 1 or 2 stop bits
Error correction		Parity check (ASCII mode: LRC, RTU mode: CRC-16)	Parity check (ASCII mode: LRC, RTU mode: CRC-16)
Isolation method		Photocoupler	Photocoupler
I/O points		32	32
Internal power consumption (5 V DC)	mA	100	100
Weight	kg	0.49	0.55
Dimensions (W x H x D)	mm	34.5 x 130 x 93.6	34.5 x 130 x 93.6
Order information	Art. no.	54355	54354
Accessories		Interface converter CR01-R2/R4 SET, art. no. 56172 (refer to page 79)	



■ MELSEC QnAS Interface Modules

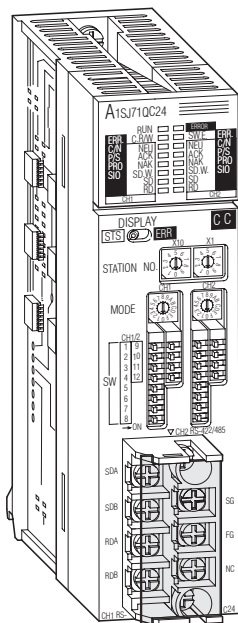

High-speed data communications

The QnAS interface modules provide extremely high data throughput rates, which can be invaluable for process supervision software and similar applications. Up to 480 data words can be exchanged between the PLC CPU and the PC per END instruction.

Special features:

- Enables PCs connected to the system to access the full data set of the MELSEC QnAS CPU with process supervision or monitoring software
- Support for plain ASCII data exchange with connected devices such as barcode readers, scales and identification systems
- Compatible to A1SJ71UC24R2/R4 with protocol formats 1 – 4
- When the special dedicated Q instructions are used (protocol format 5) PC process supervision software can access data at least 5 times faster than it is now possible using the conventional protocol formats 1 – 4.
- The integrated EEPROM can store up to 200 pre-programmed protocols for accessing third-party devices.

Specifications		A1SJ71QC24-R2	A1SJ71QC24
Interface	Typ	2 x RS232C	1 x RS232, 1 x RS422 / 485
Communications mode		Full duplex / half duplex	Full duplex / half duplex
Synchronisation		USART	USART
Data transfer	rate	300 – 19200 bit/s	300 – 19200
	distance	15 m	1200
Max. stations in a multidrop network		—	32
Data format	bits	1 start bit, 7 or 8 data bits, 1 or 0 parity bits, 1 or 2 stop bits	1 start bit, 7 or 8 data bits, 1 or 0 parity bits, 1 or 2 stop bits
Error correction		Parity check, checksum	Parity check, checksum
		RS232	RS232 RS422/485
Flow control	DTR / DSR	●	● ●
	RS / CS	●	● —
	CD	●	● —
	DC	●	● ●
X ON / X OFF (DC1 / DC3)		YES / NO selectable	YES / NO selectable
I/O points		32	32
Internal power consumption (5 V DC)	mA	160	240
Weight	kg	0.249	0.294
Dimensions (W x H x D)	mm	34.5 x 130 x 93.6	34.5 x 130 x 93.6
Order information	Art. no.	66542	66543
Accessories		Interface converter CR01-R2/R4-SET, art. no. 56172 (refer to page 79)	

MELSEC AnS/QnAS High-Speed Communications Module

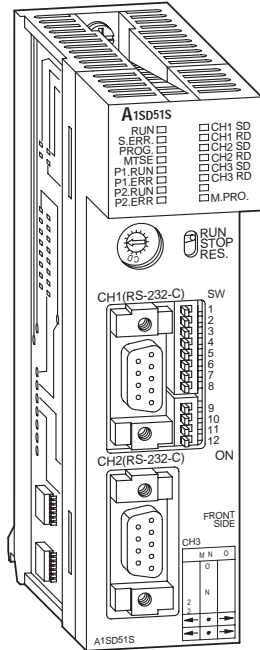

Programmable interface module

This module works through its own program independently of the PLC CPU. Thus, peripherals can be operated or mathematical operations performed without imposing an additional load on the PLC CPU. Programming is in AD51H BASIC.

Special features:

- Two RS232C interfaces and one RS422/485 interface
- Two BASIC programs can be operated in parallel (multitasking).
- The tasks can be stored in the module as interpreter programs or in compiled form.
- The integrated EEPROM is used for storage.
- Online and offline program creation is possible.
- The module and communication status is indicated by means of LEDs.

Specifications		A1SD51S
Interfaces	type	1 x RS422/485, 2 x RS232
Microprocessor	type	80C186 (15 MHz)
Number of parallel tasks		Max. 2
Start conditions for tasks		Started by power on, started by the start command from another task, start by an interruption from the PC CPU.
Data transfer	rate	bit/s 300 – 19200
	distance	m 500 (RS422/485), 15 (RS232C)
Program language		AD51H-BASIC
Internal memory	program memory	kbyte 64 x 1 task or 32 x 2 tasks
	common memory for tasks	kbyte 8
	data buffer to PLC	kbyte 6
	extension relays	1024
	extension data registers	1024 (2 kbyte)
Memory backup capability		Provided for common memory, extension relay and extension register.
Memory for programs		EEPROM memory: 64 kbyte
I/O points		32 (1 slot)
Internal power consumption (5 V DC)	mA	400
Weight	kg	0.3
Dimensions (W x H x D)	mm	34.5 x 130 x 93.6
Order information	Art. no.	46276
Accessories		Programming software for PC/AT (MS-DOS): SW11X-AD51HPE, art. no.: 33102



■ MELSEC AnS/QnAS High-Speed Communications Module

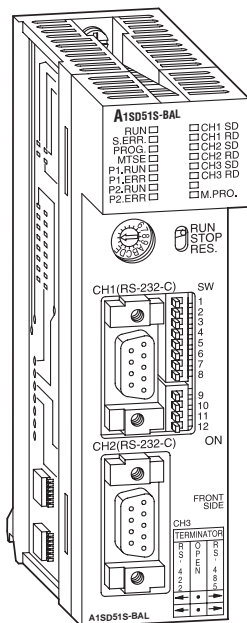

Communications module with 3964R procedure

The A1SD51S-BAL has 3 standard interfaces for communications with intelligent peripheral devices that support the 3964R (RK512 active) communications protocol. This makes it possible to connect products from other manufacturers without any additional programming.

Special features:

- All three interfaces can be used simultaneously.
- You can store up to 30 commissions by setting the appropriate parameters.
- Up to 10 commissions can be executed simultaneously.
- Optoelectronic couplers for isolation of process and control systems are fitted as standard equipment
- The module can request data from e.g. a S5-CP525 or CP524 via the 3964(R)RK512 procedure. However, it can not respond to the requests of other devices.

Specifications		A1SD51S-BAL
Interface	type	2 x RS232, 1 x RS422
Transmission system		Half duplex / full duplex
Synchronisation		Asynchronous communications
Data transfer	rate	300 – 9600 bit/s
	distance	15 m at RS232, 500 m at RS422
Data format		1 start bit, 7 or 8 data bits, 1 or 0 parity bit, 1 or 2 stop bit
Error correction method		Parity check, checksum
Supported 3964R (RK512) functions		FETCH and SEND data block (active). The module can not respond to requests from other stations.
Supported data blocks		DB0 and DB255
Supported A series devices		D, W, R
Processing time for FETCH or SEND of 32 data words		ms Approx. 300
X ON / X OFF (DC1 / DC3)		YES / NO selectable
I/O points		32
Internal power consumption (5 V DC)		mA 400
Weight		kg 0.3
Dimensions (W x H x D)		mm 34.5 x 130 x 93.6
Order information		Art. no. 65065
Accessories		—

ETHERNET

Data communications

ETHERNET is now one of the most widely-used networks. It provides the link between the office world and control systems. ETHERNET is a platform for a very wide range of data communications protocols. The combination of ETHERNET and the extremely widespread TCP/IP protocol enables high-speed data communications between process supervision systems and the MELSEC AnSH, QnAS, AnU and QnA series.

Structure

Up to 5 ETHERNET segments can be linked to one another per repeater. There are two standard cable types: "Yellow" cable using the 10BASE5 interface and "Cheapernet" cable (Thin Ethernet) using the 10BASE2 interface.

Bus segments using Yellow cable can be up to 500m long. Cheapernet configurations support bus segment cable lengths of up to 185m.

Data exchange

TCP/IP provides logical point-to-point links between two ETHERNET stations. Using the TCP/IP protocol a process supervision system can request 256 data words per query, or a full 480 words if a QnAS compatible ETHERNET card is used. The speed of the response to the query varies depending on the type of CPU used (AnAS or QnAS) and the ETHERNET module. The response time of a pure QnAS system (QnAS + A1SJ71QE71-B2/B5) is around eight times faster than that of an equivalent AnAS system.

FTP server functionality

The QnAS compatible ETHERNET modules also provide FTP server functionality, in addition to the normal TCP/IP communications services. This means that a personal computer running standard communications software can read from and write to the QnAS CPU sequence program via the Internet.

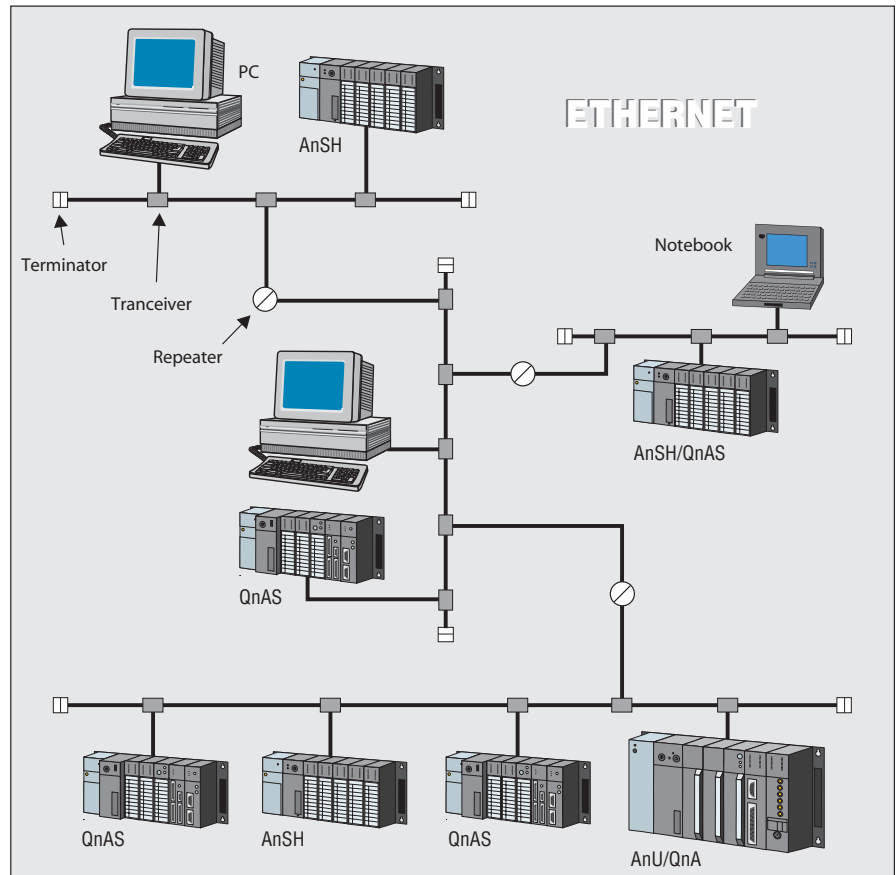

Administration

MELSEC MEDOC *plus* function blocks are available for all the PLC CPUs, making the configuration of one or more TCP/IP links a quick and easy process.

Cable and logic diagnostics are also simple because all MELSEC ETHERNET cards support the PING instruction.

Specifications	Yellow Cable	Thin Ethernet, Cheapernet
Cable type	10BASE5	10BASE2
Max. distance between 2 stations	2500 m	925 m
Min. distance between 2 stations	2.5 m	0.5 m
Max. segment length	500 m	185 m
Max. permitted no. of repeaters	4	4
Max. stations per segment	100	30

■ MELSEC AnS ETHERNET Module

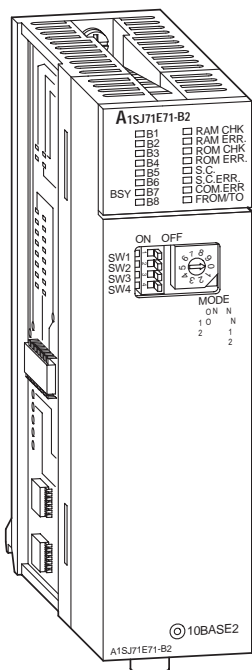

The high-speed connection to the PLC

This module connects the MELSEC AnS system to the open, non-proprietary ETHERNET. This enables process supervision packages and other programs from a wide variety of vendors to access all devices of the controller at a rate of 10 Mbits per second.

Special features:

- Both cable types are supported:
 - 10BASE2 (Cheapernet using RG58 coax cable)
 - 10BASE5 (ETHERNET using Yellow cable)
- Communications protocol TCP/IP with ARP
- Module and communication status indicated by LEDs
- Full support for the MELSEC MEDOC *plus* programming software package (read and write programs, monitoring, remote PLC operating mode change (RUN/STOP))
- Ready-to-use MELSEC MEDOC *plus* function block available
- Integrated bus cable diagnostics
- PING diagnostics function support
- Automatically detects whether the communication partner is ready to communicate.

Specifications	A1S71E71-B2-S3	A1S71E71-B5-S3
Module type	Client / server	Client / server
Communications method	ETHERNET: CSMA/CD	ETHERNET: CSMA/CD
Interface	10BASE2	10BASE5
Communications data	transfer rate	10
	transfer type	Base band
	max. network length	925
	max. segment length	185
	nodes	Max. 30/segment
	min. distance between 2 nodes	0.5
Data buffer	fixed buffer	2 kbyte x 8
	RAM buffer	6 kbyte x 2
Simultaneous connections	Max. 8	Max. 8
Transport protocol	TCP/IP with ARP, UDP/IP	TCP/IP with ARP, UDP/IP
I/O points	32	32
Internal power consumption (5 V DC)	520	350
Weight	0.27	0.27
Dimensions (W x H x D)	34.5 x 130 x 93.6	34.5 x 130 x 93.6
Order information	Art. no. 62663	62662
Accessories	—	—

MELSEC QnAS ETHERNET Module

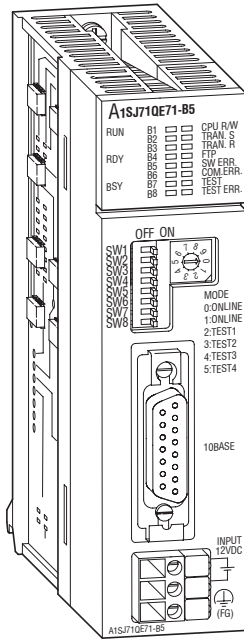

The high-speed connection for the QnAS series

This module connects the MELSEC QnAS system to the open, non-proprietary ETHERNET. This enables process supervision packages and other programs from a wide variety of vendors to access all devices of the QnAS controller at a rate of 10 Mbits per second.

Special features:

- Both cable types are supported:
 - 10BASE2 (Cheapernet using RG58 coax cable)
 - 10BASE5 (ETHERNET using Yellow cable)
- Communications protocol TCP/IP with ARP
- PING diagnostics function support
- FTP server function enabling program uploads and downloads via the Internet with standard communications software
- Rapid response times because the system can exchange 480 data words per protocol
- Integrated easy bus cable diagnostics
- A function block library for MELSEC MEDOC *plus* makes the configuration of TCP/IP links quick and easy.

Specifications	A1SJ71QE71-B2	A1SJ71QE71-B5
Module type	Client / server	Client / server
Communications method	ETHERNET: CSMA/CD	ETHERNET: CSMA/CD
Interface	type 10BASE2	10BASE5
Communications data	transfer rate Mbit/s	10
	transfer type	Base band
	max. network length m	925
	max. segment length m	185
	nodes	30
	min. distance between 2 nodes m	0.5
Data buffer	fixed send/receive buffer	1 k words x 8
	variable buffer	6 k words
Simultaneous connections	8 + 1 FTP connection	8 + 1 FTP connection
Transport protocol	TCP/IP with ARP, UDP/IP	TCP/IP with ARP, UDP/IP
I/O points	32	32
Internal power consumption (5 V DC)	mA 800	600
Weight	kg 0.28	0.27
Dimensions (W x H x D)	mm 34.5 x 130 x 93.6	34.5 x 130 x 93.6
Order information	Art. no. 66550	66546
Accessories	—	—



MELSECNET/10 Network

Data communications

MELSECNET/10 enables extremely fast cyclic data exchange between the MELSEC PLCs of the AnSH, QnS, AnA/U and QnA series. It can also be used to connect remote I/O modules to these controllers. You can connect up to 255 individual MELSECNET/10 networks to one another. An integrated routing function makes it very easy to pass data from one network to another.

Structure

The ring structure of MELSECNET/10 enables very large network coverage of up to 30 km.

Cable types

MELSECNET/10 gives you a wide choice of cable types and topologies:

- Coaxial bus (max. 500 m)
- Coaxial duplex loop (max. 30 km)
- Fibre-optics duplex loop (max. 30 km)

Data exchange

Efficient cyclic data exchange is ensured with an exceptionally large data volume of 8192 words and 8192 relays.

Administration

MELSECNET/10 enables you to program and monitor every PLC in the system from any station.

The Floating Master architecture ensures reliable network operation even if the network manager fails.

Special features

In parallel to the cyclic data exchange it is also possible for any station to send data to and read data from any other station, even across several networks. The system also supports multicast and broadcast functions.

In MELSECNET/10 systems you only have to set parameters for the network manager, making installation very quick and simple.

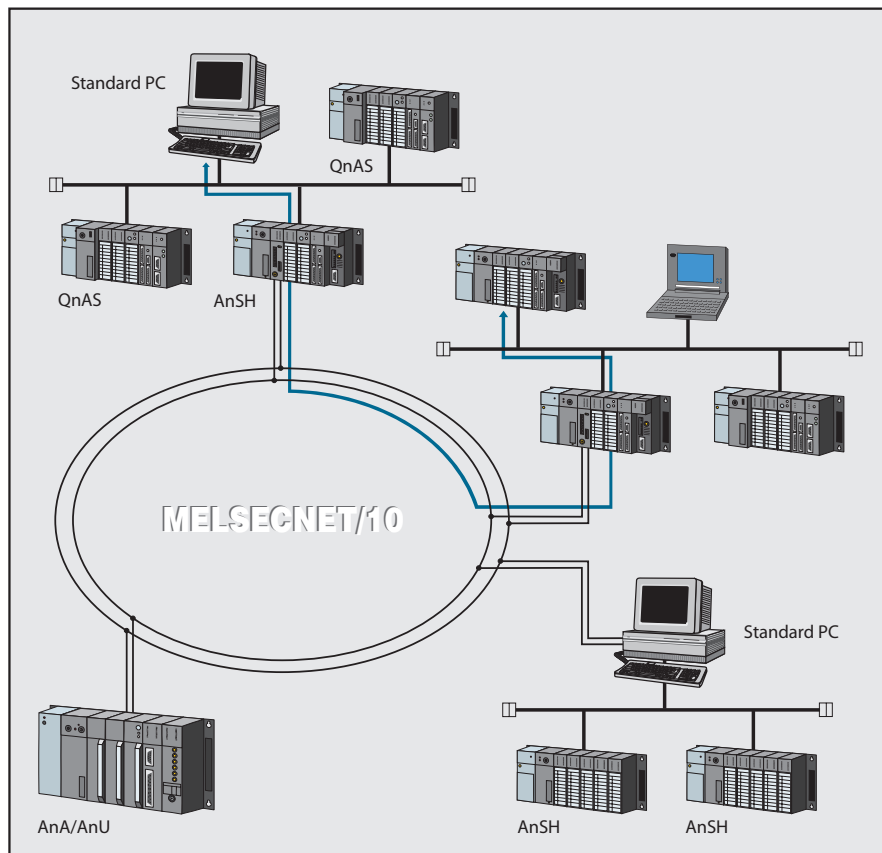

Specifications		Electrical		Optical		
Cable type		Coaxial bus	Coaxial duplex loop	Glass fibre SI185/230 μm	Glass fibre GI50/125 μm	Glass fibre GI62.5/125 m
Data transfer	rate	Mbit/s	10	10 (20)	10 (20)	10 (20)
	distance between 2 stations	m	—	500	1 000	2 000
	total coverage	m	≤500 (2500)	≤30000	≤30000	≤30000
Media	impedance (100 kHz)	Ω	75	75	—	—
	transmission losses	—	—	≤5.5 dB / km	≤3 dB / km	≤3 dB / km
	transmission bandwidth	—	—	≥20 MHz / km	≥300 MHz / km	≥300 MHz / km
Connectors						
Connection system		RG59	RG59	CA7003	CA9003S	CA9003S
Order information						
Art. no.		—	—	69365	29603	29603

Cable type	Layout	Max. length	Order information	Art. no.
SI cable	Connection plugs at both ends; 2-conductor type for interior installation; simple cable protection	Fixed length 2 m	AS-2P-2M-A	126228
		Fixed length 5 m	AS-2P-5M-A	62430
		Fixed length 30 m	AS-2P-30M-A	52353
		Fixed length 50 m	AS-2P-50M-A	62457
GI cable GI62,5/125 μm	Connection plugs at both ends; 2-conductor type for interior installation; simple cable protection	Fixed length 5 m	AGS-2P-05 M-625A	104330
GI cable GI50/125 μm		Fixed length 5 m	AG-2P-5M-A	38784
GI cable GI50/125 μm		Fixed length 4 m	AGS-CS-4M-50A	58630
GI cable GI62,5/125 μm		Fixed length 3 m	AGS-CS-3M-625A	58632
	Fixed length 4 m	AGS-CS-4M-625A	58631	

MELSEC AnS MELSECNET/10 Modules

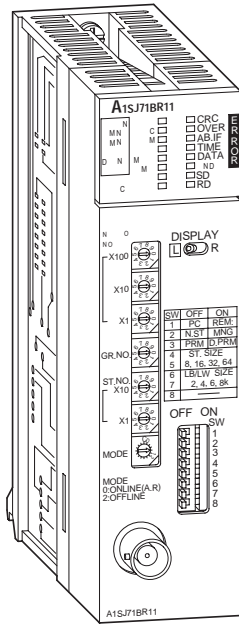

Reliable and flexible communications

MELSECNET/10 is the most powerful MELSEC network, supporting both high-speed cyclic communications and powerful acyclic communications functions.

Special features:

- High data transfer rate (10 Mbits/s) with coaxial bus systems and optional 10/20 Mbits/s with optical loop systems
- The A1SJ71 BR11 and A1SJ71LP21(GE) modules can be used for:
 - PLC ↔ PLC, PC data communications
 - PLC ↔ remote I/O control
- Floating Master technology guarantees trouble-free operation no matter which station in the system is powered down.
- Up to four MELSECNET/10 modules can be installed in a single PLC, handling routing functions across up to as many as 255 networks.
- The network system supports data communications between any two stations no matter how many networks lie between them.
- Large data volumes via link devices for cyclic data communications.

Specifications	A1SJ71BR11	A1SJ71LP21	A1SJ71LP21GE	
Module type	Manager / local stations	Floating Master	Floating Master	
Communications method	Token bus	Token ring	Token ring	
Topology	Coaxial bus system	Redundant optical loop system	Redundant optical loop system	
Synchronisation	Frame synchronisation method	Frame synchronisation method	Frame synchronisation method	
Transmission channel	Single bus	Redundant loop	Redundant loop	
Link registers	8192 (0 – 1FFF)	8192 (0 – 1FFF)	8192 (0 – 1FFF)	
Max. cyclic data for link in one station	≤ 2000 bytes	≤ 2000 bytes	≤ 2000 bytes	
Modulation method	Manchester	NRZI	NRZI	
Transmission format	Conforms to HDLC	Conform to HDLC	Conforms to HDLC	
Terminating resistor	Ω 75	—	—	
No. of networks in one system	Max. 255	Max. 255	Max. 255	
Stations per network	32 (1 manager, 31 local stations)	64 (1 manager, 63 local stations)	64 (1 manager, 63 local stations)	
Groups (multicast)	Max. 9	Max. 9	Max. 9	
Transmission	rate Mbit/s	10	10 (20)	
	distance	300 m / 500 m (depends on cable used)	SI 200/220: 500 m, QSI 185/230: 1000 m	GI 62.5/125: 2000 m
	cable	RG59 BU / RG6 AU	—	—
	connectors	BNC-P-3-Ni / BNC-P-5	CA7003	CA7003S
Max. compensation time during power failure	ms ≤ 20	≤ 20	≤ 20	
I/O points	32	32	32	
Internal power consumption (5 V DC)	mA 800	650	650	
Weight	kg 0.33	0.33	0.33	
Dimensions (W x H x D)	mm 34.5 x 130 x 93.6	34.5 x 130 x 93.6	34.5 x 130 x 93.6	
Order information	Art. no. 47869	47868	53457	
Accessories	Terminating resistor: BNC-75 OHM, art. no.: 53871	Optical duplex plug for SI cable: CA7003, art. no. 9546 Optical duplex plug for GI cable: CA9003S, art. no. 29603 Optical SI cable: 2 m: AS-2P-2M-A, art. no. 126228, 5 m: AS-2P-5M-A, art. no. 62430, 30 m: AS-2P-30M-A, art. no. 52353, 50 m: AS-2P-50M-A, art. no. 62457; up to 1000 m on request Optical GI cable: fibre optics GI62.5/125 mm; AGS-GS-3M-625A, art. no. 58632 fibre optics GI62.5/125 mm; AGS-GS-4M-625A, art. no. 58631		



■ MELSEC QnAS MELSECNET/10 Modules

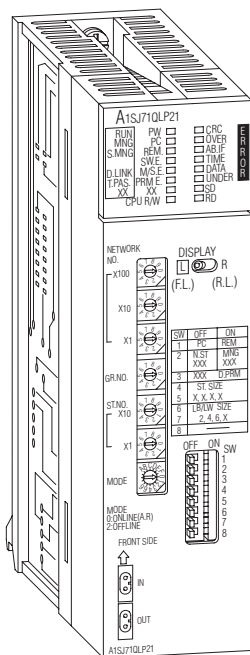

Reliable and flexible communications

MELSECNET/10 is the most powerful MELSEC network, supporting both high-speed cyclic communications and powerful acyclic communications functions. The extremely high-speed data access performance of the QnAS CPUs guarantees very short response times in communications between two controllers.

Special features:

- High data transfer rate (10Mbits/s) with coaxial bus systems and optional 10/20Mbits/s with optical loop systems
- The modules can be used for:
 - PLC ↔ PLC, PC data communications
 - PLC ↔ remote I/O control
- Otherwise these modules have the same features as the modules on the previous page, plus they can also be used for the configuration of a redundant master system for remote I/Os in MELSECNET/10.

Specifications	A1SJ1QBR11	A1SJ1QLR21	A1SJ1QLP21
Module type	Floating master	Floating master	Floating master
Communications method	Token bus	Token ring	Token ring
Topology	Coaxial bus system	Coaxial bus system	Optical loop system
Synchronisation	Frame synchronisation method	Frame synchronisation method	Frame synchronisation method
Transmission channel	Single bus	Redundant loop	Redundant loop
Link register	8192 (0 – 1FFF)	8192 (0 – 1FFF)	8192 (0 – 1FFF)
Max. cyclic data for link in one station	≤ 2000 bytes	≤ 2000 bytes	≤ 2000 bytes
Modulation method	Manchester	Manchester	NRZI
Transmission format	Conforms to HDLC	Conforms to HDLC	Conforms to HDLC
Terminating resistor	Ω 75	75	—
No. of networks in one system	255	255	255
Stations per network	32 (1 manager, 31 local stations)	64 (1 manager, 63 local stations)	64 (1 manager, 63 local stations)
Groups (multicast)	Max. 9	Max. 9	Max. 9
Transmission	rate	Mbit/s 10	10 (acc. to 20 multiplex)
	distance	m 300 m / 500 m (depends on cable used)	300 m / 500 m (depends on cable used)
	cable	RG59 BU / RG6 AU	RG59 BU / RG6 AU
	plug	BNC-P-3-Ni / BNC-P-5	BNC-P-3-Ni / BNC-P-5
Max. compensation time during power failure	ms ≤ 20	≤ 20	≤ 20
I/O points	32	32	32
Internal power consumption (5 V DC)	mA 800	650	650
Weight	kg 0.3	0.3	0.3
Dimensions (W x H x D)	mm 34.5 x 130 x 93.6	34.5 x 130 x 93.6	34.5 x 130 x 93.6
Order information	Art. no. 66540	128797	66541
Accessories	Terminating resistor: BNC-75 OHM, art. no.: 53871	Terminating resistor: BNC-75 OHM, art. no.: 53871	Optical duplex plug for SI cable: CA7003, art. no. 69365 Optical SI cable: 2 m: AS-2P-2M-A, art. no. 126228, 5 m: AS-2P-5M-A, art. no. 62430, 30 m: AS-2P-30M-A, art. no. 52353 50 m: AS-2P-50M-A, art. no. 62457; up to 1000 m on request

MELSEC QnAS MELSECNET/10 Module

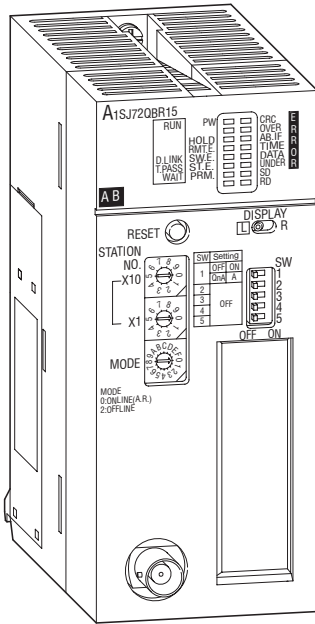

Complex remote Inputs/Outputs

Enables fast and cost-effective connection of extremely complex remote I/Os to a host PLC CPU in MELSECNET/10 networks.

Special features:

- Enables configuration of very complex remote inputs and outputs with:
 - Digital I/Os
 - Analog I/Os
 - Positioning modules
 - Communications modules (ETHERNET/Computer Link)
 - Etc.
- Supports definition of a Standby Master for remote I/Os in MELSECNET/10 networks (only with AnS and QnAS series CPUs).
- The Master CPU can be programmed and monitored from the remote module.
- Installation on the main base unit in the place of the PLC CPU.

Specifications	A1SJ720BR15	A1SJ72QLP25	
Module type	Slave	Slave	
Communications method	Token bus	Token ring	
Topology	Coaxial bus system	Optical loop system	
Synchronisation	Frame synchronisation method	Frame synchronisation method	
Transmission channel	Single bus	Redundant loop	
No. of I/Os in a network	Max. 8192	Max. 8192	
No. of data per slave	Max. 1600 bytes	Max. 1600 bytes	
Modulation method	Manchester	NRZI	
Transmission format	Conforms to HDLC	Conforms to HDLC	
Terminating resistor	Ω 75	—	
No. of networks in one system	255	255	
Stations per network	33 (1 manager, 32 local stations)	64 (1 manager, 63 local stations)	
Transmission	rate	Mbit/s 10	10 (20)
	distance	m 300 m / 500 m (depends on cable used)	SI 200/220: 500 m, QSI 185/230: 1000 m
	cable	RG59 BU / RG6 AU	—
	plug	BNC-P-3-Ni / BNC-P-5	CA7003
Max. compensation time during power failure	ms ≤ 20	≤ 20	
I/O points	—	—	
Internal power consumption (5 V DC)	mA 700	520	
Weight	kg 0.43	0.41	
Dimensions (W x H x D)	mm 54.5 x 130 x 93.6	54.5 x 130 x 93.6	
Order information	Art. no. 68450	68449	
Accessories	Terminating resistor: BNC-75 OHM, art. no.: 53871	Optical duplex plug for SI cable: CA7003, art. no. 69365 Optical SI cable: 2 m: AS-2P-2M-A, art. no. 126228, 5 m: AS-2P-5M-A, art. no. 62430, 30 m: AS-2P-30M-A, art. no. 52353 50 m: AS-2P-50M-A, art. no. 62457; up to 1000 m on request	



■ Interface Boards for MELSECNET/10

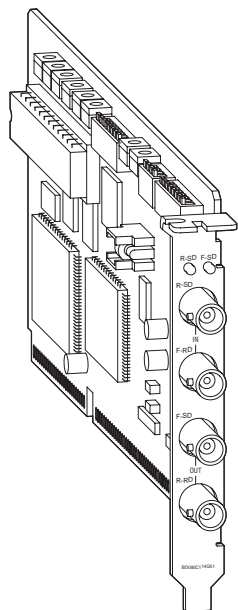

Interface boards for MELSECNET/10

These interface boards enable you to integrate personal computers into a MELSECNET/10-Netzwerk.

Special features:

- Fast data rates between the personal computer and the programmable logic controller (faster than ETHERNET)
- The PC can access all other CPUs, even across multiple networks (integrated routing function)
- Perfect for PLC programming at MELSECNET/10
- Ideal for data and program archiving
- Up to 4 interface boards can be installed in each personal computer.

Specifications		A70BDE-J71QLP23	A70BDE-J71QLP23GE	A70BDE-J71QLR23	A70BDE-J71QBR13
Module type		Local station	Local station	Local station	Local station
Transmission method		Duplex loop	Duplex loop	Duplex loop	Single bus
Transmission path		Token ring	Token ring	Token ring	Token bus
Synchronisation method		Frame synchronisation method	Frame synchronisation method	Frame synchronisation method	Frame synchronisation method
Modulation		NRZI (Non Return to Zero Inverted)	NRZI (Non Return to Zero Inverted)	Manchester	Manchester
Link points per connection		$2 \times W + (B+Y)/8 \leq 2000$ bytes	$2 \times W + (B+Y)/8 \leq 2000$ bytes	$2 \times W + (B+Y)/8 \leq 2000$ bytes	$2 \times W + (B+Y)/8 \leq 2000$ bytes
Link devices		8192 link relays / registers	8192 link relays / registers	8192 link relays / registers	8192 link relays / registers
Transmission format		Conforms to HDLC	Conforms to HDLC	Conforms to HDLC	Conforms to HDLC
Max. link points in one system		Max. 239	Max. 239	Max. 239	Max. 239
Stations per network		Max. 64	Max. 64	Max. 64	Max. 32
Max. number of local station groups		9	9	9	9
Transmission	type/medium	Optical (SI 200/220, QSI 185/230)	Optical (GI 62.5/125)	Electrical	Electrical
	rate	Mbit/s	10 / acc. to 20 multiplex	10 / acc. to 20 multiplex	100
	distance between 2 stations	m	SI 200/220: 500 m, QSI 185/230: 1000 m	GI 62,5/125: 1000 m	3C-2V: 300 m, 5C-2V: 500 m, 2500 with Repeater
	cable		Fibre optics	Fibre optics	Coaxial cable
	connectors		CA7003 for SI cable, CA7003 for QSI cable	CA9103S for GI cable	BNC-P-5 / BNC-P-3-NI or equivalent
Error detection		CRC based and overflow	CRC based and overflow	CRC based and overflow	CRC based and overflow
Boards per PC		Max. 4	Max. 4	Max. 4	Max. 4
Internal current consumption (5 VDC)		A	1.3	1.3	1.3
Weight		kg	0.5	0.5	0.5
Dimensions		mm	ISA bus board	ISA bus board	ISA bus board
Order information		Art. no. 126888	126887	128856	126889
Accessories		Optical fibre cable, SI type	5 m: AS-2P-5M-A, art. no. 62430; 30 m: AS-2P-30M-A, art. no. 52353; 50 m: AS-2P-50M-A, art. no. 62457; up to 1000 m on request	Terminating resistor: BNC-75 OHM, art. no.: 53871	

The MELSECNET(II) Network

Data communications

MELSECNET(II) enables cyclic data exchange between personal computers and MELSEC programmable logic controllers of the AnSH, QnAS, AnA/U and QnA series. The network also supports the integration of remote I/O modules. A subordinate MELSECNET(II) or MELSECNET/B network can be connected to a MELSECNET(II) configuration.

Structure

The loop architecture of MELSECNET(II) enables the configuration of large networks with a coverage of up to 10 km.

Cable type

The network supports two different cable types:

- Coaxial duplex loop (max. 10 km)
- Fibre-optics duplex loop (max. 10 km)

Data exchange

The network supports a large cyclic data exchange volume of 1024 (4096) words and 1024 (4096) relays.

Administration

In parallel to the cyclic data exchange you can also program and monitor every slave PLC in the system from the master PLC. The Master/Slave procedure ensures extremely efficient network management. Cable breaks are registered automatically and continued operation is ensured by the redundant data cable.

Special features

MELSECNET(II) is very simple to install. The only parameters that need to be entered are in a table for the master station specifying the data available for the cyclic data exchange process.

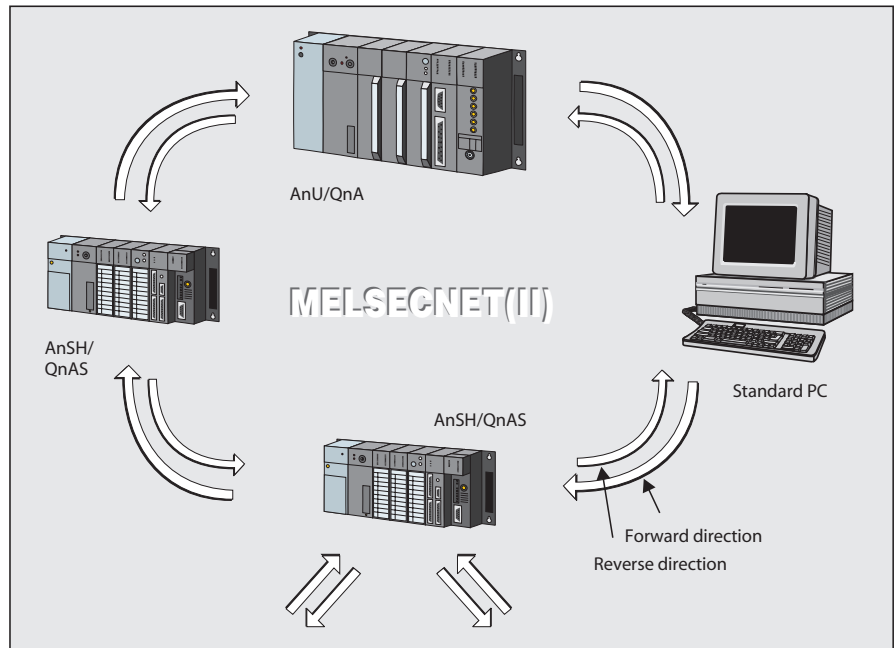

Data		Electrical	Optical		
Cable type		Coaxial duplex loop	Glass fibre SI200/250 μm	Glass fibre GI50/120 μm	Glass fibre GI62,5/125 μm
Transmission	rate	Mbit/s	1.25	1.25	1.25
	distance between 2 stations	m	500	1000	2000
	total coverage	m	≤10000	≤10000	≤10000
Media	impedance (100 kHz)	Ω	75	—	—
	transmission losses	—	≤5.5 dB / km	≤3 dB / km	≤3 dB / km
	transmission band width	—	≥20 MHz / km	≥300 MHz / km	≥300 MHz / km
Connectors					
Connection system		RG59	CA7003	CA9003S	CA9003S
Order information		Art. no.	—	69365	29603

Cable type	Layout	Max. length	Order information	Art. no.
SI cable	Connection plugs at both ends; 2-conductor type for interior installation; simple cable protection	Fixed length 2 m	AS-2P-2M-A	126228
		Fixed length 5 m	AS-2P-5M-A	62430
		Fixed length 30 m	AS-2P-30M-A	52353
		Fixed length 50 m	AS-2P-50M-A	62457
GI cable GI62,5/125 μm	Connection plugs at both ends; 2-conductor type for interior installation; simple cable protection	Fixed length 5 m	AGS-2P-05 M-625A	104330
GI cable GI50/125 μm		Fixed length 5 m	AG-2P-5M-A	38784
GI cable GI50/125 μm		Fixed length 4 m	AGS-CS-4M-50A	58630
GI cable GI62,5/125 μm	Adapter cable from Hitachi CA9103S plug – ST plug	Fixed length 3 m	AGS-CS-3M-625A	58632
		Fixed length 4 m	AGS-CS-4M-625A	58631

MELSECNET(II) Modules

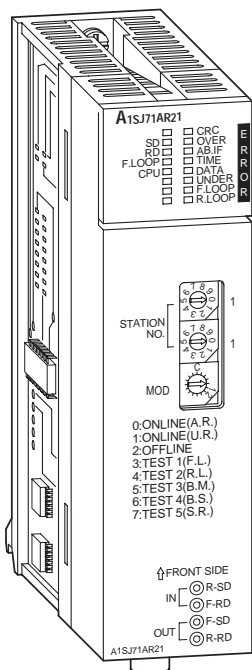

Communication with redundant coaxial cable

MELSECNET(II) permits a dual communication line. One is in the standby mode and maintains the communication in the event of an error on the active line (cable break).

Special features:

- Ring topology with coaxial or optical cable as transmission line
- Very simple start-up of cyclic and acyclic communication
- Loopback function in the event of failure of a local station
- Central programming and program monitoring of all stations in the network
- Extensive diagnostics facilities via peripherals or internal register

Specifications	A1S71AR21	A1S71AP21
Module type	Master / slave	Master / slave
Communications method	Half duplex	Half duplex
Synchronisation	Frame synchronisation method	Frame synchronisation method
Transmission channel	Duplex loop	Duplex loop
Link register	4096 (0 – FFF)	4096 (0 – FFF)
Max. cyclic data for link in one station	≤ 2 048	≤ 2048
Stations per network	65 (1 master/64 slaves)	65 (1 master/64 slaves)
Modulation method	CMI	CMI
Transmission format	Conforms to HDLC	Conforms to HDLC
Remote I/O points	512	512
Transmission rate	Mbit/s 1.25	1.25
Transmission distance	m 500, max. total length 10000	1000, max. total length 10000
Cable type	RG59B/U	SI200/250µm
Max. compensation time during power failure	ms ≤ 10	≤ 10
I/O points	32	32
Internal power consumption (5 V DC)	mA 630	330
Weight	kg 0.33	0.3
Dimensions (W x H x D)	mm 34.5 x 130 x 93.6	34.5 x 130 x 93.6
Order information	Art. no. 42069	42323
Accessories	Optical fibre cable with attached connectors; SI type: 2 m: AS-2P-2M-A, art. no. 126228, 5 m: AS-2P-5M-A, art. no. 62430; 30 m: AS-2P-30M-A, art. no. 52353; 50 m: AS-2P-50M-A, art. no. 62457; up to 1000 m on request	

Interface Boards for MELSECNET (II)

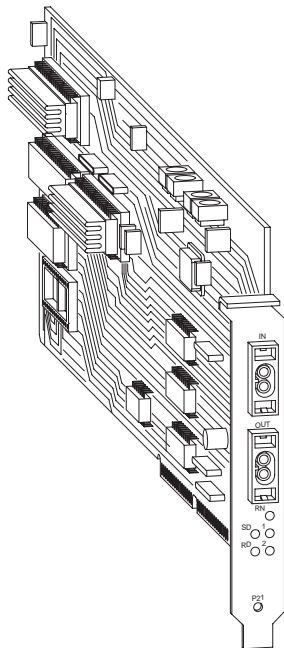

Interface boards for MELSECNET (II)

These interface boards enable you to integrate personal computers into a MELSECNET (II) network.

Special features:

- Very high-speed data rates between personal computers and controller, faster than ETHERNET
- Access to all data in the entire network
- The PC can access all other CPUs
- Available for both coaxial and fibre-optics cables

Specifications		A7BDE-J71AP21	A7BDE-J71AR21
Module type		Master / slave	Master / slave
Transmission method		Half duplex, bit serial	Half duplex, bit serial
Max. link points in one system		4.096 link relay / register	4.096 link relay / register
Transmission format		Conforms to HDLC	Conforms to HDLC
Demodulation method		CMI	CMI
Number of linkable networks		Max. 65	Max. 65
Stations per network		1 Master, up to 64 slaves	1 Master, up to 64 slaves
Transmission	rate	Mbit/s 1.25	1.25
	distance between 2 stations	m Max. 1000; overall max. 10000	Max. 500; overall max. 10000
	cable	Fibre-optics cable	Coaxial cable
	type	SI200 / SI250 μ m	RG59 BU / RG6 AU
	connector	CA9003	BNC-P-5 / BNC-P-3-NI
Boards per PC		1	1
Internal current consumption (5 V DC)	A	0.9	1.3
Weight	kg	0.4	0.4
Dimensions (W x H x D)	mm	362 x 143 x 30 (long AT-bus slot)	362 x 143 x 30 (long AT-bus slot)
Order information	Art. no.	29622	29621
Accessories	Device driver and test software: SW1-IM-M NET, art. no. 32191 Optical fibre cable with attached connectors; SI type: 2 m: AS-2P-2M-A, art. no. 126228, 5 m: AS-2P-5M-A, art. no. 62430; 30 m: AS-2P-30M-A, art. no. 52353; 50 m: AS-2P-50M-A, art. no. 62457; up to 1000 m on request		



The MELSECNET/B Network

Data communications

MELSECNET/B is an extremely cost-effective network, providing cyclic data communication for MELSEC AnSH, QnAS, AnU and QnA controllers. You can also integrate remote I/O modules in the network. A lower-level MELSECNET(II) or MELSECNET/10 network can be connected to a MELSECNET/B configuration.

Structure

The bus cable can be up to 1200 m long, depending on the data transfer rate. Up to 32 stations can be connected to one network.

Cable type

This network type uses shielded twisted-pair cabling as the data transfer medium (2 pairs).

Data exchange

MELSECNET/B's cyclic data exchange provides an excellent data volume of 1024 (4096) words and 1024 (4096) relays, depending on the master PLC used: 1024 relays and words with the CPU types A1S, A1S-S1, A2S, and 4096 relays and words with all other CPU types.

Administration

In parallel to the cyclic data exchange you can also program and monitor every slave PLC in the system from the master PLC. The Master/Slave procedure ensures extremely efficient network management.

Special features

MELSECNET/B is very simple to install. The only parameters that need to be entered are in a table for the master station specifying the data available for the cyclic data exchange process.

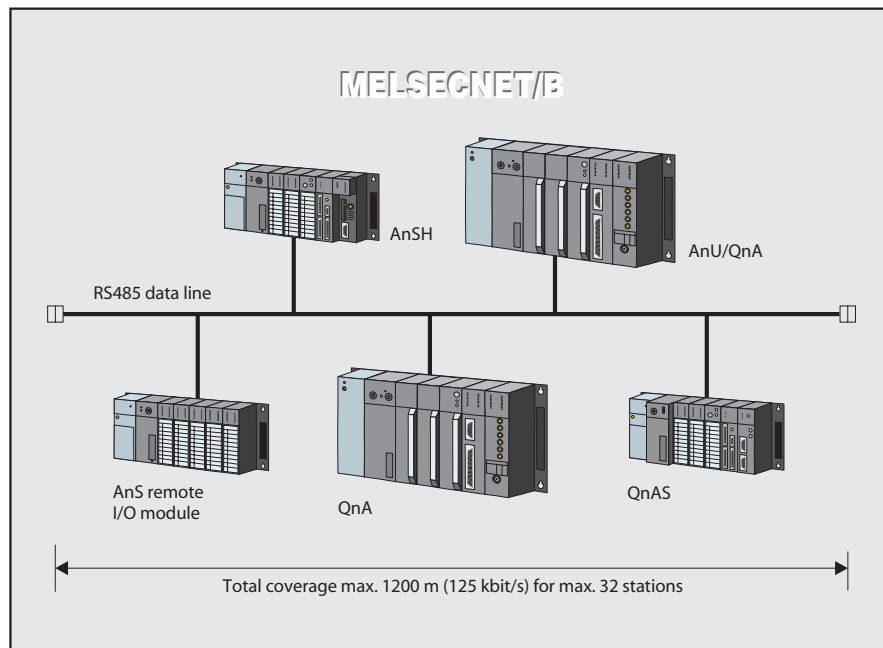

Interface	RS485
Cable type	Shielded twisted-pair
No. of pairs	2
DC resistance	39.4 Ω / km
Insulation resistance (20°C)	10 MΩ / km
Electrostatic capacity (1kHz)	70 nF / m or less
Impedance (100 kHz)	110 Ω ±10 Ω

Cable recommendation: Lappkabel Unitronic-Li2YCYv(TP)/AWG20 2x2x0,50

MELSECNET/B Module

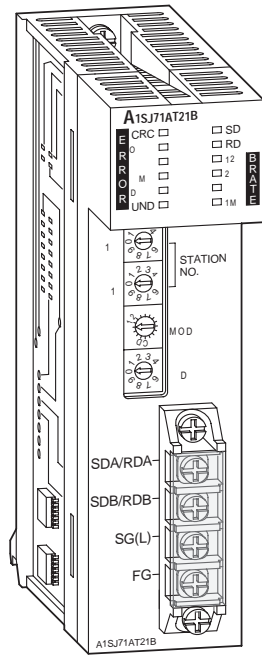

Communication with economical two-wire line

MELSECNET/B makes it possible to establish an integrated system of up to 32 MELSEC PLC systems via an RS485 interface.

Special features:

- Bus topology with shielded two-wire line as transmission medium
- Very simple start-up of cyclic and acyclic communication
- Automatic data exchange with MELSECNET(II) and MELSECNET/10 possible
- Central programming and program monitoring of all stations in the network
- Extensive diagnostics facilities via peripherals or internal register
- Remote I/Os can be connected to the network by installing the module A1SJ72T25B as a slave in the PLC CPU location of the main base unit.

Specifications	A1SJ71AT21B	A1SJ72T25B
Module type	Master / slave	Slave (remote I/O link module)
Communications method	Half duplex	Half duplex
Topology	Bus	Bus
Synchronisation	Frame synchronisation method	Frame synchronisation method
Link register / bus	4096 (0 – FFF)	4096 (0 – FFF)
Max. cyclic data for link in one station	≤ 2048	≤ 2048
Stations per network	32	32
Modulation method	NRZI	NRZI
Transmission format	Conforms to HDLC	Conforms to HDLC
Remote I/O points	512	512
rate	kbit/s 125 / 250 / 500 / 1000	125 / 250 / 500 / 1000
Transmission distance	m 1200 / 600 / 400 / 200 (depends on the transmission rate)	1200 / 600 / 400 / 200 (depends on the transmission rate)
cable	Shielded twisted-pair	Shielded twisted-pair
Max. compensation time during power failure	ms ≤ 20	≤ 20
I/O points	32	—
Internal power consumption (5 V DC)	mA 660	660
Weight	kg 0.22	0.4
Dimensions (W x H x D)	mm 34.5 x 130 x 93.6	54.5 x 130 x 93.6
Order information	Art. no. 25723	47871



The CC-Link Network

Data communications

The MELSEC CC-Link network provides fast data communications with different devices. The following components among others can be integrated:

- Remote digital inputs/outputs
- Remote analogue inputs/outputs
- High-speed counters
- Positioning modules
- Modules for temperature measurement
- Distributed intelligence (e.g. FX2N)
- Frequency inverters (e.g. FR-A 540)
- Operator terminals (e.g.. GOT)
- Third party devices like gateways, solenoid valves, barcode readers, etc.

Structure

The maximum bus segment extension is 1,200 m (at 156 kbit/s max.). With a reduced extension, transfer rates of up to 10 Mbit/s can be achieved.

Cable types

The data communications requires standardized shielded twisted-pair cable.

Data exchange

Various data like digital and analogue data can be exchanged easily. In addition to the cyclic transmission of word data, CC-Link systems handle transient transmission (message transmission) as well. This enables data communication with intelligent devices such as display devices, bar code readers, measuring devices, and personal computers.

Administration

The programming software packages MELSEC MEDOC *plus* and MELSEC MEDOC GPP/WIN ensure an easy setup and commissioning.

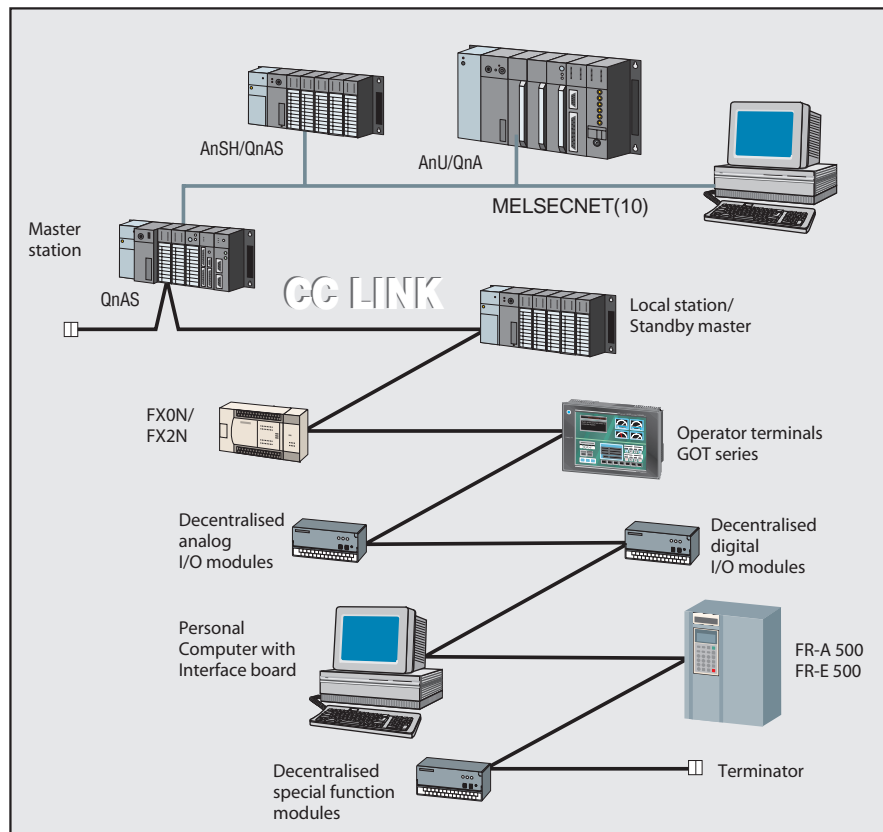

Various special features provide a particular economic network administration:

- Automatic online return function after the removal of a unit from the network.
- Stand-by master function for redundancy across the system.
- Automatic link cutoff function of a faulty slave station without interrupting network communications.
- Link status confirmation.
- Extensive test and diagnostics functions.

Cabel	Shielded twisted-pair
Diameter	0,5 mm ² (1 pair)
Cable resistance (20 °C)	≤37,8 Ω / km
Electrostatic capacity (1kHz)	60 nF / km
Impedance (1 MHz)	100 Ω ±15 %
Insulation resistance	≥10.000 MΩ / km
Voltage withstand	500 V DC for 1 minute
Maximal distance	1.200 m

■ CC-Link Master Module

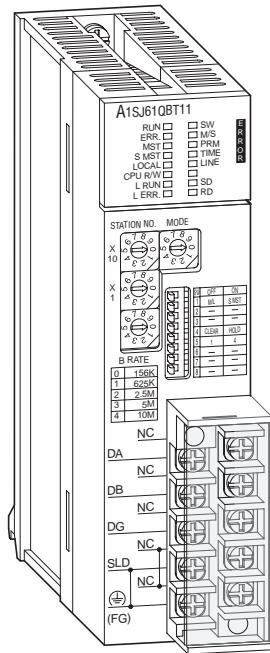

Connection of remote inputs/outputs

The CC-Link enables the control and monitoring of I/O modules on a remote machine. The data is transferred to the central controllers via the master module.

Special features:

- The parameters of all modules across the network are set directly via the master module.
- The communication between the remote modules and the master module is performed automatically (refresh rate of up to 3.9 ms for 2048 I/O points).
- With one master module a system can be extended by up to 2048 remote I/O points.
- An additional stand-by master establishes a duplex system.
- Automatic link cutoff function of a faulty slave station without interrupting network communications.
- Automatic online return of a station after error corrective action without network reset.
- Data transfer via shielded twisted pair cable.

Specifications		A1SJ61BT11	A1SJ61QBT11
Module type		Master / Local Station	Master / Local Station
CPU series		MELSEC AnS series	MELSEC QnAS series
Link points per station	I/O points	32	
	register	8	
Decentral I/O points		2048	
Number of connectable modules		Max. 64 (Remote I/O modules: max. 64; Remote special function modules: max. 42; local stations: max. 24)	
I/O refresh time		ms	3.9 – 6.7
Transmission	speed	Mbit/s	10; 5; 2.5; 0.62; 0.15
	type		Bus
	distance	m	100 m at 10 Mbit/s; 150 m at 5 Mbit/s; 200 m at 2.5 mbit/s; 600 m at 0,62 Mbit/s; 1200 m at 0.15 Mbit/s
	total distance	m	Max. 1200m
Synchronizations method		Frame synchronisation	
Modulation		NRZI	
Transmission route type		Bus (RS485)	
Transmission format		HDLC	
Transmission cable	type	Shielded twisted-pair	
	no. of cores	2	
	cable resistance (20 °C)	Max. 37.8 Ω/km	
	insulation resistance (1 kHz)	Max. 60 nF/km	
	characteristic impedance (100 kHz)	100 ±15Ω	
	cable resistance (20 °C)	10000 MΩ/km	
		diameter	0.5 mm ²
I/O points		32	
Internal power consumption (5 V DC)		mA	400
Weight		kg	0.25
Dimensions (W x H x D)		mm	37.5 x 130 x 93.6
Order information		Art. no.	75497 126738
Accessories		Programming software: MELSEC MEDOC <i>plus</i> or MELSEC MEDOC GPP/WIN (see page 92)	



■ CC-Link Remote Digital Input and Combination Modules

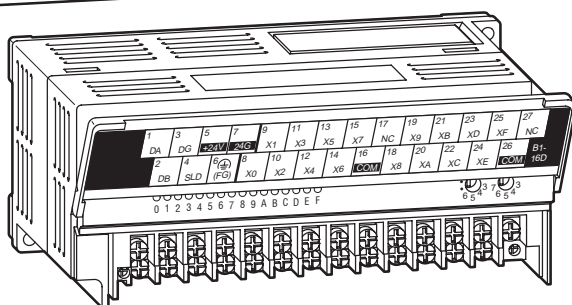
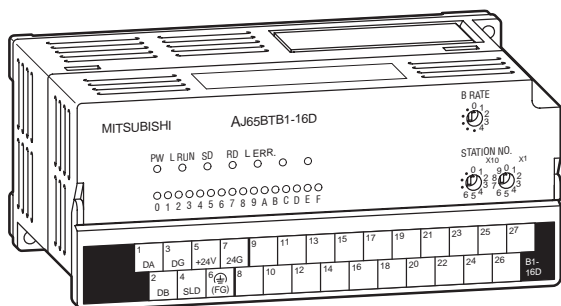

Remote inputs

The remote input modules acquire the signals within short distance from the machine. The advantage is a reduced cabling requirement and the capability of acquiring data and operation results of individual machine modules autonomously, electrically, and mechanically.

Besides three different input modules with up to 32 inputs, a combined module with 8 inputs and 8 outputs is available.

Special features:

- Up to 64 I/O modules with a maximum of 32 inputs each can be connected.
- All modules are very compact.
- Tough, highly shock-resistant pattern.
- Status indicator LEDs for the inputs.
- Standard electrical isolation between process and control via optocouplers.
- Mounting with DIN rail adapters or screws.
- Modules can be mounted in horizontal arrangement or in one of 4 orientations on a flat surface.

Specifications	AJ65BTB1-16D	AJ65BTB2-16D	AJ65BTC1-32D	AJ65BTB1-16DT
Module type	Input modules			Combination module
Inputs	16	16	32	8
Outputs	—	—	—	8
Input type	DC input (sink / source type)	DC input with 8 potential terminals (sink / source type)	DC input (sink / source type)	DC input (sink type)
No. of points per module	16	16	32	8
Output type	—	—	—	Transistor
No. of points per module	—	—	—	8
Insulation type	All modules feature photocoupler insulation.			
Input voltage	24 V DC	24 V DC	24 V DC	24 V DC
Input current	mA 7	7	7	7
Max. output current	per output —	—	—	0,5
	per group —	—	—	4
Damping voltage	ON voltage V ≥ 14	≥ 14	≥ 14	≥ 14
	OFF voltage V ≤ 6	≤ 6	≤ 6	≤ 6
Response time	OFF \rightarrow ON ms ≤ 2	≤ 2	≤ 2	≤ 10
	ON \rightarrow OFF ms ≤ 2	≤ 2	≤ 2	≤ 12
Status display of inputs	All modules provide LEDs for each input.			
Error (RUN) display of stations	LED	LED	LED	LED
I/O points	16	16	32	16
Connection terminals	Terminal block	Terminal block	Connector	Terminal block
Applicable wire size	mm ² 0.75 – 2.0	0.75 – 2.0	0.75 – 2.0	0.75 – 2.0
Internal power consumption	mA 60	60	70	70
Weight (without terminal block)	kg 0.32	0.4	0.27	0.33
Dimensions (W x H x D)	mm 151.9 x 65 x 46	197.4 x 65 x 46	165 x 65 x 46	151.9 x 65 x 46
Order information	Art. no. 75447	75450	75455	75448

■ CC-Link Remote Digital Output Modules

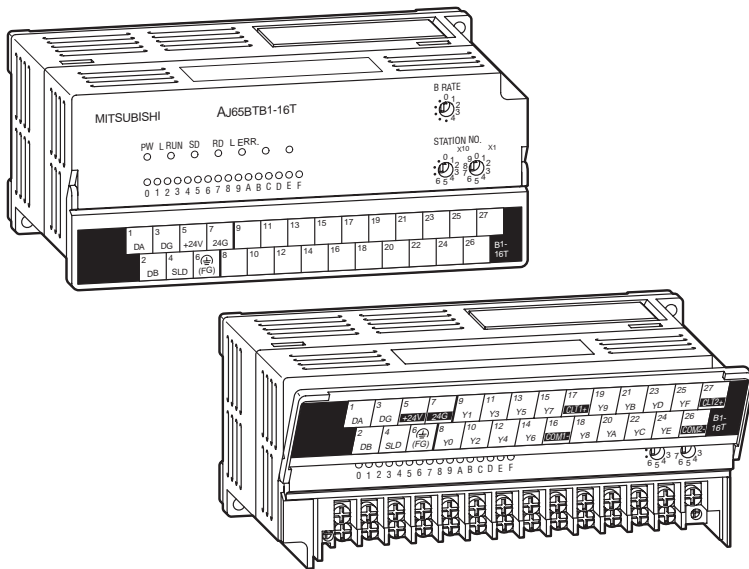

Remote outputs

The remote output modules output the signals within short distance to the machine. The advantage is a reduced cabling requirement and the capability of controlling and monitoring data and operation results of individual machine modules autonomously, electrically, and mechanically.

Special features:

- Up to 64 I/O modules with a maximum of 32 outputs each can be connected.
- All modules are very compact.
- Tough, highly shock-resistant pattern.
- Status indicator LEDs for the outputs.
- Standard electrical isolation between process and control via optocouplers.
- Mounting with DIN rail adapters or screws.
- Modules can be mounted in horizontal arrangement or in one of 4 orientations on a flat surface.

Specifications	AJ65BTB1-16T	AJ65BTC1-32T	AJ65BTB2-16R
Module type	Output modules		
Outputs	16	32	16
Output type	Transistor	Transistor	Relay
No. of points per module	8	32	8
Insulation type	All modules feature photocoupler insulation.		
Output rated voltage	12/24 V DC	12 /24 V DC	24 V DC 240 V AC
Max. output current	per output	0.5	0.1
	per group	A 4	2
Leak current output OFF			
Response time	OFF → ON	ms ≤2	≤2
	ON → OFF	ms ≤2	≤2
Overvoltage protection	Zener diode	Clamp diode	—
Status display of outputs	All modules provide LEDs for each output.		
Error (RUN) display of stations	LED	LED	LED
I/O points	16	32	16
Connection terminals	Terminal block	Connector	Terminal block
Applicable wire size	mm ² 0.75 – 2.0	0.75 – 2.0	0.75 – 2.0
Internal power consumption	mA 80	115	85
Weight (without terminal block)	kg 0.34	0.28	0.47
Dimensions (W x H x D)	mm 151.9 x 65 x 46	165 x 65 x 46	197.4 x 65 x 46
Order information	Art. no. 75449	75456	75453



■ CC-Link Remote Analog Output Modules

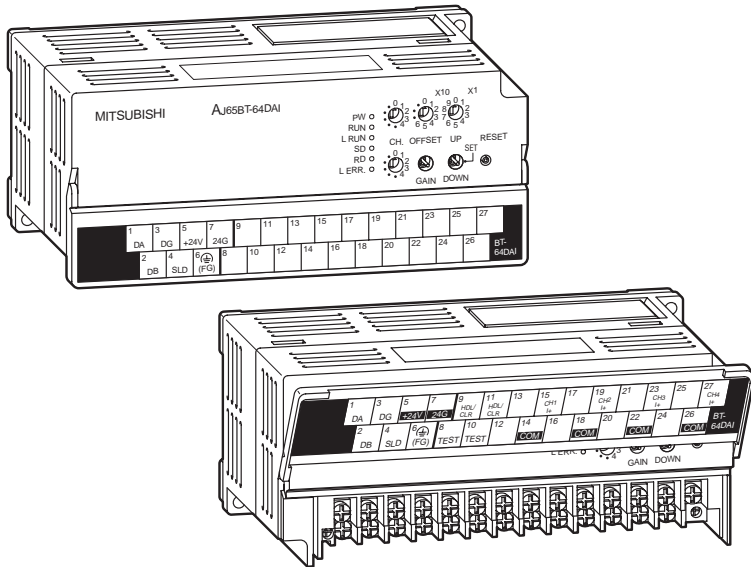

Digital to analog converter modules

These modules serve as remote 4-channels digital to analog converter modules with 12-bit or 13-bit binary resolution and output an analog current or voltage signal. With this signal for example, frequency inverters, valves or sliders can be controlled.

Special features:

- Up to 4 channels per module.
- Resolution of the digital input signals selectable in 3 steps: 1/4000, 1/8000, 1/12000.
- Gain and offset setting provided for each channel.
- Converting time of 1 ms per channel and 4 ms for 4 channels.
- Status indicator LEDs.
- Standard electrical isolation between process and control via optocouplers.
- Ready for use with all CC-Link master modules.



Specifications	AJ65BT-64DAV	AJ65BT-64DAI
Analog outputs	4	4
Resolution	12 bit, -2048 to +2.047	12 bit, 0 – 4095
Analog output	-10 V – 0 V – +10 V DC (external input resistance 2 kΩ – 1 MΩ)	4 – 20 mA DC (external input resistance 0 – 600 Ω)
I/O characteristics	Digital input	Digital input
	Analog output	Analog output
	Resolution	Resolution
	Voltage	Current
	2000	+10 V
	1000	+5 V
	0	0 V
	-1000	-5 V
	-2000	-10 V
Offset/Gain setting	Yes (users or factory setting)	Yes (users or factory setting)
Overall accuracy	±1.0 % (for the whole measurement range)	±1.0 % (for the whole measurement range)
Max. conversion time	Max. 1 ms/1 channel, 4 ms/4 channels	Max. 1 ms/1 channel, 4 ms/4 channels
Isolation method	All modules fitted with photocoupler isolation between input terminals and internal circuit.	
I/O points	2 stations (32 devices)	2 stations (32 devices)
Applicable wire size	mm ² 0.75 – 2.0	0.75 – 2.0
Internal power consumption (24 V DC)	mA 180	270
Weight	kg 0.4	0.4
Dimensions (W x H x D)	mm 152 x 65 x 63	152 x 65 x 63
Order information	Art. no. 75446	75445

■ CC-Link Remote Analog Input Modules for Pt100-Elements

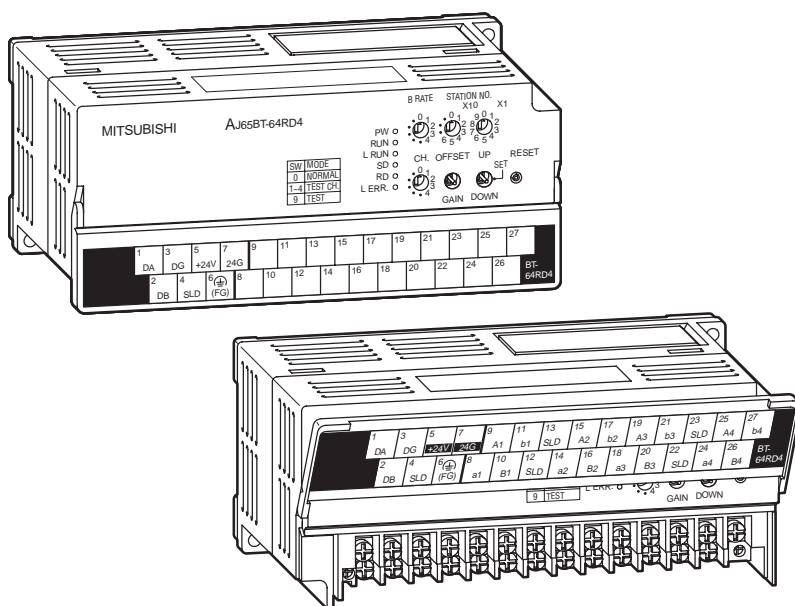

Connection of Pt100-elements

The analog modules AJ65BT-64RD3 and AJ65BT-64RD4 provide analog inputs for measuring values of Pt100 elements.

Special features:

- Linear measuring range without adjustment of the measuring values.
- Direct output of the measuring values in °C.
- Temperature measuring range of -180°C to +600°C in combination with a Pt100-element according to DIN IEC 751.
- Platinum sensors can be connected directly.
- A line break is indicated to the PLC by the module.
- The conversion can be enabled or disabled for each channel individually.
- Averaging on time or measuring cycles can be parametrized.
- Status indicator LEDs.
- Standard electrical isolation between process and control via optocouplers.
- Ready for use with all CC-Link master modules.

Specifications	AJ65BT-64RD3	AJ65BT-64RD4
Pt100-input points	4	4
Method of measurement	3-wire type	4-wire type
Connectable temperature measuring resistants	Pt100 (conforms to JIS C 1604-1989 and DIN IEC 751), JPt100 (conforms to JIS C 1604-1981)	
Temperature	Measurement range °C	-180 – +600
	Detected value	16 bits signed binary: -1800 – +6000 32 bits signed binary: -180000 – +600000
Overall accuracy	at 25 °C (±5%)	±0.1 % (for the whole measurement range)
	at <20 °C or > 30 °C	±0.25 % (for the whole measurement range)
Resolution	0.025 °C	0.025
Max. conversion time	40 ms / Pt100 input	40 ms / Pt100 input
Isolation	Photocoupler isolation between output terminals and PC power for all modules.	
Modules per network	Max. 16 Pt100 analog input modules in one network	Max. 16 Pt100 analog input modules in one network
I/O points	4 stations (128 devices)	4 stations (128 devices)
Applicable wire size	mm ² 0.75 – 2.0	0.75 – 2.0
External voltage supply	24 V DC	24 V DC
Internal power consumption (24 V DC)	170 mA	170
Weight	kg 0.38	0.38
Dimensions (W x H x D)	mm 152 x 65 x 63	152 x 65 x 63
Order information	Art. no. 88026	88027

■ CC-Link Remote High-Speed Counter Modules

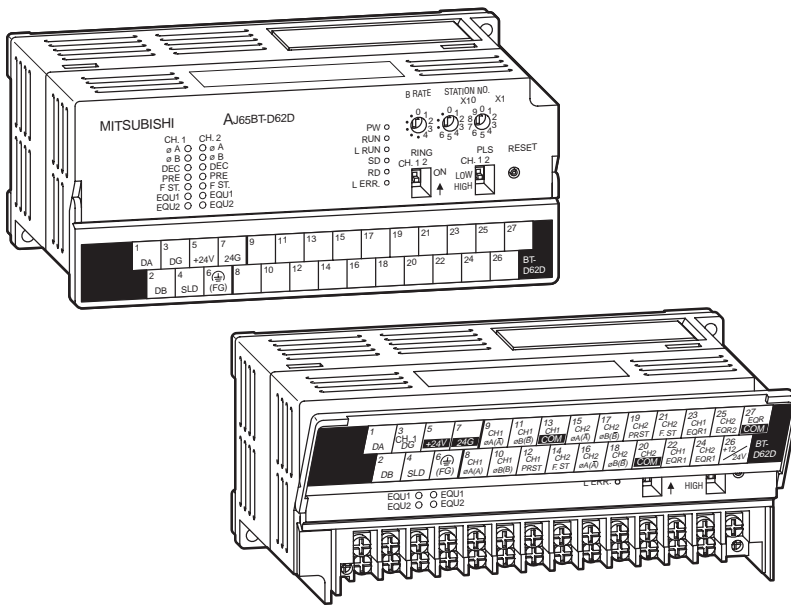

Automatic hardware counter

The high-speed counter modules acquire signals at a frequency which conventional input modules can not acquire. Positioning tasks or frequency measurements for example can be performed.

Special features:

- Input for incremental shaft encoder with automatic forward and reverse detection.
- Count preset via external signals or via the PLC program by the PRESET function.
- Ring counter for counting up to a predefined value with automatic reset to the initial value.
- Functions such as velocity measurement, determining switching points or periodical counting are provided.
- Automatic multiplication of the counted values.
- Status indicator LEDs.
- Ready for use with all CC-Link master modules.



Specifications	AJ65BT-D62	AJ65BT-62D / 62D-S1
Counter inputs	2 (1 or 2 phases)	2 (1 or 2 phases)
Signal levels	5 / 12 / 24 V DC (2 – 5 mA)	EIA Standard, RS-422-A difference driver
Max. counting frequency	pulse/s 200000	400000
Counting range	23 bits + sign (binary), 0 – 16777215	23 bits + sign (binary), 0 – 16777215
Comparison range	24 bits + sign (binary)	24 bits + sign (binary)
Counter type	Both modules are equipped with UP/DOWN preset counter and ring counter function.	
External digital input points	Preset, count disable function	Preset, count disable function
Min. input pulse width	1 / 2 phase: 5 μs 1 phase: 100 μs; 2 phase: 142 μs	1 phase: 2.5 μs; 2 phase: 3.3 μs; 1 phase: 100 μs; 2 phase: 142 μs
External	inputs	5 / 12 / 24 V DC (2 – 5 mA)
	response time	OFF → ON < 0.5 ms ON → OFF < 3 ms
External	outputs	2 A
	response time	< 0.1 ms
I/O points	4 stations (128 devices)	4 stations (128 devices)
Applicable wire size	mm ² 0.75 – 2.0	0.75 – 2.0
Internal power consumption (24 V DC)	mA 70	D62D: 100; D62D-S1: 120
Weight	kg 0.41	0.42
Dimensions (W x H x D)	mm 152 x 65 x 63	152 x 65 x 63
Order information	Art. no. 88028	88029 / 88030

■ CC-Link Remote Input Modul for Temperature Measurement

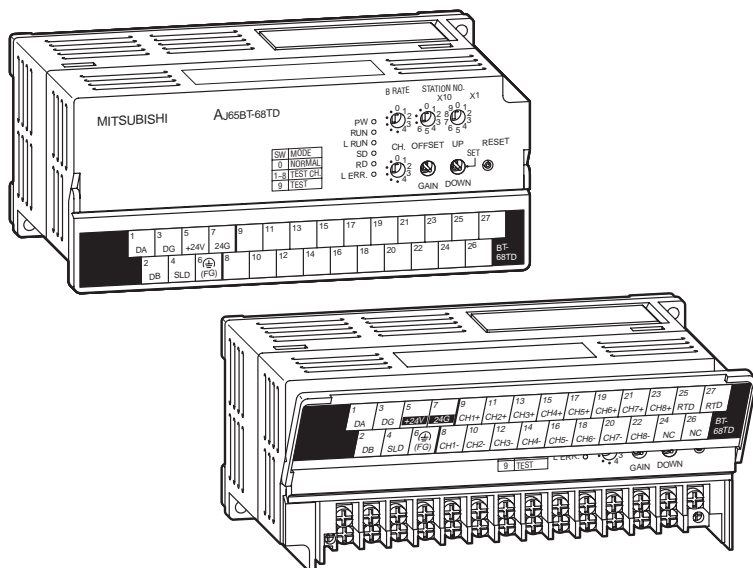

Temperature measuring via thermoelement

This module supports temperature measurements via thermocouples.

Special features:

- The module provides 8 thermoelement inputs that can be addressed independently.
- Linearized measuring range up to 1700 °C (depending on thermoelement).
- Support for thermoelement types B, R, S, K, E, J, T with characteristics of thermoelectric voltages according to DIN IEC 584-1.
- Line break detection for each input channel.
- Cold junction compensation is possible.
- Standard electrical isolation between process and control via optocoupler.

Specifications		AJ65BT-68TD			
Input points		8			
Temperature input range	°C	0 – 1700			
Detected temperature value		16 bits signed binary: 0 – 17000 (value to the first decimal place x 10)			
Scaling value	°C	16 bits signed: 0 – +2000			
Thermocouple	Type	Temperature measurement range	Conversion accuracy (at operating ambient temperature is Ta = 25 ± 5°C)	Temperature characteristic (when operating ambient temperature varies by ΔT = 1 °C)	
	B	600 – 1700 °C	±2.5 °C	±0.4 °C	
	R	200 – 1600 °C	±2 °C	±0.3 °C	
	S	200 – 1600 °C	±2 °C	±0.3 °C	
	K	0 – 1200 °C			
	E	0 – 800 °C	±0.5 °C or 0.25 % of the measured temperature which ever is larger	±0.07 °C or 0.02 % of the measured temperature which ever is larger	
	J	0 – 750 °C			
	T	0 – 350 °C			
Cold junction compensation accuracy		±1 °C			
Overall accuracy		(Conversion accuracy Ta) + (temperature characteristic) x (operating ambient temperature variation) ± 1 °C			
Max. conversion time		45 ms / channel, without respect to the number of used channels			
Absolute max. input voltage	V	±5			
Isolation method		Transformer			
I/O points		4 stations (128 devices)			
Applicable wire size	mm ²	0.75 – 2.0			
Internal power consumption (5 V DC)	mA	81			
Weight	kg	0.40			
Dimensions (W x H x D)	mm	152 x 65 x 63			
Order information	Art. no.	88025			

■ CC-Link Remote Positioning Module

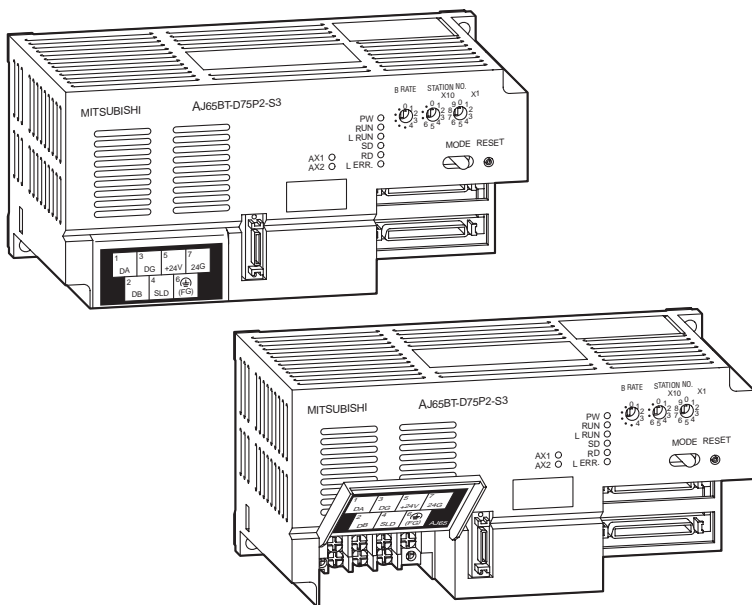

Positioning with an open control loop

The module generates the go command via a pulse chain. The velocity is proportional to the pulse frequency. The travel is proportional to the pulse length.

Special features:

- Control of up to two axes, linear interpolation or circular interpolation.
- Storage of up to 600 items of positioning data.
- Travel unit can be specified pulse, mm, inch or degree.
- In connection with the MELSERVO MR-J2 servo amplifier an absolute position detection system can be configured.
- 7 types of home position return functions are available.
- Parameterization and specification of positioning data can be done entirely by the PLC program or by the MS-DOS Software SW1IVD-AD75PE.

Specifications		AJ65BT-D75P2-S3	
Control axes	2		
Interpolation	Linear interpolation (2 axes), circular interpolation(2 axes)		
Points per axis	600		
Positioning	method	Pulse control "Point to Point" (absolute data and/or incremental); speed/position switching control: (incremental); locus control (absolute data and/or incremental)	
	positioning units	absolute data:	-2147483648 – 2147483647 pulse
			-214748364.8 – 214748364.7 μm
			-21474.83648 – 21474.83647 inch
			0 – 359.99999 degree
	incremental:	-2147483648 – 2147483647 pulse	
		-214748364.8 – 214748364.7 μm	
		-21474.83648 – 21474.83647 degree	
		-21474.83648 – 21474.83647 inch	
	Speed/position switching control:	0 – 2147483647 pulse	
		0 – 214748364.7 μm	
		0 – 21474.83647 degree	
		0 – 21474.83647 inch	
	positioning speed	1 – 1000000 pulse/min	
		0.01 – 6000000.00 mm/min	
		0.001 – 600000.000 degree/min	
		0.001 – 600000.000 inch/min	
	acceleration/ deceleration processing	Automatic trapezoidal or S-pattern acceleration and deceleration	
	acceleration and deceleration time	1 – 65535 ms (4 patterns each can be set)	
Offset	Electronic gear and backlash compensation		
I/O points	4 stations with each 128 devices		
Internal power consumption (5 V DC)	mA	300	
Weight	kg	0.5	
Dimensions (W x H x D)	mm	170 x 63.5 x 80	
Order information	Art. no.	88002	
Accessories	Software for all MELSEC positioning modules: SW1IVD-AD75PE, art. no.: 65619; adapter cable: A1SD75-C01H, art. no.: 54943		



■ CC-Link Remote RS232C Interface Module

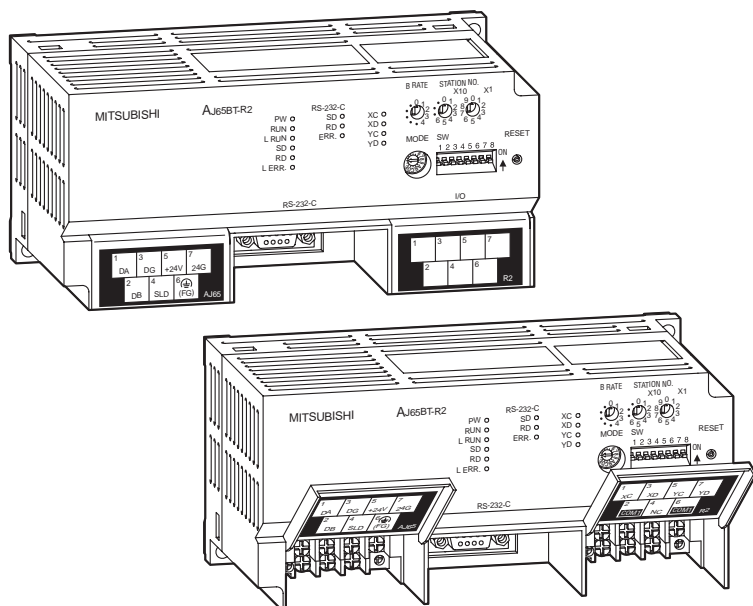

Data exchange with peripherals

This module serves for the communication with peripheral devices through a standard RS232C interface. The peripherals are connected point to point (1:1).

Special features:

- Access capabilities of host PCs with visualization or monitor software to the complete data set of the MELSEC AnAS CPU.
- Supported ASCII data exchange with connected devices such as bar code readers, weighing or identification systems.
- Two universal digital inputs and outputs each.
- Printer control options.
- LED indicators for the module and communications status.

Specifications		AJ65BT-R2
Interface	Typ	RS232C (D-Sub, 9 pole)
Communications mode		Full duplex (without protocol)
Synchronisation		Start/stop synchronisation
Data transfer	speed	bit/s 300, 600, 1200, 2400, 4800, 9600, 19200 (selectable)
	channel	Bus (RS485)
	distance	m 15
Data format		1 start bit, 7 or 8 data bits, 1 or 0 parity bits, 1 or 2 stop bits
Error correction		Parity check, checksum
DTR/DSR control		YES / NO selectable
X ON / X OFF (DC1 / DC3)		YES / NO selectable
Universal I/Os	input data	2 inputs 24 V DC (sink / source type)
	output data	2 Transistor outputs 12/24 V DC
I/O points		1 station (32 addresses)
External power supply	V DC	24
Internal power consumption (5 V DC)	mA	110
Weight	kg	0.4
Dimensions (W x H x D)	mm	170 x 80 x 63,5
Order information	Art. no.	88003

Interface Boards for CC-Link

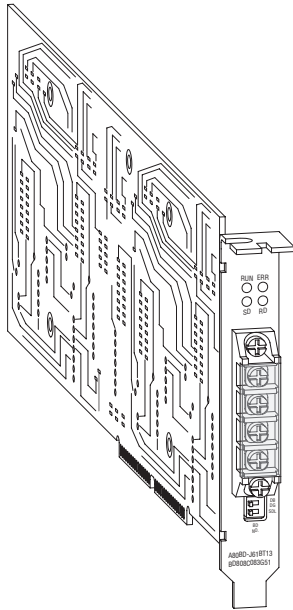

Interface board for CC-Link

The interface board serves for the integration of a personal computer as local station into the CC-Link network.

Special features:

- PCI board for plug-and-play without DIP switch configuration.
- Monitor and test function of data available within the network supported.
- Prepared for user-defined programming.

Specifications		A80BD(E)-J61BT13
Module type		Slave
Transmission speed	Mbit/s	0.156; 0.625; 2.5; 5; 10 (selectable)
Max. transmission distance		Dependent on the transmission speed (see master module)
Link devices	per system	2048 link relays, 256 registers
	per station	30 link relays, 256 registers
Communications method		Polling
Synchronisation method		Frame synchronisation method
Modulation		NRZI
Transmission method		Bus (RS485)
Transmission format		HDLC
Boards per network		Max. 4
System requirements (PC)		Windows NT Workstation 4.0 or higher, with Pentium processor ≥ 133 MHz, 1 free PCI slot, min. 32 MB RAM, min. 20 MB ROM (harddisk)
Internal power consumption (5 V DC)	mA	400
Weight	kg	0.16
Dimensions (W x H x D)	mm	192 x 107 x 8.8
Order information	Art. no.	102866



MELSEC I/O Link Network

Communications Modules

MELSEC I/O Link enables you to operate up to 64 remote inputs and 64 remote outputs.

All I/Os in the network are automatically and cyclically updated at 5.4 μ s intervals.

Up to 16 I/O modules can be connected to a master unit.

Structure

The data line's tree topology enables you to install T-junctions at any point, similar to a normal house service installation. You only need to ensure that the total coverage of the network does not exceed 200 m.

Cable type

The network uses ordinary shielded twisted-pair cabling as the communications medium.

Administration

For the control program there is no difference at all between the remote I/Os and the local I/Os on the PLC's base units.

The station numbers of the remote I/O modules are set with simple rotary switches, making installation very easy. You also need to set the master station DIP switches for the assigned station numbers to ON.

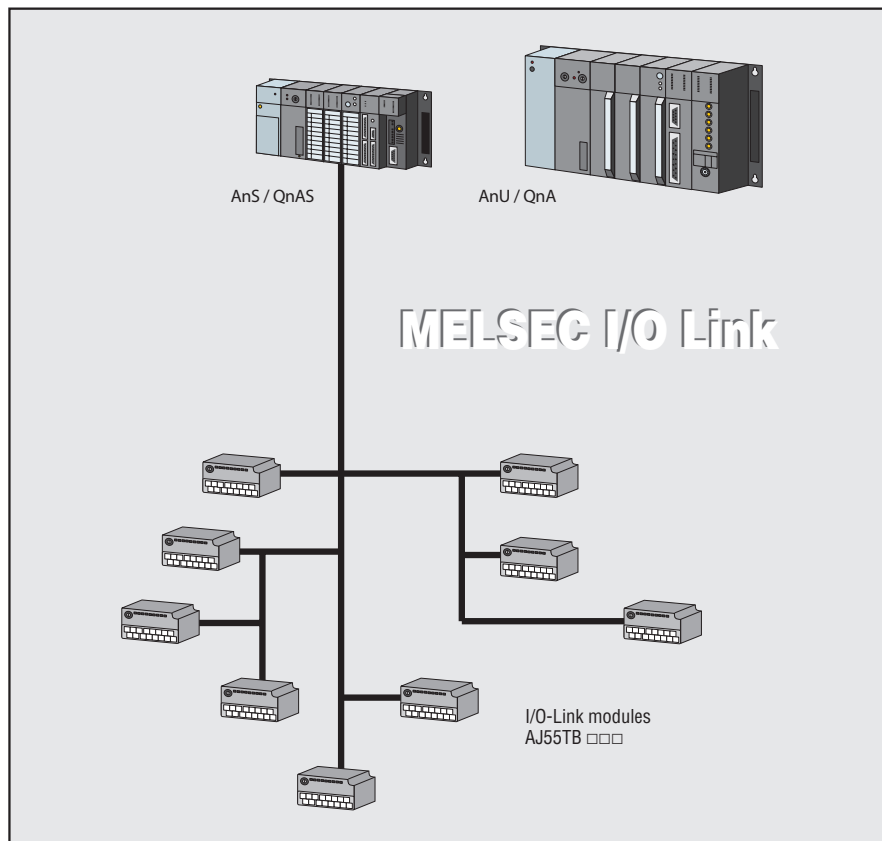

Interface	Shielded twisted-pair cabling
Cross-section	0.75 mm ² (1 pair)
Loop resistance	≤ 29 Ω / km
Electrostatic capacity	75 nF / km
Impedance (100 kHz)	110 Ω ± 10 %
Insulation resistance	≥ 500 M Ω / km
Maximum distance	200 m

Important: Do not exceed the specified electrostatic capacity!

MELSEC I/O Link Master Module

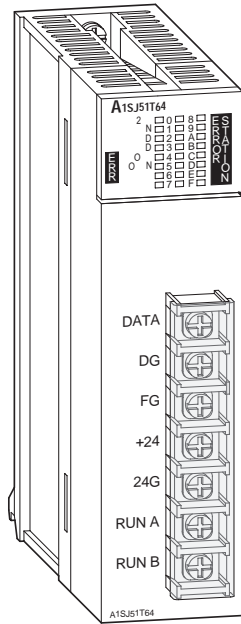

Local I/Os with flexible installation

The MELSEC I/O Link is very simple to handle. To put it into operation, all that is necessary is to set DIP switches to indicate which stations are present. Otherwise, the local I/Os behave in the same way as locally installed ones and are programmed in the same way via the PLC program.

Special features:

- Online diagnostics by means of LEDs
- Cabling in tree structure (T connections possible)
- Up to 128 inputs/outputs per module
- Refresh time of 5.4 ms for 64 I/Os
- The number of master modules is limited only by the address range of the CPU.
- Transmission distance up to 200 m (cable length)
- Indication of faulty stations by means of LEDs

Specifications		A1SJS1T64
Controllable I/O points		128 (using mixed modules with 4 inputs / 4 outputs)
I/O refresh time		ms ca. 5.4
Communi- cation	rate	bit/s 38400
	method	Register insertion method
	synchronization method	Combination of frame-synchronization and bit-synchronization
	error control system	Parity check
	transmission path	Bus / tree system
	transmission total distance	m 200
	I/O stations	16 (modules with 4 I/Os)
Communi- cation cable	type	Shielded twisted pair cable
	no. of cores	2
	diameter	≥ 0.5 mm ²
Error (RUN) display of stations		LED
No. of occupied I/O points		64 (definable by I/O assignment)
Applicable wire size		mm ² ≥ 0.75
External	voltage supply	21.6 – 27.6 V DC
	current supply (24 V DC)	mA 90
Internal power consumption (5 V DC)		mA 115
Weight		kg 0.3
Dimensions (W x H x D)		mm 34.5 x 130 x 93.6
Order information		Art. no. 47192
Accessories		I/O link modules AJ55TB □□□ (refer to the following page)



MELSEC I/O Link Modules for A1S/J51T64

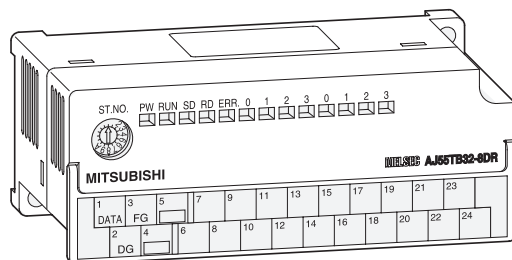
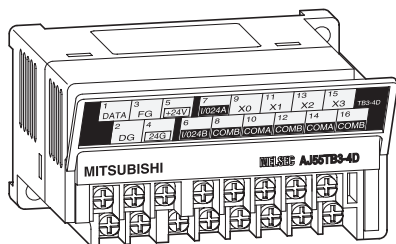

Local I/Os in compact design

The local I/Os have little granularity. For example, mixed modules with 2 input points and 2 output points are available.

This system is perfect for updating existing machinery.

Special features:

- Very compact design
- Three-conductor connection technology for input points
- Installation by screws or integrated DIN rail adapter
- Modules with 4, 8 and 16 input/output points
- Galvanic isolation between process and controller by photocoupler is a standard feature.
- Indication of the status of the input/output points by LEDs
- Adjustment of station numbers via rotaryswitch

Specifications		AJ55TB3-4D	AJ55TB3-8D	AJ55TB3-16D	AJ55TB32-4DR	AJ55TB32-8DR	AJ55TB32-16DR
Controllable I/O points		4	8	16	2 + 2	4 + 4	8 + 8
Operating voltage range	V DC	19.2 – 26.4	19.2 – 26.4	19.2 – 26.4	21.6 – 26.4	21.6 – 26.4	21.6 – 26.4
Rated input voltage		24 V DC (7 mA)	24 V DC (7 mA)	24 V DC (7 mA)	24 V DC (7 mA)	24 V DC (7 mA)	24 V DC (7 mA)
Rated output voltage		—	—	—	24 V DC (2 A/point) 240 V AC (4 A/common)	24 V DC (2 A/point) 240 V AC (4 A/common)	24 V DC (2 A/point) ①
Switch ON	voltage	V ≥ 14	≥ 14	≥ 14	≥ 14	≥ 14	≥ 14
	current	mA ≥ 3.5	≥ 3.5	≥ 3.5	≥ 3.5	≥ 3.5	≥ 3.5
Switch OFF	voltage	V ≤ 6	≤ 6	≤ 6	≤ 6	≤ 6	≤ 6
	current	mA ≤ 1.7	≤ 1.7	≤ 1.7	≤ 1.7	≤ 1.7	≤ 1.7
Load resistance	kΩ	3.3	3.3	3.3	3.3	3.3	3.3
Min. switching load		—	—	—	5 V DC (1 mA)	5 V DC (1 mA)	5 V DC (1 mA)
Max. switching voltage	V	—	—	—	250 V AC / 110 V DC	250 V AC / 110 V DC	49.9 V AC
Response time	OFF → ON	ms ≤ 10	≤ 10	≤ 10	In: ≤ 10 / Out: ≤ 10	In: ≤ 10 / Out: ≤ 10	In: ≤ 10 / Out: ≤ 10
	ON → OFF	ms ≤ 10	≤ 10	≤ 10	In: ≤ 10 / Out: ≤ 12	In: ≤ 10 / Out: ≤ 12	In: ≤ 10 / Out: ≤ 12
Life	mechanical	—	—	—	20 Mio. cycles	20 Mio. cycles	20 Mio. cycles
	electrical	—	—	—	100000 cycles	100000 cycles	100000 cycles
Max. switching frequency		—	—	—	3600 cycles/h	3600 cycles/h	3600 cycles/h
Max. inputs ON simultaneously		100 %	100 %	100 %	100 %	100 %	100 %
Input/output indicator		All modules provide a red LED for each input/output.					
Isolation method		All modules fitted with photocoupler isolation between input terminals and internal circuit.					
Communication cable		Shielded twisted pair 0.75 mm ² x 1P / lead cable 0.75 mm ² x 2C (for further information contact the Mitsubishi Electric service)					
I/O unit power supply	voltage	V DC 15.6 – 27.6	15.6 – 27.6	15.6 – 27.6	15.6 – 27.6	15.6 – 27.6	15.6 – 27.6
	current	mA 35	45	60	40	50	70
External voltage supply		—	—	—	24 V DC / 240 V AC	24 V DC / 240 V AC	24 V DC
External power consumption (24 V DC)	mA	—	—	—	12	23	45
Weight	kg	0.2	0.3	0.4	0.2	0.3	0.4
Dimensions (W x H x D)	mm	82 x 45 x 66	114 x 45 x 66	177 x 45 x 66	82 x 45 x 66	114 x 45 x 66	177 x 45 x 66

Ordering information	Art. no.	47191	47190	58548	47186	47185	58546
----------------------	----------	-------	-------	-------	-------	-------	-------

Accessories		—					
-------------	--	---	--	--	--	--	--

① In case of 240 V AC the unit does not comply to CE-standard.

■ MELSEC I/O Link Modules for A1SJ51T64

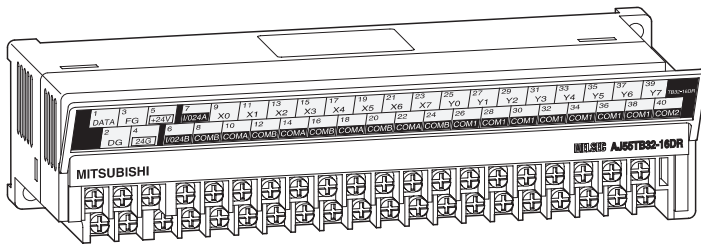
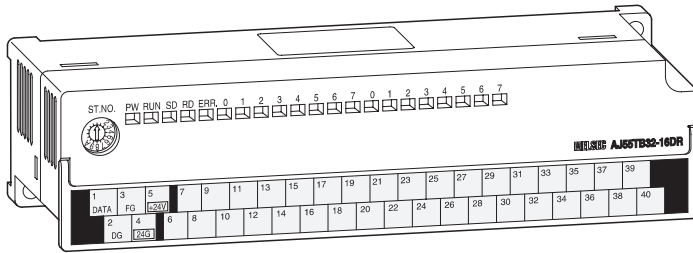

Specifications	AJ55TB2-4R	AJ55TB2-8R	AJ55TB2-16R
Controllable I/O points	4	8	16
Operating voltage range	V DC	—	—
Rated input voltage	—	—	—
Rated output voltage	24 V DC (2 A/point) 240 V AC (8 A/common)	24 V DC (2 A/point) 240 V AC (8 A/common)	24 V DC (2 A/point, 8 A/common) ①
Switch ON	voltage V current mA	—	—
Switch OFF	voltage V current mA	—	—
Load resistance	kΩ	—	—
Min. switching load	5 V DC (1 mA)	5 V DC (1 mA)	5 V DC (1 mA)
Max. switching voltage	250 V AC / 110 V DC	250 V AC / 110 V DC	49.9 V AC
Response time	OFF → ON ms ON → OFF ms	≤ 10 ≤ 12	≤ 10 ≤ 12
Life	mechanical electrical	20 Mio. cycles 100000 cycles	20 Mio. cycles 100000 cycles
Max. switching frequency	3600 cycles/h	3600 cycles/h	3600 cycles/h
Max. inputs ON simultaneously	—	—	—
Input/output indicator	All modules provide a red LED for each input/output.		
Isolation method	All modules fitted with photocoupler isolation between input terminals and internal circuit.		
Communication cable	Shielded twisted pair 0.75 mm ² x 1P / lead cable 0.75 mm ² x 2C (for further information contact the Mitsubishi Electric service)		
I/O unit power supply	voltage current mA	15.6 – 27.6 V DC 50	15.6 – 27.6 V DC 85
External voltage supply	24 V DC / 240 V AC	24 V DC / 240 V AC	24 V DC
External power consumption (24 V DC)	mA	23	90
Weight	kg	0.2	0.4
Dimensions (W x H x D)	mm	82 x 45 x 66	177 x 45 x 66
Ordering information	Art. no.	47189	47187
Accessories	—		

① In case of 240 V AC the unit does not comply to CE-standard.



The PROFIBUS/DP Network

Data Communications

The open PROFIBUS/DP network enables extremely fast data exchange with a very wide variety of slave devices, including:

- Remote digital I/Os
- Remote analog I/Os
- Remote intelligence PLC (FX0N, FX2N)
- Frequency inverters (FR-A 240, FR-A 540 (L), FR-E 500)
- Operator terminals (MAC E series)
- A range of other devices from third-party manufacturers

Structure

The maximum coverage of a bus segment is 1200 m (at a maximum of 93.75 kbit/s). Up to 3 repeaters are allowed. Thus the maximum distance between 2 stations is calculated with 4800 m.

Cable types

To help reduce costs PROFIBUS/DP uses RS 485 technology with simple twisted-pair cabling.

Suitable cables include the UNITRONIC BUSLD from Lappkabel and the DUE 4451 from Alcatel.

Data exchange

The PROFIBUS AJ71PB92D and A1SJ71PB92D master modules support slave device data exchange with up to 244 send bytes and 244 receive bytes. This means you can exchange a total of up to 128 bytes with a slave unit per network cycle.

Administration

In combination with the MELSEC ProfiMap configuration software the AJ71PB92D PROFIBUS/DP master unit gives you user-friendly plug-and-play technology. The configuration software is self-explanatory, using a graphical model for setting up the network. You simply select the slave unit (e.g. FX2N), assign the station numbers and specify where the information is stored in the master CPU.

Of course, PROFIBUS/DP slaves from MITSUBISHI ELECTRIC can also be connected to master devices from other manufacturers.

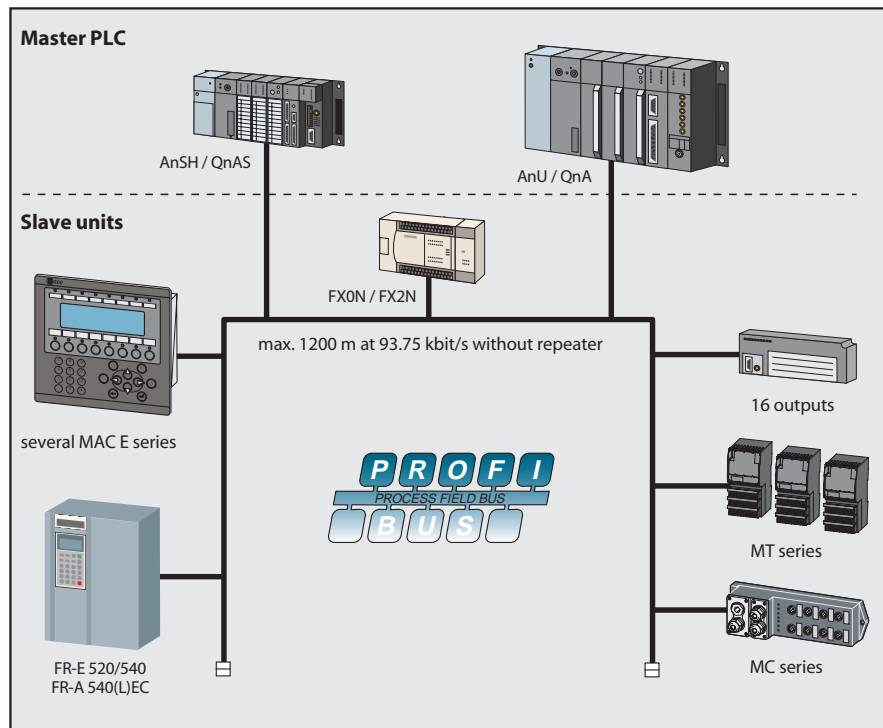

Specifications	Master AJ71PB92	Master A1SJ71PB92D
Communications protocol	EN 50170 / DIN 19245-T3	
Cabling	Shielded twisted-pair with 24 AWG = 0.22 mm ² , impedance: 100 – 130 Ω; Shielded twisted-pair with 22 AWG = 0.34 mm ² , impedance: 135 – 165 Ω;	
Interface	RS485	
Data transfer rate	distance	
	1 200 m	kbit/s 9.6 / 19.2 / 93.75
	1 000 m	kbit/s 187.5
	400 m	kbit/s 500
Max total distance	200 m	kbit/s 1 500
	m	4800 (3 repeaters)
Slave units per master	60	
Stations per segment	32	
Repeaters per network	3	
Accessories	ProfiConT: PROFIBUS 9-pin D-SUB plug connector for up to 12 Mbaud, art. no. 87035 (refer to page 82)	

PROFIBUS DP/FMS Module

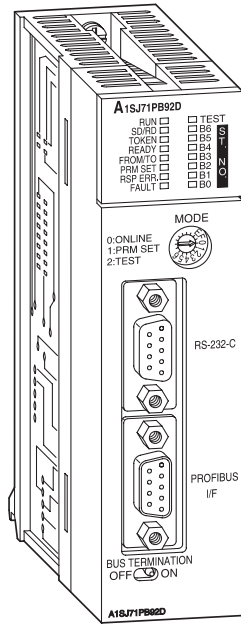

The open standard for MELSEC PLCs

The A1SJ71PB96F PROFIBUS/FMS module and the A1SJ71PB92D PROFIBUS/DP module enable MELSEC programmable logic controllers to communicate with other PROFIBUS devices.

Special features:

- The A1SJ71PB92D PROFIBUS/DP master can communicate with up to 60 slave units. Up to 32 input bytes and 32 output bytes can be processed at a time per slave station. Supported functions include Sync, Freeze and specialised diagnostics messages for the specific slave types used.
- The A1SJ71PB96F PROFIBUS/FMS master supports up to 32 links and supports simple variables, records and arrays.



Specifications	A1SJ71PB96F	A1SJ71PB92D	
Module type	Master	Master	
Protocol	EN50170, DIN19245T1+2	EN50170, DIN19245T3	
Interface type	RS485	RS485	
Communications mode	Logical token ring with subordinate Master/Slave procedure	Logical token ring with subordinate Master/Slave procedure	
Topology	Bus	Bus	
Modulation	NRZ	NRZ	
Cabling	Shielded twisted-pair	Shielded twisted-pair	
Communications distance	9.6 kbps 19.2 kbps 93.75 kbps	m 1200	1200, 4800 (3 repeaters)
	187 kbps	m 600	1000, 4000 (3 repeaters)
	500 kbps	m 200	400, 1600 (3 repeaters)
	1500 kbps	m 100	200, 800 (3 repeaters)
	3 Mbps 6 Mbps 12 Mbps	m —	100, 400 (3 repeaters)
Max. nodes	32, 62 (1 repeater), 92 (2 repeaters), 122 (3 repeaters)	32, 62 (1 repeater), 92 (2 repeaters), 126 (3 repeaters)	
Repeaters per network	Max. 3	Max. 3	
I/O points	32	32	
Internal power consumption (5 V DC)	mA 560	560	
Weight	kg 0.27	0.27	
Dimensions (W x H x D)	mm 34.5 x 130 x 93.6	34.5 x 130 x 93.6	
Order information	Art. no. 46421	63393	
Accessories	Configuration software incl. configuration cable for A1SJ71PB92D, A1SJ71PB96F: MELSEC ProfiMap, art. no.: 102996 PROFIBUS plug connector for up to 12 Mbaud: ProfiConT, art. no 87035 (refer to page 82)		

■ PROFIBUS/DP Compact I/O Modules

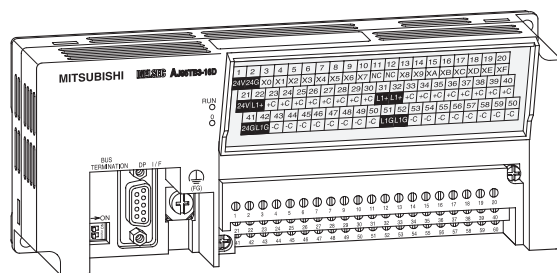
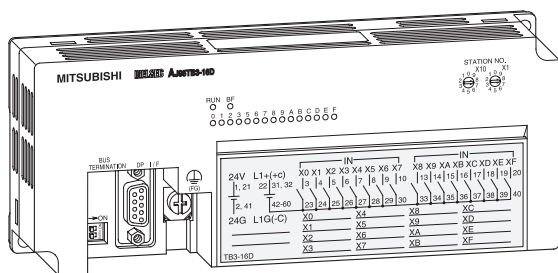

Compact I/O modules for PROFIBUS/DP

These PROFIBUS/DP I/O modules enable signal registration at the machine with relatively short cables. The reduced cabling requirements and the ability to activate individual machine components automatically are among the great advantages of these modules.

Special features:

- I/Os and PROFIBUS/DP cable electrically isolated from the internal circuitry
- Outputs protected with melt fuse
- Support for data transfer rates from 9 600 baud to 12 Mbaud
- 3-pole sensor connection technology
- Removable terminal block with screw terminals
- Integrated switchable terminating resistors
- Rotary switch station number allocation
- Both DIN rail and screw mounting supported

Specifications	AJ95TB3-16D	AJ95TB2-16T	AJ95TB32-16DT
Controllable I/O points	16 Input points	16 Transistor outputs	8 Input points / 8 transistor outputs
I/Os in groups with	16	8	8
Occupied stations	1	1	1
Input data			
Operating voltage range	V DC 19.2 – 26.4	—	19.6 – 26.4
Rated input voltage	24 V DC (7 mA)	—	24 V DC (7 mA)
Switch ON	voltage	V ≥ 14	≥ 14
	current	mA ≥ 3.5	≥ 3.5
Switch OFF	voltage	V ≤ 6	≤ 6
	current	mA ≤ 1.7	≤ 1.7
Input resistance	k Ω 3.3	—	3.3
Input type	Sink/source	Source output	Sink/source input, source output
Output data			
Output voltage	—	12/24 V DC (0.8 A/channel) (3.2 A/total)	—
Max. output load	—	0.8 A / output	0.8 A / output
Response time	OFF \rightarrow ON	ms ≤ 10 (input)	≤ 10 (input), ≤ 2 (output)
	ON \rightarrow OFF	ms ≤ 10 (input)	≤ 10 (input), ≤ 2 (output)
External voltage supply	—	10.8 – 26.4 V DC	10.8 – 26.4 V DC
External power consumption (24 V DC)	mA —	35, all I/Os ON, no load	18, all I/Os ON, no load
Withstand strength	V AC 500	500	500
Isolation resistance	≥ 10 M Ω	≥ 10 M Ω	≥ 10 M Ω
Common data			
Isolation	All modules fitted with photocoupler isolation between I/Os.		
Power consumption	voltage	V DC 15.6 – 31.2	15.6 – 31.2
	current	mA 174 (24 V DC)	188 (24 V DC)
Applicable wire size	mm ² 0.18 – 2	0.18 – 2	0.18 – 2
Weight	kg 0.45	0.45	0.45
Dimensions (W x H x D)	mm 197.4 x 80 x 46.5	197.4 x 80 x 46.5	197.4 x 80 x 46.5
Order information	Art. no. 63079	63080	63081
Accessories	PROFIBUS plug connector for up to 12 Mbaud: ProfiConT; art. no 87035 (refer to page 82)		

PROFIBUS/DP MT Modules

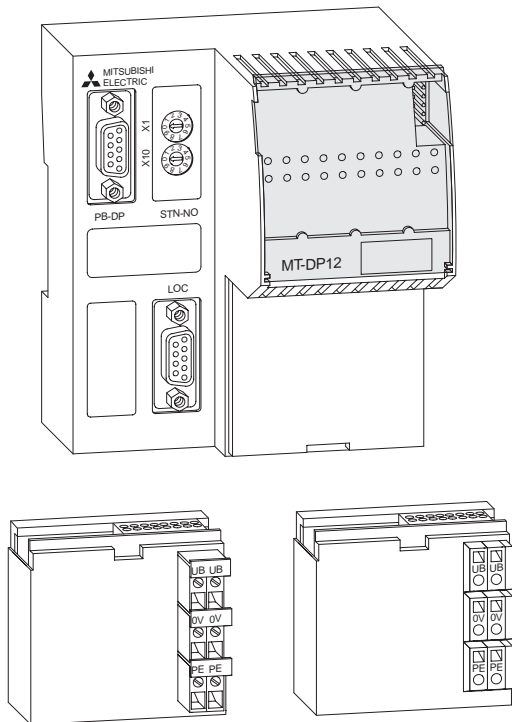

Basic module (head station) of the MT series

The basic module connects the extension modules of the MT series (MT = Modular Type) to the PROFIBUS/DP. The MT devices are mounted to a DIN rail. Due to the additional second interface on the basic module the extension modules can be installed in two rows.

The modules on the separate DIN rail are supplied with data and the system voltage via an extension cable and the local system extension module.

Special features:

- Up to 16 digital and 8 analog extension modules can be connected.
- Automatic detection of the data transfer rate
- Optocouplers between interface and system
- Two selectable types of connecting terminals: screw type and cache clamp terminals
- Supported installation in two rows through the local extension MT-LE-SET to be connected to the basic module.
- Up to 256 digital inputs/outputs per basic module



Specifications	MT-DP12	MT-DP12E
Module type	Basic module of the MT series, PROFIBUS/DP slave	Basic module of the MT series, PROFIBUS/DP slave
Communications	protocol	DIN 19245-T3
	medium	Shielded twisted-pair with 24AWG = 0.22 mm ² , impedance: 100 – 130 Ω; Shielded twisted-pair with 22AWG = 0.34 mm ² , impedance: 135 – 165 Ω
Interface	RS485	RS485
Operation modes	Sync mode and freeze mode are supported	Sync mode and freeze mode are supported
Communications rate	9.6; 19.2; 93.75; 187.5; 500 kBit/S, 1.5; 3; 6; 12 Mbit/s	9.6; 19.2; 93.75; 187.5; 500 kBit/S, 1.5; 3; 6; 12 Mbit/s
Max. total distance	m 4800 (3 repeater)	4800 (3 repeater)
No. of connectable extension modules	Max. 16 extension modules (digital and analog I/O modules)	Max. 4 extension modules (digital and analog I/O modules)
Addressable digital I/Os	256	72
I/O points	—	—
Integrated inputs		
Digital inputs	—	8
Isolation	—	Optocoupler isolation between input terminals and internal power.
Rated input current	—	24 V DC (18 – 30 V)
Response time	OFF → ON ms	1
	ON → OFF ms	1
Short circuit protection	—	Electronic
Status display for inputs	—	The module possesses of status LEDs for all inputs.
Common data		
Applicable wire size	mm ² 0.75 – 2.5	0.75 – 2.5
Power supply	V DC 24	24
Internal power consumption (24 V DC)	A Max. 0.5 (with maximum configuration)	Max. 0.5 (with maximum configuration)
Weight	kg 0.28	0.35
Dimensions (W x H x D)	mm 96 x 114 x 60	96 x 114 x 60
Order information	Art.-Nr. 68887	124622
Accessories	Local system adapter MT-LE with extension cable MT-LE-CBL50 (length 0,5 m) = MT-LE-SET, art. no. 69759 Screw type terminal block MT-DP12-TBS, art. no. 68888 Cache clamp terminal block MT-DP12-TBC, art. no. 68889 PROFIBUS connector for up to 12 Mbaud: ProfiConT, art. no. 87035 (see page 82)	Screw type terminal block MT-DP12E-TBS, art. no.: 124624 Cache clamp terminal block MT-DP12E-TBC, art. no.: 124623 ROFIBUS connector for up to 12 Mbaud: ProfiConT, art. no. 87035 (see page 82)

PROFIBUS/DP MT Modules

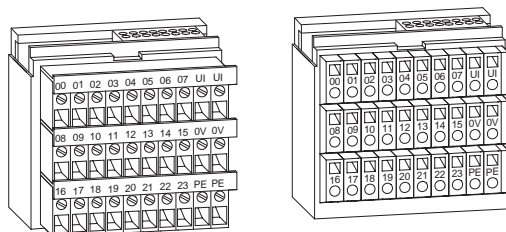
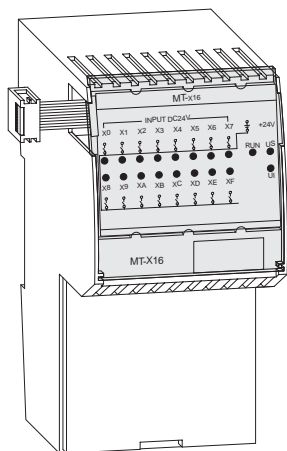

Digital input/mixed modules

The digital input modules of the MT series facilitate the evaluation of process data (contacts, limit switches, etc.) via a PROFIBUS/DP master. Modules with 4, 8 and 16 inputs are supplied.

Beside the 4 inputs the mixed module MT-X4Y4T consists of 4 transistor outputs.

Special features:

- For the 16-type modules potential terminal blocks in three-wire technique are available.
- The driving power supplying the sensors and actors (except relay output) is directly fed into the module.
- Connection of the sensory circuits in three-wire technique
- Standard potential isolation between process and module
- Two selectable types of connecting terminals: screw type and cache clamp terminals

Specifications	MT-X8	MT-X16	MT-X4Y4T
Inputs	8	16	4
Simultaneously ON inputs	70 %	70 %	100 %
Outputs	—	—	4
Output type	—	—	Transistor
Common terminal arrangement	—	—	4
Isolation	Optocoupler isolation between input terminals and internal power for all modules.		
Input voltage (sensor supply)	24 V DC (±25 %)	24 V DC (±25 %)	24 V DC (±25 %)
Output voltage range	—	—	24 V DC (-1 %)
Output voltage (actor supply)	—	—	24 V DC (±25 %)
Max. switching voltage	—	—	—
Rated input current	A 0.7	0.7	0.7
Max. current	per output	A —	0.5
	per group	A —	4
Inrush current	—	—	—
Leakage current at OFF	—	—	< 50 μA
Response time	OFF → ON	ms ≤ 1	≤ 14
	ON → OFF	ms ≤ 1	≤ 0.05
Short circuit protection	Electronic	Electronic	Electronic
Status display for inputs	All modules have one or two status LEDs per input.		
Error indicator	LED	LED	LED
I/O points	8	16	8
Connection terminal	All modules can be fitted with screw type or cache clamp terminal blocks (see accessories).		
Applicable wire size	mm ² 0.75 – 2.5	0.75 – 2.5	0.75 – 2.5
External sensor/actor supply	24 V DC (≤30 mA)	24 V DC (≤30 mA)	24 V DC (≤20 mA)
Internal power consumption (8 V DC)	mA 25	30	35
Weight (without terminal block)	kg 0.16	0.17	0.22
Dimensions (W x H x D)	mm 56 x 114 x 60	56 x 114 x 60	56 x 114 x 60
Order information	Art. no. 68893	68896	124625
Accessories*	Terminal blocks MT-X8-TBS, no. 68894 MT-X8-TBC, no. 68895	MT-X16-TBS, no. 68897 MT-X16-TBC, no. 68898 MT-X16-PTBS, no. 69400 MT-X16-PTBC, no. 69397	MT-X4Y4T-TBS, no. 124626 MT-X4Y4T-TBC, no. 124627

* Description of the terminal blocks: TBS=screw type terminal block, TBC=cache clamp terminal block, PTBS=screw type terminals with potential terminal, PTBC=cache clamp terminals with potential terminal

PROFIBUS/DP MT Modules

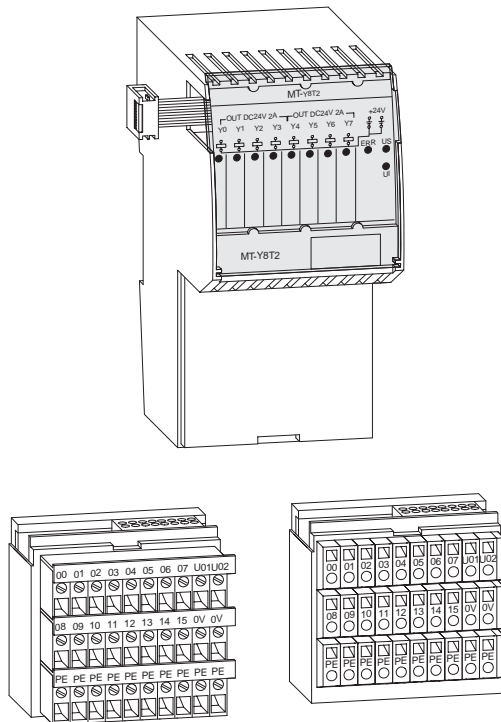

Digital output modules

The digital output modules of the MT series facilitate the evaluation of process data (contacts, limit switches, etc.) via a PROFIBUS/DP master. Modules with 4, 8 and 16 inputs are supplied.

The digital output modules supply different function elements for the customisation to the required control functions.

Special features:

- For the 16-type modules potential terminal blocks in three-wire technique are available.
- The output modules provide transistor outputs rated at 0.5 A and 2 A, and relay outputs with up to 3 A (AC).
- The driving power supplying the sensors and actors (except relay output) is directly fed into the module.
- Connection of the sensory circuits in three-wire technique
- Standard potential isolation between process and module
- Two selectable types of connecting terminals: screw type and cache clamp terminals

Specifications	MT-Y8T	MT-Y16T	MT-Y8T2	MT-Y4R	MT-Y8R5	
Outputs	8	16	8	4	8	
Output type	Transistor	Transistor	Transistor	Relay	Relay	
Common terminal arrangement	8	8	4	1	1	
Isolation	Optocoupler isolation between input and output terminals and internal power for all modules.					
Output voltage range	24 V DC (-1 %)	24 V DC (-1 %)	24 V DC (-0.5 %)	24 / 110 / 230 V DC, AC	24 / 110 / 230 V DC, AC	
Output voltage (actor supply)	24 V DC (±25 %)	24 V DC (±25 %)	24 V DC (±25 %)			
Max. switching voltage	—	—	—	250 V AC	250 V AC	
Switching capacity conf. EN60947/5/1	at 24 V	—	—	2 A (AC15) / 1.3 A (DC 13)	5 A (AC12) / 3 A (AC15) / 1.0 A (DC 13)	
	at 110 V	—	—	2 A (AC15) / 0.25 A (DC 13)	5 A (AC12) / 3 A (AC15) / 0.2 A (DC 13)	
	at 220 V	—	—	2 A (AC15) / 0.1 A (DC 13)	5 A (AC12) / 3 A (AC15) / 0.1 A (DC 13)	
Max. current	per output	A 0,5	0,5	2	—	
	per group	A 4	4	4	—	
Leakage current at OFF	<50 µA	<50 µA	6 µA	—	—	
Response time	OFF → ON	ms ≤ 0.14	≤ 0.14	≤ 0.3	10 ms	
	ON → OFF	ms ≤ 0.05	≤ 0.05	≤ 0.08	5 ms	
Short circuit protection	Electronic	Electronic	Electronic	—	—	
Status display for outputs	All modules have one or two status LEDs per output.					
Error indicator	LED	LED	—	—	—	
I/O points	8	16	8	8	8	
Connection terminal	All modules can be fitted with screw type or cache clamp terminal blocks (see accessories).					
Applicable wire size	mm ² 0.75 – 2.5	0.75 – 2.5	0.75 – 2.5	0.75 – 2.5	0.75 – 2.5	
External sensor/actor supply	24 V DC (≤20 mA)	24 V DC (≤20 mA)	24 V DC (≤20 mA)	24 V DC (≤20 mA)	24 V DC (≤20 mA)	
Internal power consumption (8 V DC)	mA 35	60	35	Max. 45	Max. 120	
Weight (without terminal block)	kg 0.16	0.16	0.18	0.175	0.325	
Dimensions (W x H x D)	mm 56 x 114 x 60	56 x 114 x 60	56 x 114 x 60	56 x 114 x 60	112 x 114 x 60	
Order information	Art. no. 68899	68902	68905	68908	124628	
Accessories*	Terminal blocks	MT-Y8T-TBS, no. 68900	MT-Y16T-TBS, no. 68903	MT-Y8T2-TBS, no. 68906	MT-Y4R-TBS, no. 69401	MT-Y8R5-TBSLR, no. 125534
		MT-Y8T-TBC, no. 68901	MT-Y16T-TBC, no. 68904	MT-Y8T2-TBC, no. 68907	MT-Y4R-TBC, no. 69402	MT-Y8R5-TBCLR, no. 125533

* Description of the terminal blocks: TBS=screw type terminal block, TBC=cache clamp terminal block, PTBS=screw type terminals with potential terminal, PTBC=cache clamp terminals with potential terminal

PROFIBUS/DP MT Modules

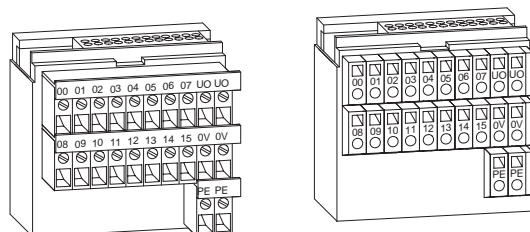
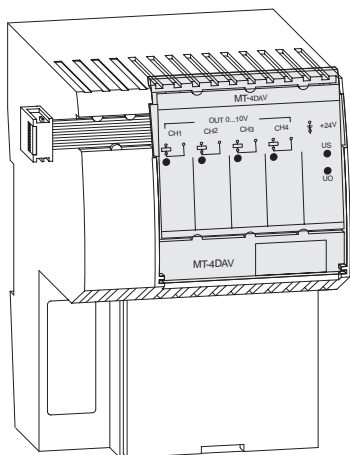

Analog input/output modules

Analog input modules of the MT series convert analog process data like pressure, temperature, etc. into digital values that are sent to the PROFIBUS/DP master.

The analog output modules convert the digital values sent from the PROFIBUS/DP master into an analog voltage signal. This signal can be used to control valves, inverters, servomotors, etc.

Special features:

- 4 separately parameterisable channels per module
- Voltage, current, and temperature evaluation (MT-4AD) can be set via parameter.
- The driving power supplying the sensors and actors is directly fed into the module.
- With the analog input module current, voltage, and 4-wire PT100 inputs can be operated in parallel
- Two selectable types of connecting terminals: screw type and cache clamp terminals
- Standard potential isolation between process and module

Specifications	MT-4AD	MT-4DA	MT-4DAV																				
Module type	Analog input module	Analog output module	Analog output module																				
No. of channels	4	4	4																				
Analog input	-10 V – +10 V, -20 mA – +20 mA, 4 – 20 mA, -180 – +600 °C (PT100)	—	—																				
Resolution of digital output	16 bits binary (incl. sign)	—	—																				
Resolution of digital input	—	16 bits binary (incl. sign)	16 bits binary (incl. sign)																				
Analog output	—	-10 – +10 V, 0 – +20 mA	0 – 10 V DC																				
Input resistance	voltage kΩ 176 current Ω 50	—	—																				
Max. input	voltage V ±15 current mA ±30	—	—																				
Max. output load	—	≥750 Ω	≥750 Ω																				
I/O characteristics	<table border="1"> <thead> <tr> <th>Analog input</th> <th>Digital output</th> </tr> </thead> <tbody> <tr> <td>-10 – +10 V</td> <td>-4000 – +4000</td> </tr> <tr> <td>-20 – +20 mA</td> <td>-4000 – +4000</td> </tr> <tr> <td>4 – 20 mA</td> <td>0 – +4000</td> </tr> <tr> <td>-180 – +600 °C</td> <td>-1800 – +6000</td> </tr> </tbody> </table>	Analog input	Digital output	-10 – +10 V	-4000 – +4000	-20 – +20 mA	-4000 – +4000	4 – 20 mA	0 – +4000	-180 – +600 °C	-1800 – +6000	<table border="1"> <thead> <tr> <th>Digital input</th> <th>Analog output</th> </tr> </thead> <tbody> <tr> <td>-2000 – +2000</td> <td>-10 – +10 V</td> </tr> <tr> <td>0 – 2000</td> <td>0 – +20 mA</td> </tr> </tbody> </table>	Digital input	Analog output	-2000 – +2000	-10 – +10 V	0 – 2000	0 – +20 mA	<table border="1"> <thead> <tr> <th>Digital input</th> <th>Analog output</th> </tr> </thead> <tbody> <tr> <td>0 – 4000</td> <td>0 – 10 V</td> </tr> </tbody> </table>	Digital input	Analog output	0 – 4000	0 – 10 V
Analog input	Digital output																						
-10 – +10 V	-4000 – +4000																						
-20 – +20 mA	-4000 – +4000																						
4 – 20 mA	0 – +4000																						
-180 – +600 °C	-1800 – +6000																						
Digital input	Analog output																						
-2000 – +2000	-10 – +10 V																						
0 – 2000	0 – +20 mA																						
Digital input	Analog output																						
0 – 4000	0 – 10 V																						
Max. resolution	2.5 mV 5 μA 4 μA 0.125 °C	5 μV 10 μA	— 2.5 mV																				
Overall accuracy in % of the measurement range	±50 mV (-10 – +10 V) ±80 μA (-20 – +20 mA) ±76 μA (4 – 20 mA) ±4.2 °C (-180 – +600 °C)	—	±30 mV (0 – +10 V)																				
Max. conversion time	50 ms/channel	1 ms/4 channels	1 ms/channel																				
Isolation	Optocoupler isolation between input terminals and internal power																						
Connection terminal	All modules can be fitted with screw type or cache clamp terminal blocks (see accessories).																						
External sensor/actor supply	24 V DC (≤50 mA)	24 V DC (≤50 mA)	24 V DC (≤120 mA)																				
Applicable wire size	mm ² 0.75 – 1,5	0.75 – 1,5	0.75 – 1,5																				
Internal power consumption (8 V DC)	mA 80	60	60																				
Weight	kg 0.225	0.225	0.22																				
Dimensions (W x H x D)	mm 76 x 114 x 60	56 x 114 x 60	76 x 114 x 60																				
Order information	Art. no. 68909	124643	68912																				
Accessories	Terminal blocks Screw type terminal block MT-4AD-TBS, no. 68910 Cache clamp terminal block MT-4AD-TBC, no. 68911	Screw type terminal block MT-4DA-TBS, no. 124645 Cache clamp terminal block MT-4DA-TBC, no. 124644	Screw type terminal block MT-4DAV-TBS, no. 68913 Cache clamp terminal block MT-4DAV-TBC, no. 68914																				

■ PROFIBUS/DP MC Modules

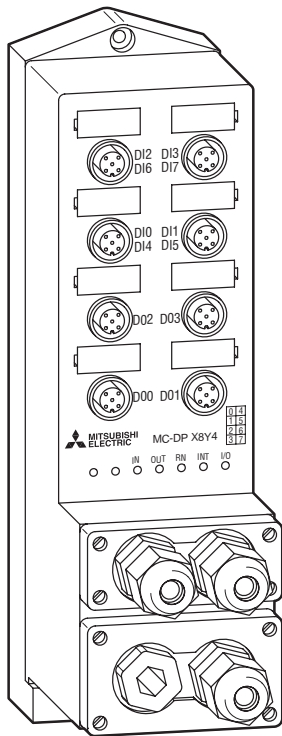

Digital input, output, and combined modules acc. to IP67

The digital I/O modules of the MC series support the evaluation of process signals (contacts, limit switches, etc.) directly on the machine via a PROFIBUS/DP master. The sensors and actuators are connected via plug-type/screw terminals.

Different modules with 16 inputs max. and 8 outputs max. as well as a combined I/O module with 8 inputs and 4 outputs are available.

Special features:

- The driving power for the sensors and actuators is supplied directly on the module.
- Connection of the sensory circuits in 3-wire cabling.
- Standard electrical isolation between process and control via optocoupler.
- Overload and short-circuit protection.

Specifications	MC-DPX8	MC-DPX16	MC-DPY8	MC-DPX8Y4
Inputs	8	16	—	8
Outputs	—	—	8	4
Output type	—	—	Transistor	Transistor
Isolation	Optocoupler isolation between input terminals and internal power			
Input voltage (sensor supply)	24 V DC (±25 %)	24 V DC (±25 %)	24 V DC (±25 %)	24 V DC (±25 %)
Rated output voltage	—	—	24 V DC (-1 %)	24 V DC (-1 %)
Output voltage (actor supply)	—	—	24 V DC (±25 %)	24 V DC (±25 %)
Max. switching voltage	A —	—	2	2
Max. input current	A < 0.1	<0.1	—	<0.1
Max. current	A —	—	2	2
per output	A —	—	10 at 0–55 °C, 16 at 0–40 °C	10 bei 0–55 °C, 16 bei 0–40 °C
per group	A —	—	—	—
Leakage current at OFF	—	—	<10 µA	<10 µA
Response time	ms	ms	ms	ms
OFF → ON	1	1	0.5	0.5
ON → OFF	1	1	0.5	0.5
Short circuit protection	Electronic	Electronic	Electronic	Elektronisch
Status display for outputs	All modules have one status LEDs per output.			
Error indicator	LED	LED	LED	—
I/O points	8	16	8	16
Connection terminal	All modules can be fitted with screw type or cache clamp terminal blocks.			
Applicable wire size	mm ² 0.75 – 2.5	0.75 – 2.5	0.75 – 2.5	—
External sensor/actor supply	24 V DC (≤100 mA)	24 V DC (≤100 mA)	24 V DC (≤100 mA)	24 V DC (≤100 mA)
Internal power consumption (8 V DC)	mA 80	80	80	80
Weight (without terminal block)	kg 0.47	0.47	0.47	0.47
Dimensions (W x H x D)	mm 62 x 217.5 x 70.5	62 x 217.5 x 70.5	62 x 217.5 x 70.5	62 x 217.5 x 70.5
Order information	Art.-Nr. 127208	127211	127209	127210



DeviceNet Network

Data Communications

The DeviceNet represents a cost-effective solution for the network integration of low-level terminal equipment. Up to 64 devices including a master can be integrated in one network.

Structure

Due to the supported tree structure of the data line, a T-junction can be installed in any place. It has to be considered that the overall extension must not exceed 500 m. Using repeaters increases the overall extension to 3 km.

Cable types

For the data exchange a cable with two shielded twisted-pair cables is used.

Parameterization

Parameterization is done with the configuration software SyCon from Ver. 2.0.6.2 by the Hilscher company.

Communications

The bus accessing method CSMA/NDA ensures an extremely fast and efficient access of the link devices to the bus.

Based on the Producer/Consumer network model this method ensures greater determinism of all data.

The slave modules communicate via the following methods:

- Polling
- Bit strobe
- Change of state
- Cyclic

Information at a size of 8 bytes per data packet can be transmitted. Packets exceeding these 8 bytes are fragmented automatically.

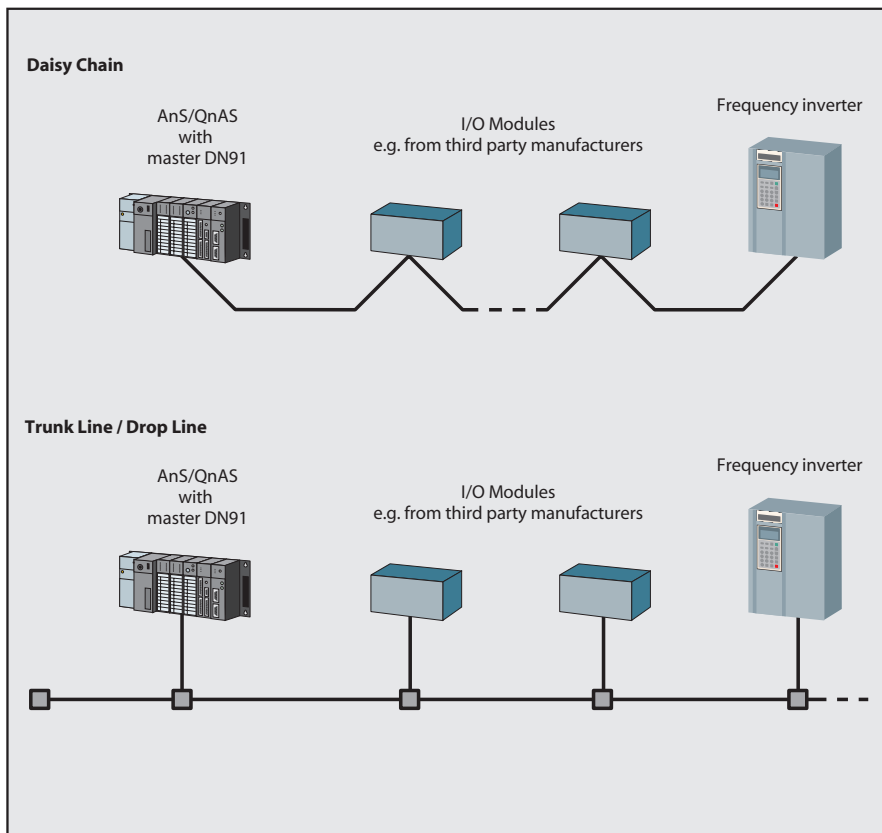

Cabel		Thick Cable	Thin Cable
Outline diameter	mm	12.2	6.9
Inside wire for data (blue / white)		18AWG19x30 zinc plated	24AWG19x36 zinc plated
Inside wire for power supply (red / black)		15AWG19x28 zinc plated	22AWG19x34 zinc plated
Trunkline		Yes	Yes
Dropline		Yes	Yes
Max. distance	m	500	500
Max. distance incl. Repeater	m	3000	3000

■ DeviceNet Master Module

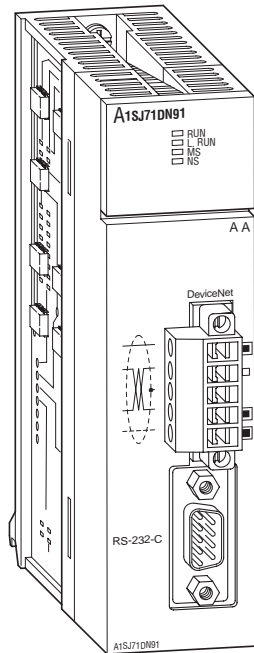

CAN based network for low level terminals

The DeviceNet represents a cost-effective solution for the network integration of low-level terminal equipment. Up to 64 devices including a master can be integrated in one network.

Special features:

- Up to 64 devices including a master station can be configured within one network.
- The positions of master and slave stations are user-selectable.
- Transfer rates of 125, 250 and 500 kBaud.
- Distances of up to 500 m.
- Communication methods
 - Polling
 - Bit strobe
 - Change of state
 - Cyclic

Specifications		A1SJ71DN91	
Module type		Master	
Applicable PLC series		MELSEC AnS/QnAS series	
Nodes per network		Group 2 Client	
Stations per network		0 up to 63	
Max. number of slave stations		63	
Communi- cations volume	I/O communication	2048 addresses (256 bytes)	
	Message communication	240 bytes	
Communica- tion speed	Cabel length	500 m	125 kBaud
		250 m	250 kBaud
		100 m	500 kBaud
Network power consumption	mA	26.5	
I/O points		32	
Internal power consumption (5 V DC)	mA	240	
Weight	kg	0.23	
Dimensions (W x H x D)	mm	130 x 34.5 x 93.6	
Order information	Art.-No.	124373	
Accessories		Configuration software SyCon from Fa. Hilscher	



The Network with Actuator Sensor Interface

Data transfer

The AS interface is an international standard for the lowest field bus level.

The network suits versatile demands, is very flexible and particularly easy to install.

Controlled are

- Sensors
- Actors
- I/O units
- Gateways

Structure

ASI networks can be configured in any random tree structure.

Up to 2 repeaters are supported providing a maximum communication distance of 300 m. Terminating resistors are not needed.

Cable types

A special coded 2-wire cable or a round cable is required.

When using a flat cable the modules are connected to the cable via push-through connections while the coding ensures a reverse protection.

Data exchange

The AS interface supports the connection of conventional sensors and actors following the master-slave principle.

Administration

The I/O points are assigned electronically through the bus connection or through the PLC program of the AnS/QnAS controller.

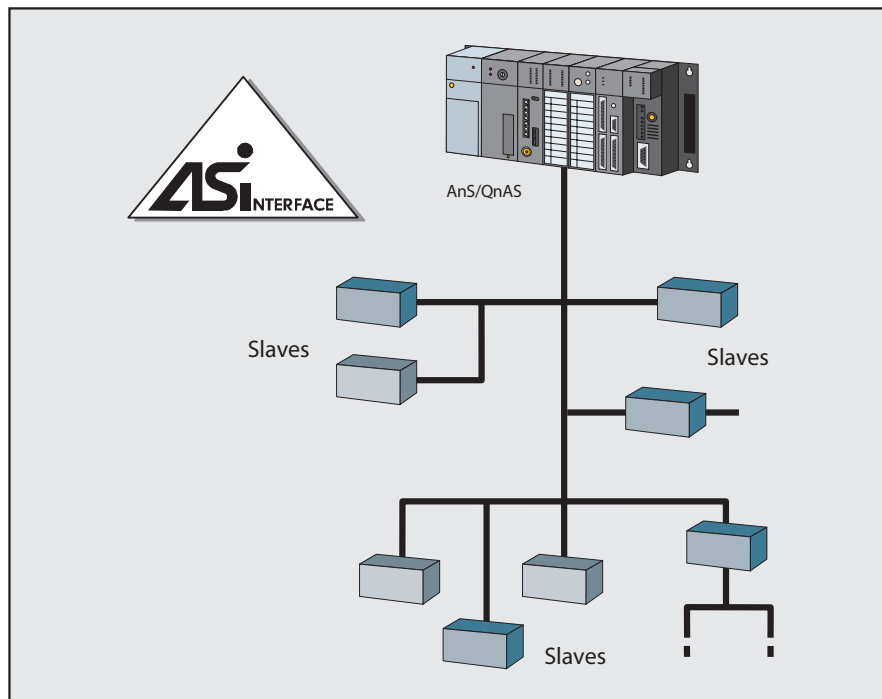

Specifications	AS interface
Network management	Master/Slave
Cabling	Coded twisted-pair cable (unshielded)
Data transfer rate	kBit/s 167
Bus cycle time	≤5 ms
Max. overall distance	m 100 (300 with Repeater)
Slave units per master	31
Repeaters per network	2

AS Interface Module A1SJ71AS92

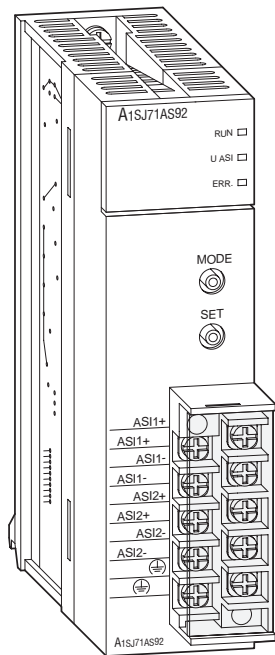

AS Interface master for AnS-/QnAS-CPU

The A1SJ71AS92 serves as master module for the connection of the AnS/QnAS series to the AS Interface system.

The A1SJ71AS92 can control up to 62 slave units (31 per channel) with up to 4 inputs and 4 outputs each per address. The addresses of the slave devices across the AS Interface are assigned automatically by the master.

Special features:

- Up to 62 slave units can be configured across two networks.
- Up to 496 digital inputs/outputs can be driven via the master.
- Communications via AS-I conform coded flat cable or round cable
- Highly efficient error securing system
- Automatic data exchange with the PLC

Specifications	A1SJ71AS92	
Module type	Master	
Application range	MELSEC AnS/QnAS series	
Max. number of slave stations to be controlled	31 x 2	
Assignable I/O points	Max. 2 x 124 inputs, 2 x 124 outputs	
Data transfer rate	167 kBaud	
I/O refresh time	Max. 5 ms	
Communications method	APM modulation	
Error handling	Parity check	
Transmission	method	Bus
	distance	100 m (300 m with repeater)
ASI network cable	Acc. to IEC62026-2 (yellow cable), round cable	
Assigned I/O points	32	
External power supply	ASI power supply (30.5 V DC)	
Power consumption	mA 100	
Weight	kg 0.3	
Dimensions (W x H x D)	mm 130 x 34.5 x 93.6	
Order information	Art. no. 129936	
Accessories	External AS-I power supply: ASI-PS-2.8, art. no.: 130259	



MELSEC AnS Pulse Catch Module

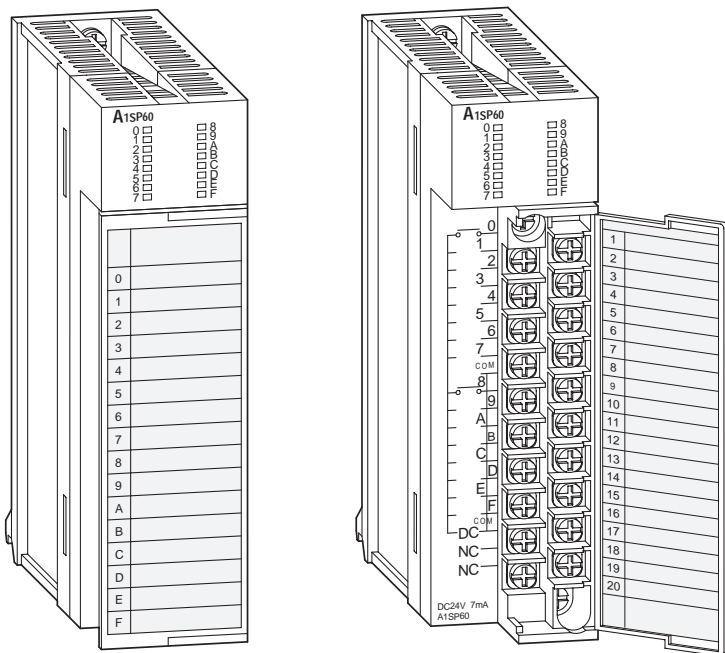

Digital pulse catch

The A1SP60 is a digital input module capable of detecting narrow pulses independently of the program cycle time.

Special features:

- Possibility of working with pulse function or with normal input function
- In the case of the pulse function, it is ensured that a signal applied at the input (>0.5 ms) is caught.
- By means of DIP switches, it is possible to specify, in groups of 4 input points, whether they are used as normal input points or with pulse catch.
- Galvanic isolation between process and controller by means of a photocoupler is a standard feature

Specifications		A1SP60
Input points		16
Rated input voltage	V DC	24
Operating voltage range	V DC	19.2 – 26.4
Max. input points simultaneous ON		100 %
Input	resistance	k Ω ca. 3.3
	current	mA ca. DC 7
Switch ON	voltage	V \geq DC 13
	current	mA \geq DC 3.5
Switch OFF	voltage	V \leq DC 6.5
	current	mA \leq DC 1.7
Response time	OFF \rightarrow ON	ms \leq 0.5
	ON \rightarrow OFF	ms \leq 1.0
Min. input pulse width	ms	0.5
Status display of inputs		LED
Isolation		All modules fitted with photocoupler isolation between input terminals and internal circuit.
No. of occupied I/O points		16
Connection terminal		The module is fitted with a terminal block with 20 screw terminals.
Applicable wire size	mm ²	0.75 – 1.5
Internal power consumption (5 V DC)	mA	55
Weight	kg	0.19
Dimensions (W x H x D)	mm	34.5 x 130 x 93.6
Order information	Art. no.	33197

MELSEC AnS Interrupt Module

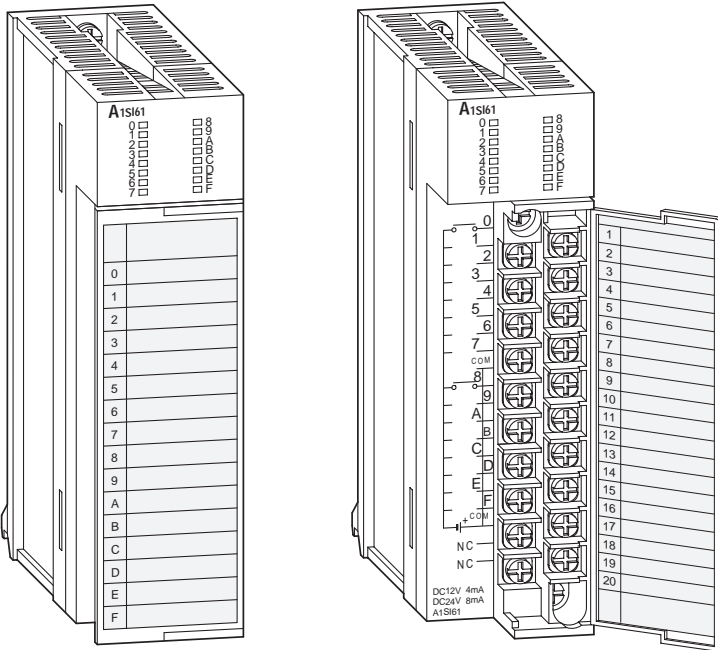

Branching to subroutines

The A1S161 is suitable for applications in which it is necessary to respond very rapidly to events.

Special features:

- Every input in this module is assigned a pointer which serves as a branch mark for a subroutine.
- If an interrupt/alarm signal is applied at an input, the PLC program is interrupted after it has worked through the current statement and a subroutine assigned to the input is first processed.
- Galvanic isolation between process and controller by means of an photocoupler is a standard feature
- Only one A1S161 can be installed to one PLC system

Specifications		A1S161	
Input points		16	
Rated input voltage	V DC	12 / 24	
Operating voltage range	V DC	10.2 – 26.4	
Max. input points simultaneous ON		100 %	
Input	resistance	k Ω	ca. 2.7
	current	mA	ca. DC 4 / 8
ON	voltage	V	\geq DC 9
	current	mA	\geq DC 3
OFF	voltage	V	\leq DC 4
	current	mA	\leq DC 1
Response time	OFF \rightarrow ON	msec	\leq 0.2
	ON \rightarrow OFF	msec	\leq 0.2
Status display of inputs		LED	
Isolation method		All modules fitted with photocoupler isolation between input terminals and internal circuit.	
No. of occupied I/O points		32	
Connection terminal		The module is fitted with a terminal block with 20 screw terminals.	
Applicable wire size	mm ²	0.75 – 1.5	
Internal power consumption (5 V DC)	mA	57 (all points ON)	
Weight	kg	0.2	
Dimensions (W x H x D)	mm	34.5 x 130 x 93.6	
Order information	Art. no.	33195	



■ MELSEC AnS Dummy Modules

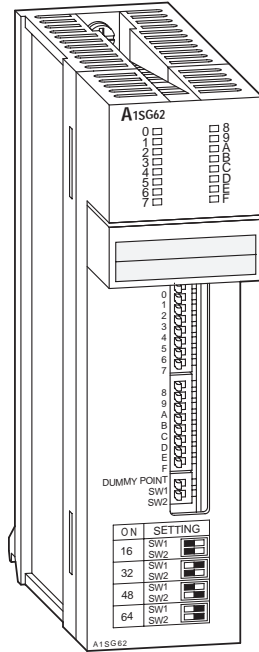

Place keeper and mechanical protection

The dummy modules protect unused slots on the base unit from foreign bodies and reserve I/O addresses.

Special features:

- The A1SG62 has 16 simulation switches by means of which digital inputs can be set and reset.
- Indication of the status of the inputs/outputs by means of LEDs.

Specifications	A1SG60	A1SG62
I/O points	16	Max. 64 (16, 32, 48 or 64 can be selected by DIP-switches)
Application	Used to protect any vacant slot from dust.	Used to reserve I/O points for a later to install I/O module.
Current consumption	mA —	60
Weight	kg 0.08	0.13
Dimensions (W x H x D)	mm 34.5 x 130 x 93.6	34.5 x 130 x 93.6
Order information	Art. no. 26596	30030

■ Connection Cable

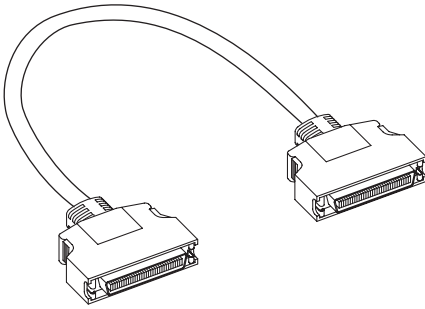

Connection cable for subracks

The connection cables A1SC01B, A1SC03B, A1SC012B and A1SC30B are used for connecting main base units to the extension base units. They have been cut to the correct length for each application.

The A1SC05NB cable is used for connecting MELSEC A series extension base units to AnS/QnAS series main base units. Connection of a base unit of the AnS/QnAS series to an A870GOT operator panel is also possible.

Specifications		A1SC01B	A1SC03B	A1SC12B	A1SC30B	A1SC60B	A1SC05NB
For extension base units	type	MELSEC AnS/QnAS	MELSEC AnS/QnAS	MELSEC AnS/QnAS	MELSEC AnS/QnAS	MELSEC AnS/QnAS	MELSEC A to AnS/QnAS, AnS/QnAS to A870GOT
Length	mm	55	330	1200	3000	6000	450
Ohmic resistance R of the cable	Ω	0.020	0.021	0.055	0.121	0.182	0.037
Order information	Art. no.	24979	24980	24981	24982	68294	24983

■ Adapter Cable

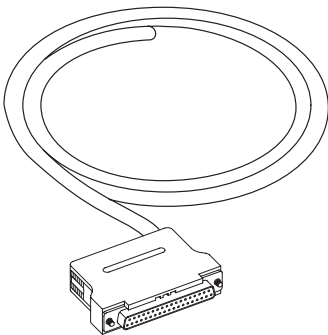

Assembled cable with D-SUB plug

The cable A32CBL is used for connecting the modules AX82 and AY82 of the MELSEC A series and the modules A1SX81 and A1SY81 of the MELSEC AnS series.

Specifications		A32CBL	A32CBL-5m
Connection cable for	type	AX82, AY82 (MELSEC A), A1SX81, A1SY81 (MELSEC AnS)	AX82, AY82 (MELSEC A), A1SX81, A1SY81 (MELSEC AnS)
Inputs/outputs		32	32
Length	m	3	5
Order information	Art. no.	3895	56052

■ Interface Converter CR01-R2/R4 SET and CR01-R4/R4

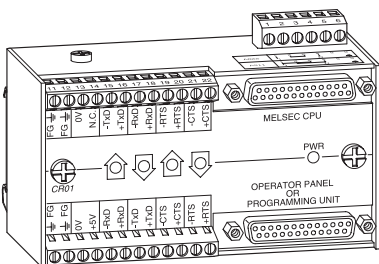

This module is a signal amplifier with photocoupler isolation for RS422 signals. It is used to connect a PLC with external devices like operation panels or a personal

computer, especially when a potential isolation is required and when the wiring length takes more than 15 meters.

Specifications		CR01-R4/R4	CR01-R2/R4 SET
Interface converter		RS422 ↔ RS422	RS422 ↔ RS232
Order information	Art. no.	56173	56172

MELSEC AnS Memory Cassettes

MELSEC AnS memory cassettes

The AnSCPU all have a permanently installed RAM with 8 k, 14 k, 30 k or 60 k steps. EPROM and EEPROM memory cassettes are available for permanent storage.

The EPROMs are programmed via the A6WA-28P (A1SNMCA-8KP) or A2SWA-28P (A2SNMCA-□□KP) with the aid of MELSEC MEDOC *plus*.

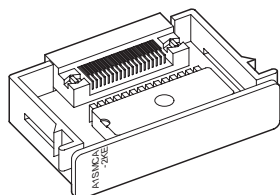

Specifications		A1SNMCA-2KE	A1SNMCA-8KE	A1SNMCA-8KP	A2SMCA-14KP	A2SNMCA-30KE	A2SMCA-30KP	A2SMCA-60KE
Memory cassette	type	EEPROM	EEPROM	EPROM	EPROM	EEPROM	EPROM	EPROM
For CPU type		A1SH	A1SH	A1SH	A2SH	A2SH	A2AS	A2AS
Memory capacity	kbyte	8	20	20	32	64	64	128
	instructions	2 k	8 k	8 k	14 k	30 k	30 k	60 k
Order information	Art. no.	68835	68834	68832	38066	68831	54922	68000

MELSEC AnS Adapter Units

EPROM write adapter

The write adapters A2 SWA-28P and A6 WA-28P are used for writing on the memory cassettes A2S(N)MCA-□□KP and A1SMCA-□□ of the MELSEC AnS series.

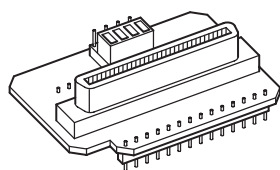

Specifications		A2 SWA-28P	A6 WA-28P
For memory cassettes	type	A2SMCA-14KP/30KP	A1SMCA-8KP
Order information	Art. no.	38069	24987

MELSEC QnAS Memory Cards

MELSEC QnAS memory cards

The QnASCPUs all have a permanently installed RAM. This memory can be extended with a variety of PCMCIA-memory cards.

The combination cards (with two memory types) have a non-volatile EEPROM memory which is programmable by MELSEC MEDOC *plus*.



Specifications		Q1MEM-1MS	Q1MEM-2MS	Q1MEM-256SE	Q1MEM-512SE	Q1MEM-1MSE
Memory	type	Card	Card	Card	Card	Card
Memory capacity		1 MB SRAM	2 MB SRAM	128 kB SRAM, 128 kB EEPROM	256 kB SRAM, 256 kB EEPROM	512 kB SRAM, 512 kB EEPROM
Order information	Art. no.	64197	64196	64193	64204	68031

■ Battery A6BAT

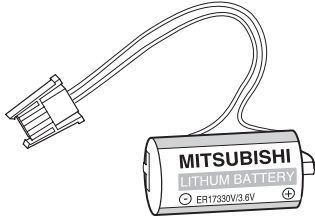

The A6BAT lithium cell battery is already installed in every MELSEC A series memory cassette.

The battery protects the data in the cassette RAM when the power supply is

switched off or in the event of power failures. It has a service life of around five years.

Specifications		A6BAT
Voltage	V DC	3,6
Backup time during power failure		A3NMCA-0 : 10800 h A3NMCA-40: 1400 h
Dimensions (Ø x H)	mm	Ø16 x 30
Order information		Art. no 4077

■ Fuses

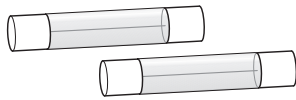

The output modules A1SY22, A1SY80 and A1SY81 are equipped with dedicated fuses for device protection.

Specifications	HM50C	LM50	LM32
For module	A1SY22	A1SX80	A1SY81
Rating	5 A	5 A	3.2 A
Type	Solder fuse	Plug fuse	Plug fuse
Order information		Art. no 38361	32301 32303

■ Dust Cover



If I/O devices are mounted on an extension base unit, then the first module on the extension base unit should be equipped with a dust cover.

Specifications		Dust Cover
Material		Plastics
Dimensions (W x H)	mm	44 x 129
Order information		Art. no. 32299



Local System Extension Set for the MT Series

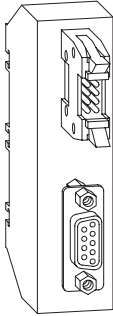

For the extension of the MT series to a second connecting level the local system extension MT-LE and the connecting cable MT-LE-CBL50 are required.

The extension and the cable are available only as complete set, which is called MT-LE-SET.

Specifications		MT-LE-SET
Application		MT series
Cable length	m	0.5
Dimensions (W x H x D)	mm	22.5 x 97 x 36
Order information		Art. no. 69759

ProfiConT Profibus Connector

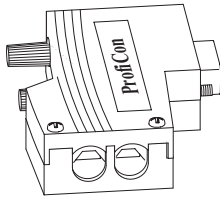

The ProfiCon bus connector plug is designed for connecting DIN 19245 standard Profibus components with data transfer rates of up to 12 Mbaud.

The connector is available with a selectable termination resistor.

Specifications		ProfiConT
Data rate 12 Mbit/s		supported
Terminator		Yes (selectable)
Order information		Art. no. 87035



MELSEC AnS/QnAS Power Supply Modules

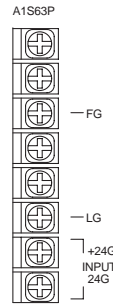
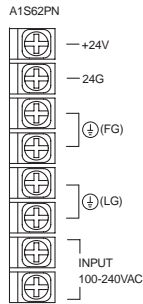
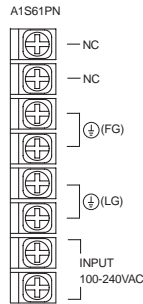
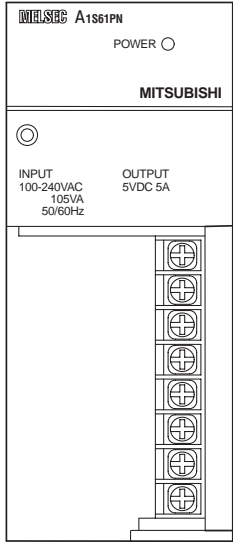

MELSEC AnS/QnAS Digital Input Modules

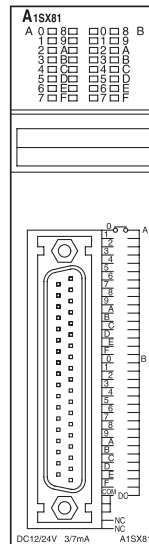
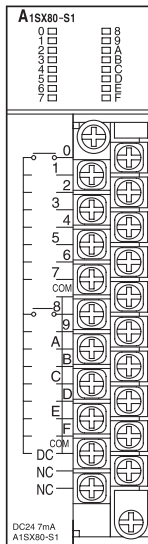
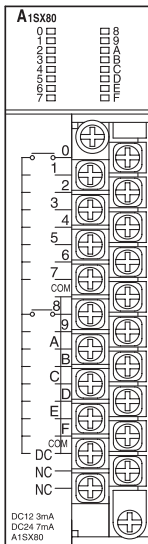
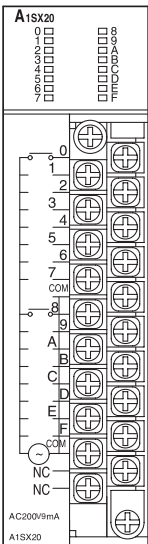
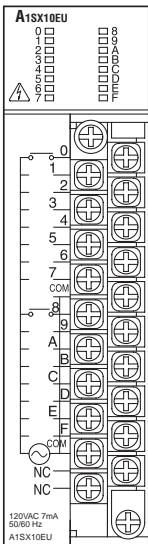

MELSEC AnS/QnAS Digital Output Modules

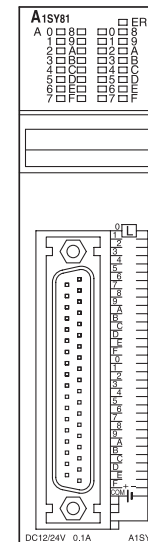
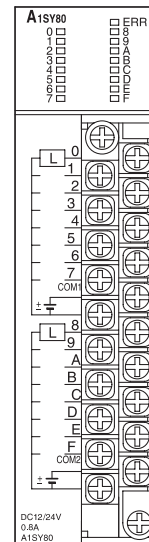
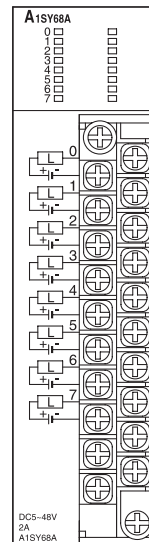
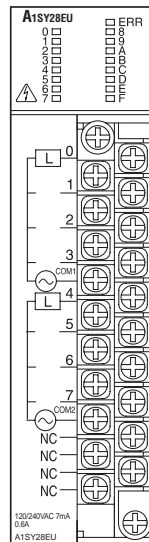
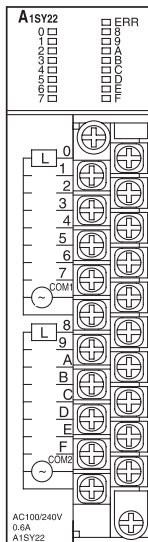
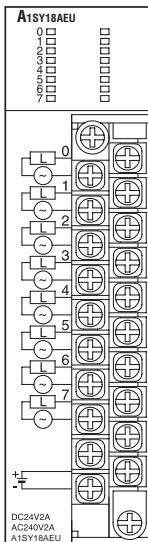
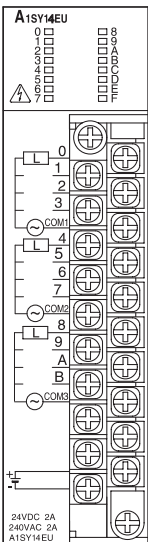
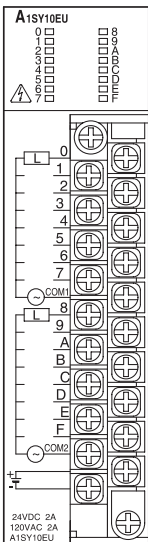

MELSEC AnS Analog Input/Output Modules

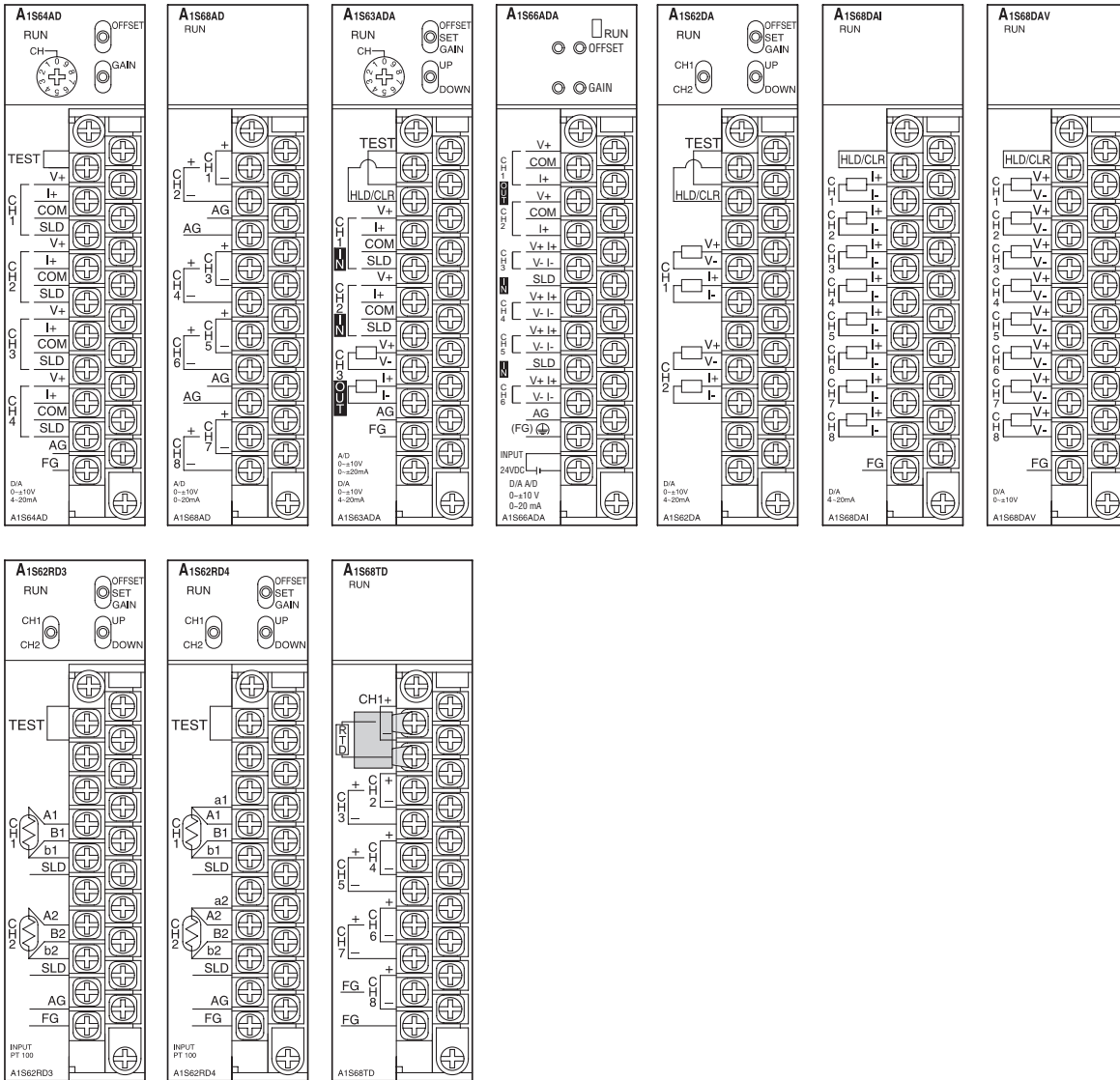

MELSEC AnS Counter, Timer and Positioning Modules

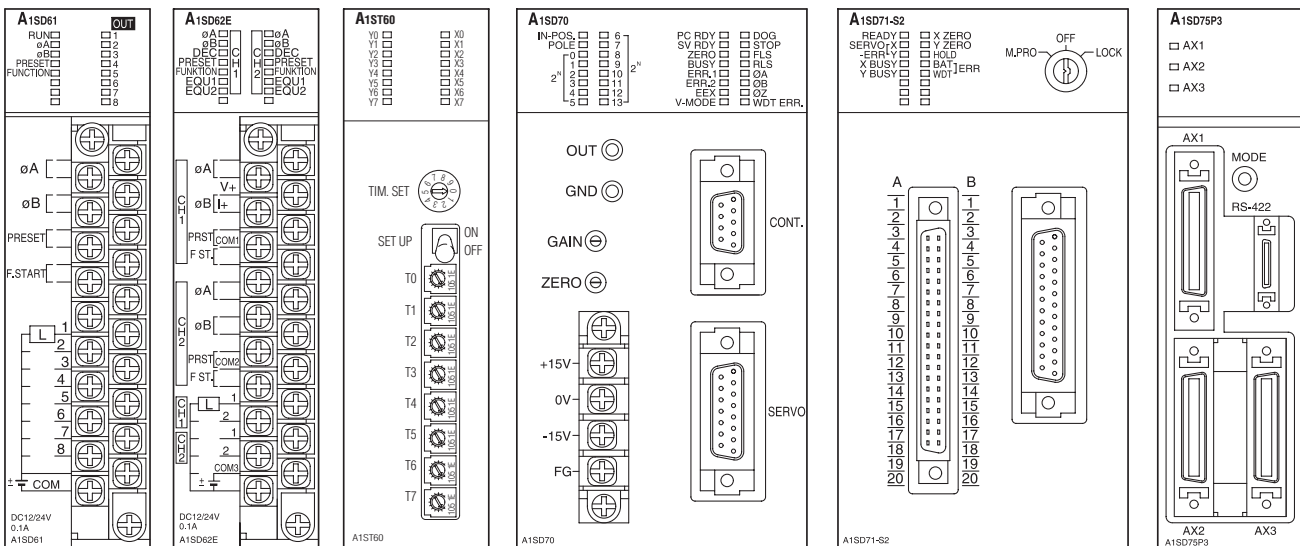

MELSEC AnS/QnAS Interface Modules

<p>A1S71UC24-R2</p> <p>RUN <input type="checkbox"/> NEU <input type="checkbox"/> ACK <input type="checkbox"/> SIO <input type="checkbox"/> C/N <input type="checkbox"/> P/S <input type="checkbox"/> MD <input type="checkbox"/> ST.DWN <input type="checkbox"/> COM <input type="checkbox"/> MD/L</p> <p>SW 01 02 03 04</p> <p>MODE 1:FORM1 2:FORM2 3:FORM3 4:FORM4 5:NOFORM</p> <p>RS-232-C</p> <p>A1S71UC24-R2</p>	<p>A1S71UC24-R4</p> <p>RUN <input type="checkbox"/> NEU <input type="checkbox"/> SCAN <input type="checkbox"/> ACK <input type="checkbox"/> SET E. <input type="checkbox"/> SIO <input type="checkbox"/> C/N <input type="checkbox"/> P/S <input type="checkbox"/> MD <input type="checkbox"/> ST.DWN <input type="checkbox"/> COM <input type="checkbox"/> MD/L</p> <p>STATION NO. X10 X1</p> <p>MODE 1:FORM1 2:FORM2 3:FORM3 4:FORM4 5:NOFORM</p> <p>SDA SDB RDA RDB SG FG NC</p> <p>RS-422/485</p> <p>A1S71UC24-R4</p>	<p>A1S71C24-PPF</p> <p>RUN <input type="checkbox"/> NEU <input type="checkbox"/> ACK <input type="checkbox"/> SIO <input type="checkbox"/> C/N <input type="checkbox"/> P/S <input type="checkbox"/> MD <input type="checkbox"/> ST.DWN <input type="checkbox"/> COM <input type="checkbox"/> MD/L</p> <p>SW 03 04</p> <p>MODE 1:FORM1 2:FORM2 3:FORM3 4:FORM4 5:NOFORM</p> <p>RS-232-C</p> <p>A1S71C24-PPF</p>	<p>A1S71UC24-R2-S2</p> <p>RUN <input type="checkbox"/> NEU <input type="checkbox"/> ACK <input type="checkbox"/> SIO <input type="checkbox"/> C/N <input type="checkbox"/> P/S <input type="checkbox"/> MD <input type="checkbox"/> ST.DWN <input type="checkbox"/> COM <input type="checkbox"/> MD/L</p> <p>SW 03 04</p> <p>MODE 1:FORM1 2:FORM2 3:FORM3 4:FORM4 5:NOFORM</p> <p>RS-232-C</p> <p>A1S71UC24-R2-S2</p>	<p>A1S71UC24-R4-S2</p> <p>RUN <input type="checkbox"/> NEU <input type="checkbox"/> SCAN <input type="checkbox"/> ACK <input type="checkbox"/> SET E. <input type="checkbox"/> SIO <input type="checkbox"/> C/N <input type="checkbox"/> P/S <input type="checkbox"/> MD <input type="checkbox"/> ST.DWN <input type="checkbox"/> COM <input type="checkbox"/> MD/L</p> <p>STATION NO. X10 X1</p> <p>MODE 1:FORM1 2:FORM2 3:FORM3 4:FORM4 5:NOFORM</p> <p>SDA SDB RDA RDB SG FG NC</p> <p>RS-422/485</p> <p>A1S71UC24-R4-S2</p>	<p>A1S710C24-R2</p> <p>RUN <input type="checkbox"/> NEU <input type="checkbox"/> ACK <input type="checkbox"/> SIO <input type="checkbox"/> C/N <input type="checkbox"/> P/S <input type="checkbox"/> MD <input type="checkbox"/> ST.DWN <input type="checkbox"/> COM <input type="checkbox"/> MD/L</p> <p>ERR C/W <input type="checkbox"/> ERR C/N <input type="checkbox"/> ERR P/S <input type="checkbox"/> ERR MD <input type="checkbox"/> ERR ST.DWN <input type="checkbox"/> ERR COM <input type="checkbox"/> ERR MD/L</p> <p>DISPLAY STS <input type="checkbox"/> ERR</p> <p>STATION NO. X10 X1</p> <p>MODE 1:FORM1 2:FORM2 3:FORM3 4:FORM4 5:NOFORM</p> <p>CH1/2 CH2/2</p> <p>RS-232-C</p> <p>A1S710C24-R2</p>	<p>A1S710C24</p> <p>RUN <input type="checkbox"/> NEU <input type="checkbox"/> ACK <input type="checkbox"/> SIO <input type="checkbox"/> C/N <input type="checkbox"/> P/S <input type="checkbox"/> MD <input type="checkbox"/> ST.DWN <input type="checkbox"/> COM <input type="checkbox"/> MD/L</p> <p>ERR C/W <input type="checkbox"/> ERR C/N <input type="checkbox"/> ERR P/S <input type="checkbox"/> ERR MD <input type="checkbox"/> ERR ST.DWN <input type="checkbox"/> ERR COM <input type="checkbox"/> ERR MD/L</p> <p>DISPLAY STS <input type="checkbox"/> ERR</p> <p>STATION NO. X10 X1</p> <p>MODE 1:FORM1 2:FORM2 3:FORM3 4:FORM4 5:NOFORM</p> <p>CH1/2 CH2/2</p> <p>RS-232-C</p> <p>A1S710C24</p>
--	--	--	--	--	---	---

MELSEC AnS/QnAS Communications Modules

<p>A1SD51S</p> <p>RUN <input type="checkbox"/> S.ERR <input type="checkbox"/> PROG <input type="checkbox"/> P1.RUN <input type="checkbox"/> P1.ERR <input type="checkbox"/> P2.RUN <input type="checkbox"/> P2.ERR <input type="checkbox"/> CH1 SD <input type="checkbox"/> CH1 RD <input type="checkbox"/> CH2 SD <input type="checkbox"/> CH2 RD <input type="checkbox"/> CH3 SD <input type="checkbox"/> CH3 RD <input type="checkbox"/> M.PRO. <input type="checkbox"/></p> <p>MODE RUN STOP RES.</p> <p>CH1(RS-232-C) SW</p> <p>CH2(RS-232-C) ON</p> <p>FRONT SIDE</p> <p>A1SD51S</p>	<p>A1SD51S-BAL</p> <p>RUN <input type="checkbox"/> S.ERR <input type="checkbox"/> PROG <input type="checkbox"/> P1.RUN <input type="checkbox"/> P1.ERR <input type="checkbox"/> P2.RUN <input type="checkbox"/> P2.ERR <input type="checkbox"/> CH1 SD <input type="checkbox"/> CH1 RD <input type="checkbox"/> CH2 SD <input type="checkbox"/> CH2 RD <input type="checkbox"/> CH3 SD <input type="checkbox"/> CH3 RD <input type="checkbox"/> M.PRO. <input type="checkbox"/></p> <p>MODE RUN STOP RES.</p> <p>CH1(RS-232-C) SW</p> <p>CH2(RS-232-C) ON</p> <p>FRONT SIDE</p> <p>A1SD51S-BAL</p>
---	---

MELSEC AnS/QnAS Communications Modules for Ethernet and MELSECNET4 Networks

<p>A1S71E71-B2-S3</p> <p>RUN <input type="checkbox"/> B1 <input type="checkbox"/> B2 <input type="checkbox"/> RDY <input type="checkbox"/> B4 <input type="checkbox"/> B5 <input type="checkbox"/> B6 <input type="checkbox"/> B7 <input type="checkbox"/> B8</p> <p>RAM CHK <input type="checkbox"/> RAM ERR. <input type="checkbox"/> ROM CHK <input type="checkbox"/> ROM ERR. <input type="checkbox"/> S.C. <input type="checkbox"/> S.C.ERR. <input type="checkbox"/> COM.ERR. <input type="checkbox"/> FROM/TO</p> <p>SW1 SW2 SW3 SW4</p> <p>MODE 0:ONLINE 1:OFFLINE 2:TEST1 3:TEST2 4:TEST3</p> <p>10BASE2</p> <p>A1S71E71-B2-S3</p>	<p>A1S71E71-B5-S3</p> <p>RUN <input type="checkbox"/> B1 <input type="checkbox"/> B2 <input type="checkbox"/> RDY <input type="checkbox"/> B4 <input type="checkbox"/> B5 <input type="checkbox"/> B6 <input type="checkbox"/> B7 <input type="checkbox"/> B8</p> <p>RAM CHK <input type="checkbox"/> RAM ERR. <input type="checkbox"/> ROM CHK <input type="checkbox"/> ROM ERR. <input type="checkbox"/> S.C. <input type="checkbox"/> S.C.ERR. <input type="checkbox"/> COM.ERR. <input type="checkbox"/> FROM/TO</p> <p>SW1 SW2 SW3 SW4</p> <p>MODE 0:ONLINE 1:ONLINE 2:TEST1 3:TEST2 4:TEST3</p> <p>AUI</p> <p>+12V 12G FG</p> <p>A1S71E71-B5-S3</p>	<p>A1S710E71-B2</p> <p>RUN <input type="checkbox"/> B1 <input type="checkbox"/> B2 <input type="checkbox"/> RDY <input type="checkbox"/> B4 <input type="checkbox"/> B5 <input type="checkbox"/> B6 <input type="checkbox"/> B7 <input type="checkbox"/> B8</p> <p>CPU RW <input type="checkbox"/> TRAN. S <input type="checkbox"/> TRAN. R <input type="checkbox"/> FTP <input type="checkbox"/> SW ERR. <input type="checkbox"/> COM.ERR. <input type="checkbox"/> TEST <input type="checkbox"/> TEST ERR.</p> <p>SW1 SW2 SW3 SW4</p> <p>MODE 0:ONLINE 1:ONLINE 2:TEST1 3:TEST2 4:TEST3 5:TEST4</p> <p>10BASE2</p> <p>A1S710E71-B2</p>	<p>A1S710E71-B5</p> <p>RUN <input type="checkbox"/> B1 <input type="checkbox"/> B2 <input type="checkbox"/> RDY <input type="checkbox"/> B4 <input type="checkbox"/> B5 <input type="checkbox"/> B6 <input type="checkbox"/> B7 <input type="checkbox"/> B8</p> <p>CPU RW <input type="checkbox"/> TRAN. S <input type="checkbox"/> TRAN. R <input type="checkbox"/> FTP <input type="checkbox"/> SW ERR. <input type="checkbox"/> COM.ERR. <input type="checkbox"/> TEST <input type="checkbox"/> TEST ERR.</p> <p>SW1 SW2 SW3 SW4</p> <p>MODE 0:ONLINE 1:ONLINE 2:TEST1 3:TEST2 4:TEST3 5:TEST4</p> <p>10BASE2</p> <p>A1S710E71-B5</p>	<p>A1S71BR11</p> <p>RUN <input type="checkbox"/> MNG <input type="checkbox"/> S.MNG <input type="checkbox"/> D.LINK <input type="checkbox"/> T.PAS. <input type="checkbox"/> CPU RW <input type="checkbox"/> P.W <input type="checkbox"/> P.C <input type="checkbox"/> REM <input type="checkbox"/> SW.C <input type="checkbox"/> MS.E <input type="checkbox"/> P.M <input type="checkbox"/> SD <input type="checkbox"/> RD</p> <p>CRC OVER <input type="checkbox"/> ABJ.F <input type="checkbox"/> TIME <input type="checkbox"/> DATA <input type="checkbox"/> UNDER</p> <p>DISPLAY NETWORK NO. X100 X10 X1 GR.NO. ST.NO. X10 MODE</p> <p>A1S71BR11</p>	<p>A1S710BR11</p> <p>RUN <input type="checkbox"/> MNG <input type="checkbox"/> S.MNG <input type="checkbox"/> D.LINK <input type="checkbox"/> T.PAS. <input type="checkbox"/> CPU RW <input type="checkbox"/> P.W <input type="checkbox"/> P.C <input type="checkbox"/> REM <input type="checkbox"/> SW.C <input type="checkbox"/> MS.E <input type="checkbox"/> P.M <input type="checkbox"/> SD <input type="checkbox"/> RD</p> <p>CRC OVER <input type="checkbox"/> ABJ.F <input type="checkbox"/> TIME <input type="checkbox"/> DATA <input type="checkbox"/> UNDER</p> <p>DISPLAY NETWORK NO. X100 X10 X1 GR.NO. ST.NO. X10 MODE</p> <p>A1S710BR11</p>	<p>A1S71LP21</p> <p>RUN <input type="checkbox"/> MNG <input type="checkbox"/> S.MNG <input type="checkbox"/> D.LINK <input type="checkbox"/> T.PAS. <input type="checkbox"/> CPU RW <input type="checkbox"/> P.W <input type="checkbox"/> P.C <input type="checkbox"/> REM <input type="checkbox"/> SW.C <input type="checkbox"/> MS.E <input type="checkbox"/> P.M <input type="checkbox"/> SD <input type="checkbox"/> RD</p> <p>CRC OVER <input type="checkbox"/> ABJ.F <input type="checkbox"/> TIME <input type="checkbox"/> DATA <input type="checkbox"/> UNDER</p> <p>DISPLAY NETWORK NO. X100 X10 X1 GR.NO. ST.NO. X10 MODE</p> <p>A1S71LP21</p>	<p>A1S710LR21</p> <p>RUN <input type="checkbox"/> MNG <input type="checkbox"/> S.MNG <input type="checkbox"/> D.LINK <input type="checkbox"/> T.PAS. <input type="checkbox"/> CPU RW <input type="checkbox"/> P.W <input type="checkbox"/> P.C <input type="checkbox"/> REM <input type="checkbox"/> SW.C <input type="checkbox"/> MS.E <input type="checkbox"/> P.M <input type="checkbox"/> SD <input type="checkbox"/> RD</p> <p>CRC OVER <input type="checkbox"/> ABJ.F <input type="checkbox"/> TIME <input type="checkbox"/> DATA <input type="checkbox"/> UNDER</p> <p>DISPLAY NETWORK NO. X100 X10 X1 GR.NO. ST.NO. X10 MODE</p> <p>A1S710LR21</p>
--	--	---	---	---	---	---	---

MELSEC AnS/QnAS Communications Modules for MELSECNET Networks

A1S1J10LP21

RUN PW CRC

S LINK REM OVER

M.S.E. TIME AB.IF

D LINK DATA UNDER

T.PAS. R.E. RD

CPU RW

A1S1J20LP25

RUN PW CRC

DUAL HOLD OVER

U LINK TIME AB.IF

T.PAS. SWI. DATA

WAIT PRM. R.E. RD

A1S1J20BR-15

RUN PW CRC

HOLD OVER

U LINK TIME AB.IF

SWI. DATA

WAIT PRM. RD

A1S1J1AR21

RUN CRC

SD OVER

R.D. AB.IF

F.LOOP TIME

CPU DATA

R.W. UNDER

L. F.LOOP

R. R.LOOP

A1S1J1AT21B

CRC SD

OVER RD

AB.IF 125K

DATA 250K

DATA 500K

UND. 1M

A1S1J1PT32-S3

RUN F. RD

SD R. LOOP

C. RD R. REM.

U. WR 32

48

TEST

NETWORK NO. X10 X1

DISPLAY (FL) (RL)

RESET

MODE 0:ONLINE(A,R) 2:OFFLINE

FRONT SIDE

MODE

SDA SDB RDA RDB SG FG

SDA/RDA SDB/RDB SG(L) FG

MODE

BAUD RATE

SDA/RDA SDB/RDB SG(L) FG

FRONT SIDE

SD(OUT) RD(IN)

MELSEC AnS/QnAS Communications Modules for I/O-Link, Profibus, CC-Link, DeviceNet and AS Interface

A1S1S1T64

RUN SD ERROR

SD RD M.S.

READY LOCAL

FROM TO CPU RW

PRM SET L RUN

PARITY R ERR

7 RD

A1S1J1PB96F

RUN TEST

SD B6

RD B5

TOKEN B4

READY B3

FROM TO B2

PRM SET B1

PARITY B0

7 B0

A1S1J1PB92D

RUN TEST

SD B6

RD B5

TOKEN B4

READY B3

FROM TO B2

PRM SET B1

PARITY B0

7 B0

A1S1G1BT11

RUN SW

ERR M.S.

MST PRM

S.M.S.T. TIME

LOCAL CPU RW

CPU RW SD

L RUN RD

L ERR RD

A1S1G1BT11

RUN SW

ERR M.S.

MST PRM

S.M.S.T. TIME

LOCAL CPU RW

CPU RW SD

L RUN RD

L ERR RD

A1S1J1DN91

RUN DeviceNet

SD RS-232-C

RD

M.S.

ERR

A1S1J1AS92

RUN U ASI

ERR

MODE

SET

ASI1+ ASI1- ASI2+ ASI2-

NC ASI1+ ASI1- ASI2+ ASI2-

NC ASI1+ ASI1- ASI2+ ASI2-

MODE

0:ONLINE 1:PRM SET 2:TEST

RS-232-C

PROFIBUS I/F

BUS TERMINATION OFF ON

MODE

0:ONLINE 1:PRM SET 2:TEST

RS-232-C

PROFIBUS I/F

BUS TERMINATION OFF ON

MODE

0:ONLINE 1:PRM SET 2:TEST

RS-232-C

PROFIBUS I/F

BUS TERMINATION OFF ON

STATION NO. MODE

X10 X1

B RATE

0 156K 1 625K 2 250K 3 5M 4 10M

NC DA DB DG SLD (FG)

STATION NO. MODE

X10 X1

B RATE

0 156K 1 625K 2 250K 3 5M 4 10M

NC DA DB DG SLD (FG)

RS-232-C

DeviceNet

RS-232-C

MODE

SET

ASI1+ ASI1- ASI2+ ASI2-

NC ASI1+ ASI1- ASI2+ ASI2-

MELSEC AnS/QnAS Pulse Catch and Interrupt Modules, Co-Processor module

A1S1S1

0 1 2 3 4 5 6 7 8 9

DC12V 4mA DC24V 8mA

A1S1S1

A1SP60

0 1 2 3 4 5 6 7 8 9

DC24V 7mA

A1SP60

SPAC20

RUN X Y

WD TIME 0 1 2 3 4 5 6 7 8 9

WD OFF NO BUS W. START NO RD PS L

MB R RUN STOP RESET

SELECT

WD TIME 1 2 3 4 5 6

WD OFF NO BUS W. START NO RD PS L

RS-232C

SPAC20

A B A B

DC12V 4mA DC24V 8mA

A1S1S1

DC24V 7mA

A1SP60

WD TIME 1 2 3 4 5 6

WD OFF NO BUS W. START NO RD PS L

RS-232C

SPAC20

A B A B

MELSEC I/O Link Decentralised Digital Input/Output Modules

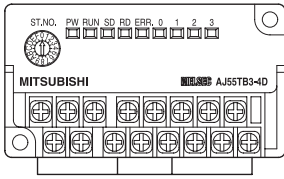

AJ55TB3-4D

1	3	5	7	9	11	13	15	
DATA	FG	+24V	(U24A)	X0	X1	X2	X3	
2	4		6	8	10	12	14	16
DG	24G		(U24B)	(COMB)	(COMA)	(COMB)	(COMA)	(COMB)

AJ55TB32-4DR

1	3	5	7	9	11	13	15	
DATA	FG	+24V	(U24A)	X0	X1	Y0	Y1	
2	4		6	8	10	12	14	16
DG	24G		(U24B)	(COMB)	(COMA)	(COM1)	(COM1)	(COM2)

AJ55TB2-4R

1	3	5	7	9	11	13	15	
DATA	FG	+24V	(U24V)	Y0	Y1	Y2	Y3	
2	4		6	8	10	12	14	16
DG	24G		(U24G)	(COM1)	(COM1)	(COM1)	(COM1)	(COM2)

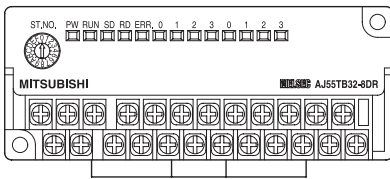

AJ55TB3-8D

1	3	5	7	9	11	13	15	17	19	21	23	
DATA	FG	+24V	(U24A)	X0	X1	X2	X3	X4	X5	X6	X7	
2	4		6	8	10	12	14	16	18	20	22	24
DG	24G		(U24B)	(COMB)	(COMA)	(COMB)	(COMA)	(COMB)	(COMA)	(COMB)	(COMA)	(COMB)

AJ55TB32-8DR

1	3	5	7	9	11	13	15	17	19	21	23	
DATA	FG	+24V	(U24A)	X0	X1	X2	X3	X4	X5	Y1	Y2	Y3
2	4		6	8	10	12	14	16	18	20	22	24
DG	24G		(U24B)	(COMB)	(COMA)	(COMB)	(COMA)	(COMB)	(COM1)	(COM1)	(COM1)	(COM2)

AJ55TB2-8R

1	3	5	7	9	11	13	15	17	19	21	23	
DATA	FG	+24V	(U24V)	Y0	Y1	Y2	Y3	Y4	Y5	Y6	Y7	
2	4		6	8	10	12	14	16	18	20	22	24
DG	24G		(U24G)	(COM1)	(COM1)	(COM1)	(COM1)	(COM1)	(COM1)	(COM1)	(COM1)	(COM2)

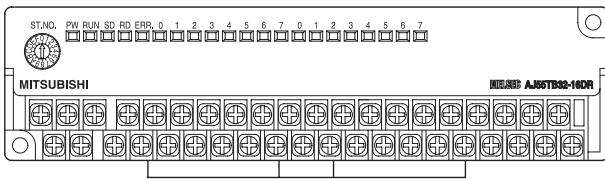

AJ55TB3-16D

1	3	5	7	9	11	13	15	17	19	21	23	25	27	29	31	33	35	37	39	
DATA	FG	+24V	(U24A)	X0	X1	X2	X3	X4	X5	X6	X7	X8	X9	XA	XB	XC	XD	XE	XF	
2	4		6	8	10	12	14	16	18	20	22	24	26	28	30	32	34	36	38	40
DG	24G		(U24B)	(COMB)	(COMA)	(COMB)	(COMA)	(COMB)	(COMA)	(COMB)	(COMA)	(COMB)	(COMA)	(COMB)	(COMA)	(COMB)	(COMA)	(COMB)	(COMA)	(COMB)

AJ55TB32-16DR

1	3	5	7	9	11	13	15	17	19	21	23	25	27	29	31	33	35	37	39	
DATA	FG	+24V	(U24A)	X0	X1	X2	X3	X4	X5	X6	X7	X8	X9	YA	YB	YC	YD	YE	YF	
2	4		6	8	10	12	14	16	18	20	22	24	26	28	30	32	34	36	38	40
DG	24G		(U24B)	(COMB)	(COMA)	(COMB)	(COMA)	(COMB)	(COMA)	(COMB)	(COM1)	(COM1)	(COM1)	(COM1)	(COM1)	(COM1)	(COM1)	(COM1)	(COM1)	(COM1)

AJ55TB2-16R

1	3	5	7	9	11	13	15	17	19	21	23	25	27	29	31	33	35	37	39	
DATA	FG	+24V	(U24V)	Y0	Y1	Y2	Y3	Y4	Y5	Y6	Y7	Y8	Y9	YA	YB	YC	YD	YE	YF	
2	4		6	8	10	12	14	16	18	20	22	24	26	28	30	32	34	36	38	40
DG	24G		(U24G)	(COM1)	(COM1)	(COM1)	(COM1)	(COM1)	(COM1)	(COM1)	(COM1)	(COM2)	(COM3)	(COM3)	(COM3)	(COM3)	(COM3)	(COM3)	(COM3)	(COM4)



Base Units

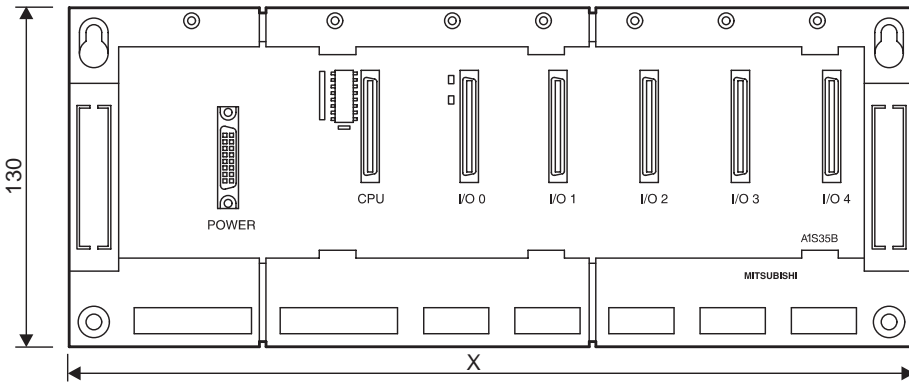

Type	X (in mm)
A1S32B-E	220
A1S33B-E	255
A1S35B-E	325
A1S38B-E	430
A1S38HB	430
A1S52B-S1	155
A1S55B-S1	260
A1S58B-S1	365
A1S65B-S1	315
A1S68B-S1	420

CPUs and Power Supply Modules

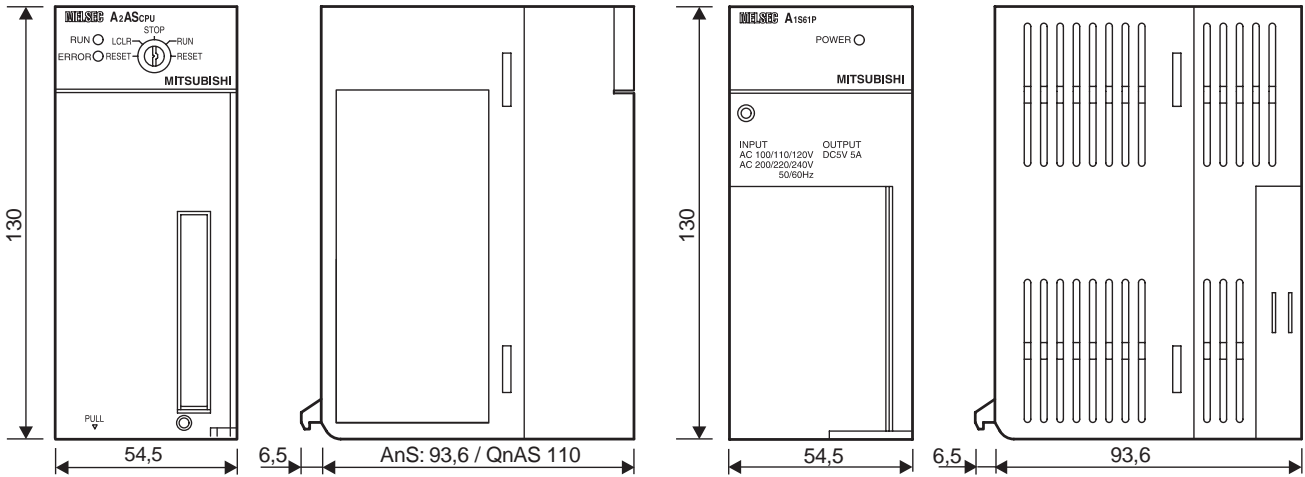

Digital and Special Function Modules

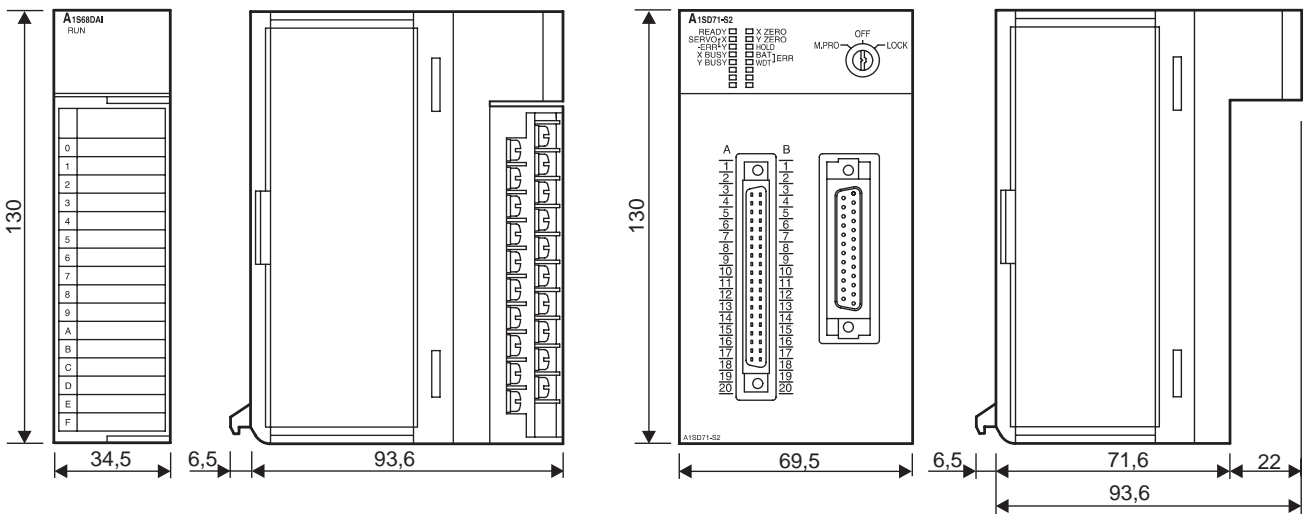

■ Profibus/DP MT Modules

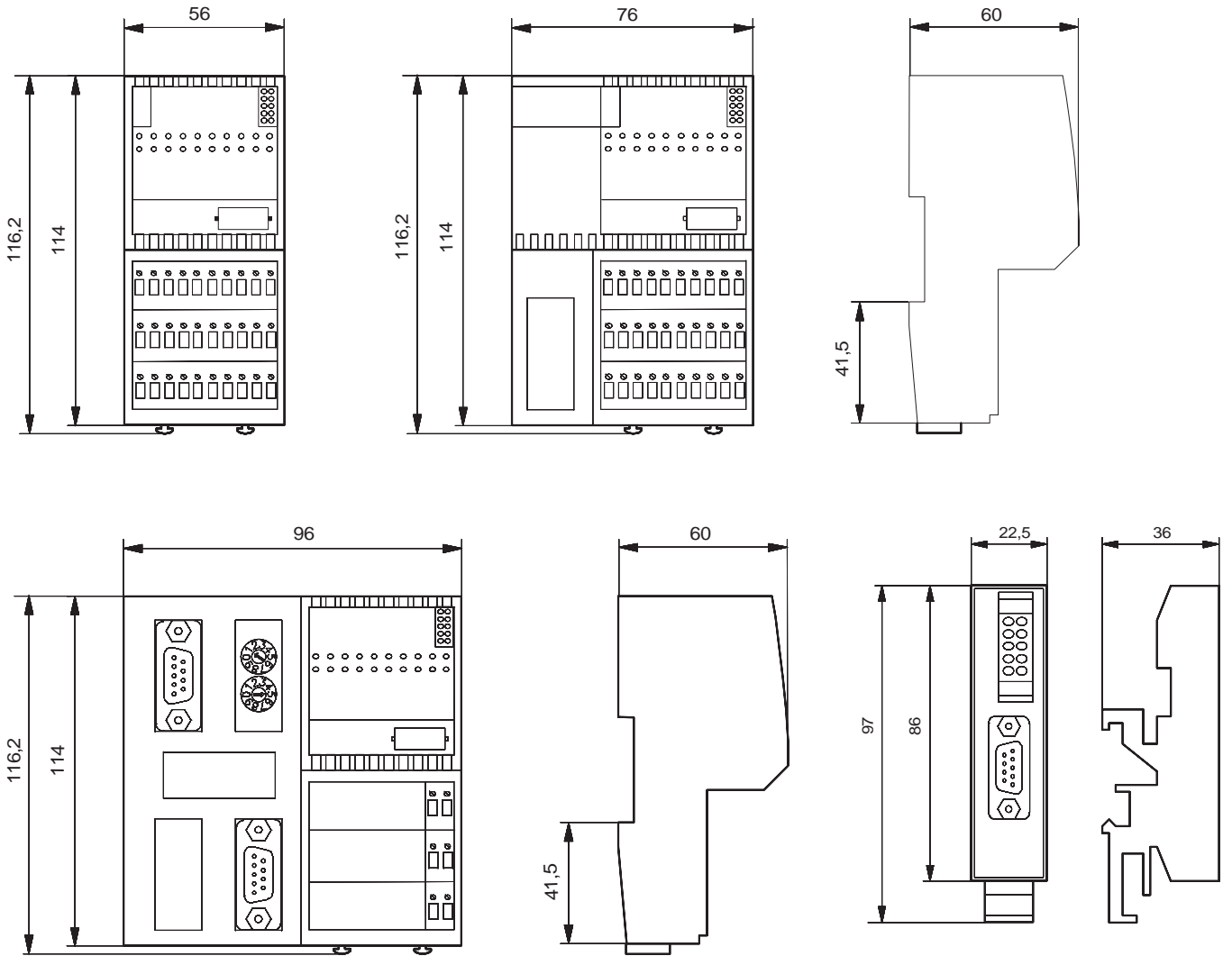

■ Profibus/DP MC Modules

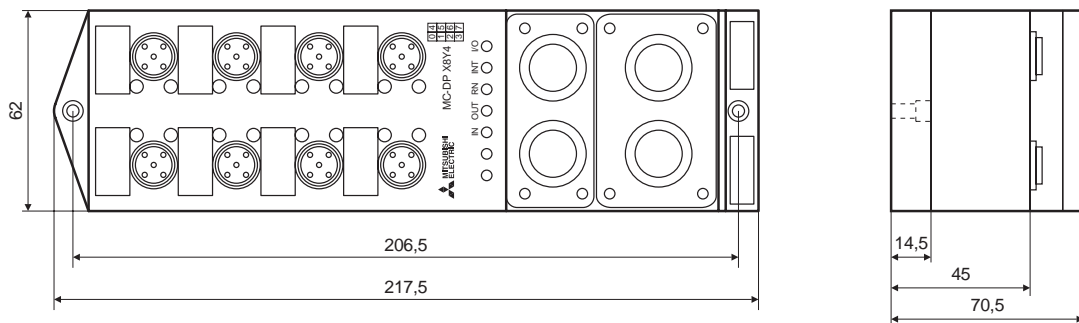

Profibus/DP Compact I/O Modules

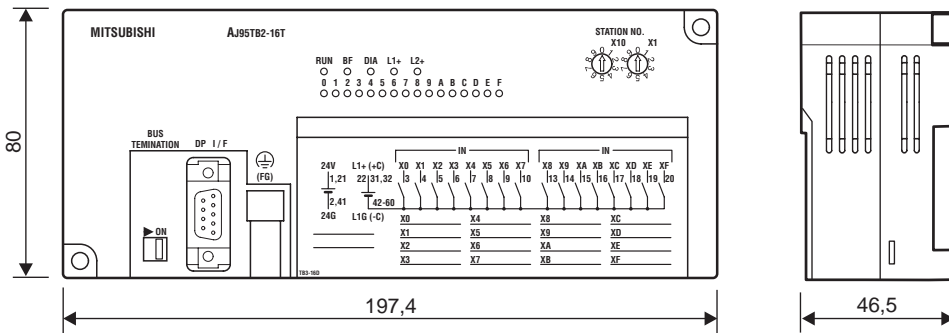

MELSEC AnS/QnAS Decentralised Input/Output Modules

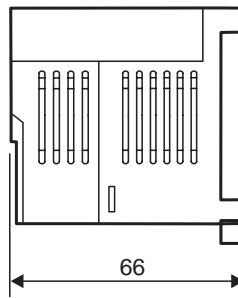
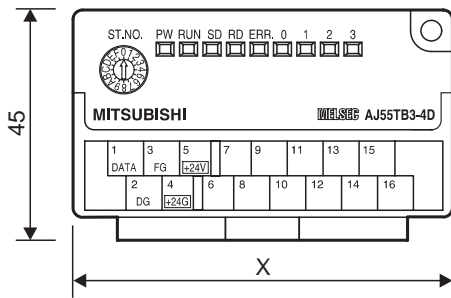

Type	X (in mm)
AJ55TB3-4D	82
AJ55TB3-8D	114
AJ55TB3-16D	177
AJ55TB32-4DR	82
AJ55TB32-8DR	114
AJ55TB32-16DR	177
AJ55TB2-4R	82
AJ55TB2-8R	114
AJ55TB2-16R	177

CC-Link Decentralised Input/Output Modules and Special Function Modules

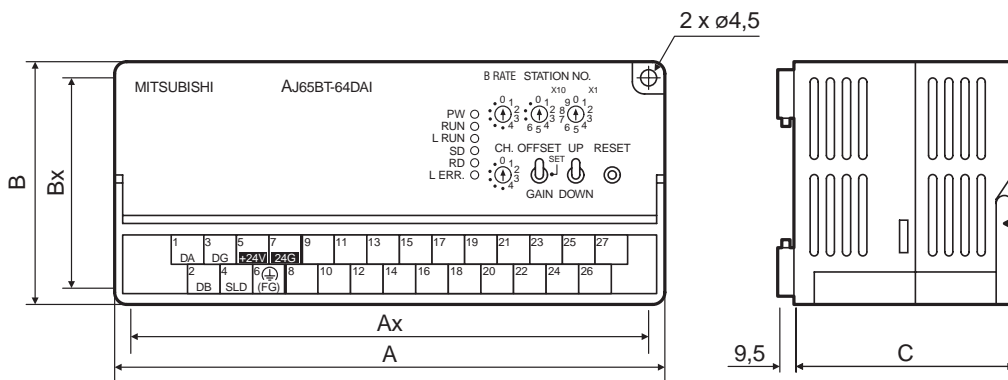

Type	I/O Modules						Analog modules				Special Funktion Modules			
	AJ65BTB1-16D	AJ65BTB2-16D	AJ65BTC1-32D	AJ65BTB1-16DT	AJ65BTB1-16T	AJ65BTC1-32T	AJ65BTB2-16R	AJ65BT-64AD	AJ65BT-64DAV/DAI	AJ65BT-68TD	AJ65BT-64RD3/4	AJ65BT-D62	AJ65BT-D75P2-S3	AJ65BT-R2
A	151.9	197.4	165	151.9	151.9	165	197.4	151.9	151.9	151.9	151.9	151.9	170	170
Ax	142.9	188.4	156	142.9	142.9	156	188.4	142.9	142.9	142.9	142.9	142.9	161	161
B	65	65	65	65	65	65	65	65	65	65	65	65	80	80
Bx	56	56	56	56	56	56	56	56	56	56	56	56	71	71
C	46	46	46	46	46	46	46	63	63	63	63	63	63.5	63.5

Programming and Documentation Software for Standard Personal Computers

With the MELSoft software family Mitsubishi Electric offers efficient software packages helping to reduce programming and setup times to a high degree. The MELSoft software family provides instant access, direct communications, compatibility, and open exchange of variables.

- The MELSoft family comprises:
- Programming packages like GPP/WIN and MELSEC MEDOC *plus*
 - Network configuration software MELSEC ProfiMap
 - Visualization software MX SCADA
 - Software for a dynamic data exchange like MXChange
 - Various development software for operator terminals (refer to the Technical Catalogue HMI)

GPP/WIN is recommended as a cost-effective beginners package for the A/Q series. This package offers a quick and easy introduction to programming. For structured programming the IEC1131 conform programming software MELSEC MEDOC *plus* is recommended. For detailed information please order our separate MELSoft brochure.

■ GPP/WIN

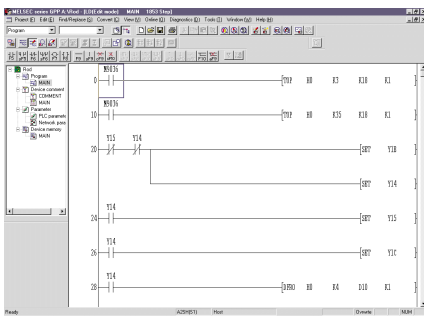

GPP/WIN is the standard programming software for the MELSEC A/Q series and combines all functions of MELSEC MEDOC with the user guidance of Microsoft Windows.

With GPP/WIN you can comfortably create PLC programs alternatively in the form of Ladder Diagrams or Instruction Lists. Both forms of representation can be toggled easily during operation.

Besides efficient monitoring and diagnostics functions GPP/WIN features an offline simulation of any PLC type from the FX0S to the Q4AR.

This software provides all the Windows-specific advantages and is especially suited to all MELSEC PLCs.

GPP/WIN can be run under Windows 95 and Windows NT.

Software	MM GPP/WIN	
Series	All MELSEC PLCs	All MELSEC PLCs
Language	English / German	English / German
Disk type	CD ROM	CD ROM
Included accessory	Converter	—
Order information	Art. no.	
	126047	126048

■ MELSEC MEDOC *plus*

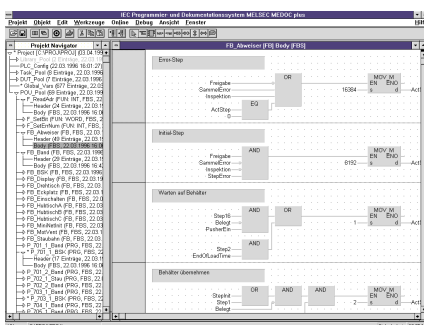

MELSEC MEDOC *plus* provides all functions of the pre-mentioned programs and meets the programming standard for the future: IEC 1131.3. This makes MELSEC MEDOC *plus* ready for the programming standard of the future and offers in addition the basis for the on-leading programming of the MELSEC A and Q series.

MELSEC MEDOC *plus* can be run under Windows 3.11 and Windows 95/98.

The software is supplied complete with an SC-09N serial interface cable.

Software	S-Set	Q-Set
Series	AnS(H), AnAS, AnUS, FX family	All MELSEC PLCs
Language	English / German	English / German
Disk type	CD ROM	CD ROM
Order information	Art. no.	
	126810	126811

Network Configurations Software, Visualization Software and Software for Dynamic Data Exchange

MELSEC ProfiMap

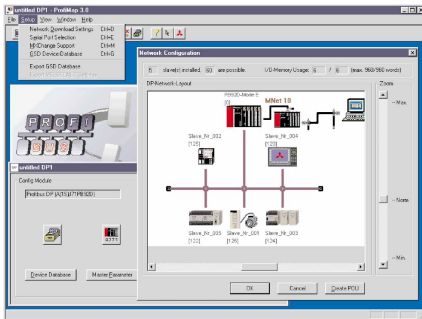

MELSEC ProfiMap V3.0 is a user friendly configurations software for open networks like MAP 3.0/ETHERNET and PROFIBUS/DP or PROFIBUS/FMS.

The software package is a 32 bit application for Windows 95 and Windows NT4.0. Configuration of all PROFIBUS modules for the MELSEC AnS/QnAS and A/Q series is possible.

Due to the supported extended user parameters of a GSD file, easy parameter setting of PROFIBUS/DP slave devices is possible even for third party devices.

The new ProfiMap V3.0 enables the download of all configuration data via an overriding network.

Software	ProfiMap 3.0 CD-Set	ProfiMap 3.0 CD
Supported master modules for the Mitsubishi MELSEC AnS/QnAS and A/Q series	Profibus/DP: A1SJ71PB92D, AJ71PB92D Profibus/FMS: A1SJ71PB96F, AJ71PB96F MAP3.0/Ethernet: AJ71M56EF2	Profibus/DP: A1SJ71PB92D, AJ71PB92D Profibus/FMS: A1SJ71PB96F, AJ71PB96F MAP3.0/Ethernet: AJ71M56EF2
Language	English	English
Configuration cable	ProfiCab is included	ProfiCab is not included
Disk type	CD ROM	CD ROM
Order information	Art. no. 128585	128586

MELSEC MX SCADA

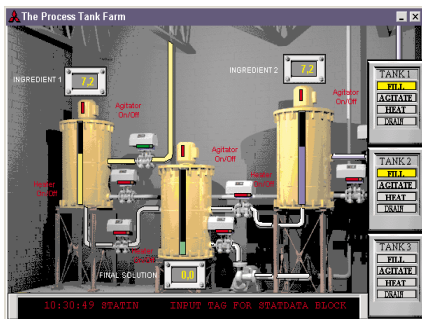

MELSEC MX SCADA is a process visualisation system that can handle everything from simple installations to complex production control systems. The software package can administer up to 100000 objects.

A variety of interfaces are supported, including ETHERNET. The software runs under Windows 95 and Windows NT and is available in a variety of different versions geared to the objects to be handled.

Software	Development version	Run-time version	DEMO version
Series	All MELSEC PLC	All MELSEC PLC	All MELSEC PLC
Language	English	English	English
Disk type	CD ROM	CD ROM	CD ROM
Order information	Art. no. On request	On request	65135

MELSEC MX Change

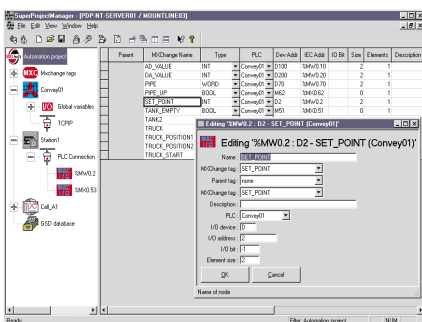

MELSEC MXChange is integrated in the MELSOFT family as the "heart of automation". The software package consists of a Server and a Super Projekt Manager, other automation programs can be connected to. Since MXChange operates across a network, any variable once declared can be used by all other systems connected to the database.

Through this method following the principle "define once and use anywhere" the development time can even be decreased drastically.

The software runs under Windows 95 and Windows NT.

Software	MXChange Network	Stand-alone	Stand-alone
Language	English	English	English
Executable tags	10.000	10.000	500
Disk type	CD ROM	CD ROM	CD ROM
Order information	Art. no. 129639	129640	129641

Graphical Programming for Closed-loop Control Systems

MELSEC IDR BLOK

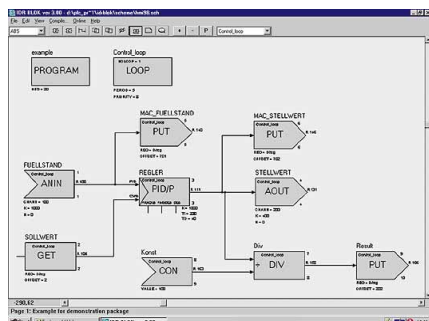

IDR-BLOK is a user-friendly development tool for programming closed-loop applications using PLC technology. Configuring a controlled system couldn't be simpler – you just assemble it graphically by placing function blocks on the screen and the integrated compiler then generates the code for the PLC. The open design means that the user can intervene and change the control parameters at any time with the PLC program.

Additional function blocks for autotuning, fuzzy logic and ATHC are available in combination with the run-time module IDR10F-ADU.

IDR-BLOK turns a sequential logic controller into a multi-loop controller. It is the closed-loop programming software package for all AnSH/QnAS* controllers (*QnAS only in combination with a co-processor module).

The software runs under Windows 95/98 and Windows NT.

Software	Full version	Compact version	Demo version
Application	CPU AnSH (AnN)* mit Co-Prozessor* AnAS, QnAS (AnU, AnA, QnA)*		
Max. used blocks per application	1.024	64	16
Language	English		
Disk type	CD ROM		
Order information	Art. no. 129666	129665	on request

* For the AnN, AnU, AnA and QnA series the following accessories are required: connection cable A1SC05NB (art.no. 24983) and extension base unit A1S52B-51 (art.no. 39667).

RUN-Time Products for IDR BLOK

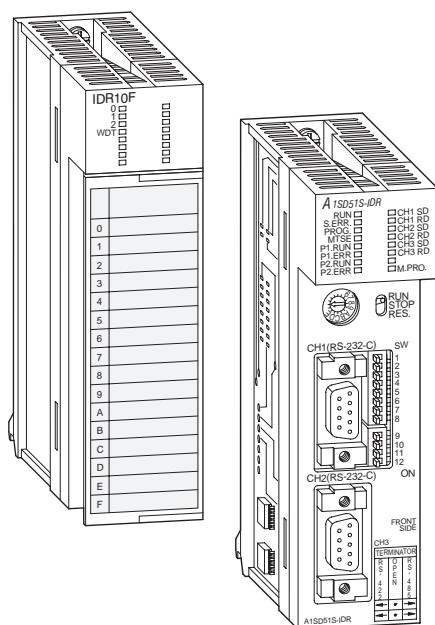

To use the IDR-BLOK software the hereafter described run-time modules are necessary. These modules are available as single modules or within a bundle package.

The IDR function module IDR10F is an integrated necessary part of the run-time package. It provides supervisory functions for the customer with digital output watch dog alarm signals and protects the process control against unexpected troubles.

The A1SD51S-IDR is a co-processor module which is a standard MELSEC high-speed communication module A1SD51S with a preloaded IDR BLOK interpreter.

Specifications	IDR10F-STD	IDR10F-ADV	IDR bundle 1	IDR bundle 2
Shipping contents	1 x IDR10F-STD	1 x IDR10F-ADV	IDR-BLOK software, 1 x IDR10F-STD, 1 x A1SD51S-IDR	IDR-BLOK software, 1 x IDR10F-ADV, 1 x A1SD51S-IDR
Program features	Function blocks Additional functions	Max. 1024 Fuzzy logic, GAT, ATHC	Max. 1024	Max. 1024 Fuzzy logic, GAT, ATHC
Software	—	—	IDR-BLOK 4.10	IDR-BLOK 4.10
Module dimensions	34.5 x 130 x 93.6	34.5 x 130 x 93.6	34.5 x 130 x 93.6	34.5 x 130 x 93.6
Order information	Art. no. 125359	129658	87511	on request

Co-Processor Module SPAC20

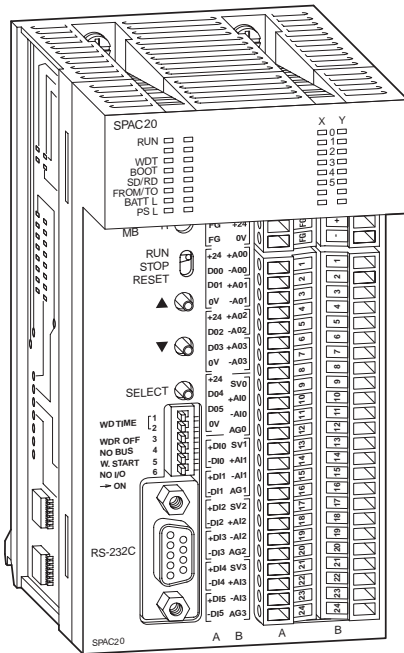

■ Hand-held Programming Unit A7PU

The hand-held programming unit A7PU is used for the MELSEC A controllers.

The programming unit can be mounted directly on the controller or connected by a cable.

Programming takes the form of an instruction list.

The unit is suitable for minor program changes directly on the machine.

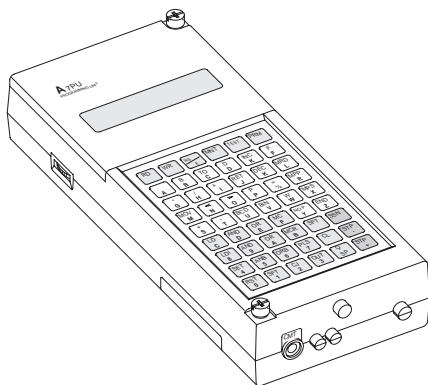

Specifications	A7PU
General specifications	Conform to basic components of AnS/QnAS
Ambient temperature	0 – 40 °C
Ambient relative humidity (non-condensing)	85 %
Power supply	5 V DC (from PLC)
Current consumption	mA 300
Display	LCD
Character display	16 x 2
Keyboard	54 keys
Cable, is adjoined	J1, to connect a standard cassette-player
Weight	kg 0.5
Dimensions (W x H x D)	mm 188 x 79 x 44.5
Order information	Art. no. 3922

■ A6WU EPROM Writer

The EPROM writer A6WU is used for transferring the PLC programs of the MELSEC AnS controller to the EPROM memory cassette. Conversely, existing programs on the

memory cassette can be written into the CMOS RAM of the controller and program comparisons can be carried out.

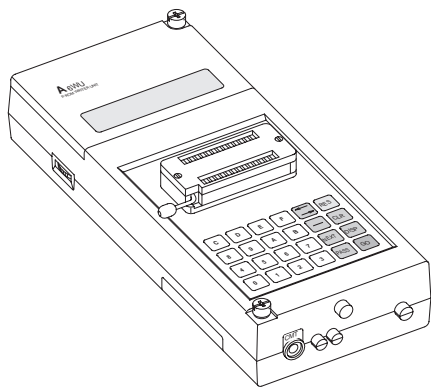

A6WU	
Order information	Art. no. 3921

■ Connecting Cable

The cables AC30R4 and AC300CR4 are used for connecting the hand-held programming unit to the controller.

The cable AC 30WU is used for connecting the EPROM writer.

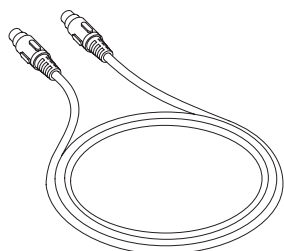

Specifications	AC 30R4	AC300CR4	AC 30WU
Connecting device	A7PU	A7PU	A6WU
Length	m 3	30	3
Order information	Art. no. 3930	3928	15033

■ Teaching Unit AD71TU

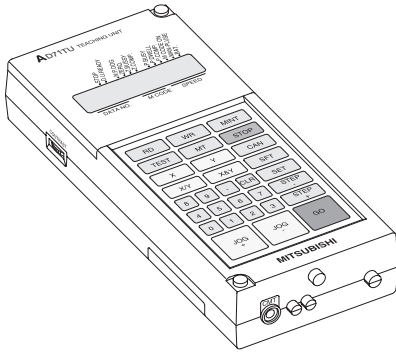

The AD71TU teaching unit is used for setting parameters and entering position data for the AD71 and AD72 positioning modules.

Position parameters are read and written via the handy unit's integrated RS422 interface.

This unit is often used for on-site system setup and commissioning.

An additional interface is provided for the connection of a standard cassette recorder for data storage.

Specifications	AD71TU
General specifications	Conforms to MELSEC A series basic components
Ambient temperature	0 – 40 °C
Storage temperature	-20 °C – 50 °C
Power supply	V DC 5 (by positioning module)
Power consumption	mA 0.3
Display type	LCD
Display format	16 characters x 2 lines
Keypad	Membrane keypad, 30 keys
Cassette recorder cable	J1, for connection of a standard cassette recorder
Programming software	SW0-AD71PE, art. no. 4191
Programming cable	AC30R4, art. no. 3930
Weight	kg 0.45
Dimensions (W x H x D)	mm 79 x 188 x 23
Order information	Art. no. 4193



Accessories

Adapter cable for extension base units	79
Battery A6BAT	81
Connecting cable A32CBL	79
Connecting cable for programming unit	96
Dust cover	81
EPROM-/EEPROM memory cassettes	80
EPROM adapter units	80
EPROM writer A6WU	96
Fuses	81
Hand-held programming unit A7PU	96
Interface converter	79
Memory cards	80
Profibus connector	82
System adapter set for MT series	82
Teaching unit AD71TU	97

Analog input/output modules

A1S62DA	20
A1S62RD3	22
A1S62RD4	22
A1S63ADA	21
A1S64AD	19
A1S64TCRT-S1	24
A1S64TCTT-S1	24
A1S66ADA	21
A1S68AD	19
A1S68DAI	20
A1S68DAV	20
A1S68TD	23

Base and extension units

A1S32B-E	12
A1S33B-E	12
A1S35B-E	12
A1S38B-E	12
A1S52B-S1	12
A1S55B-S1	12
A1S58B-S1	12
A1S38HB	12
A1S65B-S1	12
A1S68B-S1	12

Communications modules

A1SJ51T64	66
A1SJ61BT11	49
A1SJ61QBT11	49
A1SJ71AP21	44
A1SJ71AR21	44
A1SJ71AS92	75
A1SJ71AT21B	47
A1SJ71BR11	39
A1SJ71DN91	73
A1SJ71E71-B2-S3	36
A1SJ71E71-B5-S3	36
A1SJ71LP21	39
A1SJ71LP21GE	39
A1SJ71PB92D	65
A1SJ71PB96F	65
A1SJ71QBR11	40
A1SJ71QE71-B2	37
A1SJ71QE71-B5	37
A1SJ71QLP21	40
A1SJ71QLP25	41
A1SJ71QLR21	40
A1SJ72QBR15	41
A1SJ72T25B	47
A7BDE-J71AP21	45
A7BDE-J71AR21	45
A70BDE-J71QBR13	42
A70BDE-J71QLP23	42
A70BDE-J71QLP23GE	42
A70BDE-J71QLR23	42

A80BD(E)-J61BT13	59
AJ55TB2-16R	63
AJ55TB2-4R	63
AJ55TB2-8R	63
AJ55TB3-16D	62
AJ55TB32-16DR	62
AJ55TB32-4DR	62
AJ55TB32-8DR	62
AJ55TB3-4D	62
AJ55TB3-8D	62
AJ65BT-62D	55
AJ65BT-62D-S1	55
AJ65BT-64AD	52
AJ65BT-64DAI	53
AJ65BT-64DAV	53
AJ65BT-64RD3	54
AJ65BT-64RD4	54
AJ65BT-68TD	56
AJ65BTB1-16D	50
AJ65BTB1-16DT	50
AJ65BTB1-16T	51
AJ65BTB2-16D	50
AJ65BTB2-16R	51
AJ65BTC1-32D	50
AJ65BTC1-32T	51
AJ65BT-D62	55
AJ65BT-D75P2-S3	57
AJ65BT-R2	58
AJ95TB2-16T	66
AJ95TB3-16D	66
AJ95TB32-16DT	66
MC-DPX16	71
MC-DPX8	71
MC-DPX8Y4	71
MC-DPY8	71
MT-4AD	70
MT-4DA	70
MT-4DAV	70
MT-DP12	67
MT-DP12E	67
MT-X16	68
MT-X4Y4T	68
MT-X8	68
MT-Y16T	69
MT-Y4R	69
MT-Y8R5	69
MT-Y8T	69
MT-Y8T2	69

Counter modules

A1SD61	26
A1SD62E	26

CPU modules

A1SHCPU	14
A2SHCPU	14
A2SHCPU-S1	14
A2ASCPU	15
A2ASCPU-S1	15
A2ASCPU-S30	15
A2ASCPU-S60	15
A80BDE-A2USH-S1	17
Q2ASCPU	16
Q2ASCPU-S1	16
Q2ASHCPU	16
Q2ASHCPU-S1	16

Digital input/output modules

A1SX10EU	18
A1SX20EU	18
A1SX80	18
A1SX80-S1	18

A1SX81	18
A1SY10EU	19
A1SY14EU	19
A1SY18AEU	19
A1SY22	19
A1SY28EU	19
A1SY68A	19
A1SY80	19
A1SY81	19

Dummy modules

A1SG60	78
A1SG62	78

Interface modules

A1SD51S(-BAL)	33
A1SJ71C24-PRF	30
A1SJ71QC24-R2	32
A1SJ71QC24	32
A1SJ71UC24-R2	30
A1SJ71UC24-R4	30
A1SJ71UC24-R2-S2	31
A1SJ71UC24-R4-S2	31

Network descriptions

ASI-Interface	75
CC-Link	48
DeviceNet	72
ETHERNET	35
MELSECNET/B	46
MELSECNET/10	38
MELSECNET (II)	43
MELSEC I/O-Link	60
PROFIBUS/DP	64

Positioning modules

A1SD70	29
A1SD71-S2	28
A1SD75P1-S3	28
A1SD75P2-S3	28
A1SD75P3-S3	28

Pulse catch and interrupt modules

A1SP60	76
A1SI61	77

Power supply modules

A1S61PN	13
A1S62PN	13
A1S63P	13

Software

MELSEC IDR BLOK	94
MELSEC MEDOC GPP/WIN	92
MELSEC MEDOC <i>plus</i>	92
MELSEC MX Change	93
MELSEC MX SCADA	94
MELSEC ProfiMap	94

Timer module

A1ST60	27
--------	----

HEADQUARTERS

MITSUBISHI ELECTRIC EUROPE B.V. EUROPE
German Branch
Gothaer Straße 8
D-40880 Ratingen
Phone: +49 (0) 21 02 / 486-0
Fax: +49 (0) 21 02 / 4 86-1 12
E mail: megfamail@meg.mee.com

MITSUBISHI ELECTRIC EUROPE B.V. ITALY
ITALIAN BRANCH
Via Parcelso 12
I-20041 Agrate Brianza (MI)
Phone: +39 039 6053 1
Fax: +39 039 6053 312
E mail: industrial@it.mee.com

MITSUBISHI ELECTRIC EUROPE B.V. SPAIN
SPANISH BRANCH
Calle Joan Buscallá, 2-4
E-08190 Sant Cugat del Vallés
Phone: +34 (9) 3 / 565 31 60
Fax: +34 (9) 3 / 589 15 79
E mail: industrial@sp.mee.com

MITSUBISHI ELECTRIC EUROPE B.V. UK
UK Branch
Travellers Lane
GB-Hatfield Herts. AL10 8 XB
Phone: +44 (0) 1707 / 27 61 00
Fax: +44 (0) 1707 / 27 86 95

MITSUBISHI ELECTRIC CORPORATION JAPAN
Mitsubishi Denki Bldg.
2-2-3 Marunouchi
Tokyo 100-8310
Phone: +81 (0) 3 / 32 18 31 76
Fax: +81 (0) 3 / 32 18 24 22

MITSUBISHI ELECTRIC AUTOMATION USA
500 Corporate Woods Parkway
Vernon Hills, IL 60061
Phone: +1 847 / 478 21 00
Fax: +1 847 / 478 22 83

EUROPAN REPRESENTATIVES

GEVA GmbH AUSTRIA
Wiener Straße 89
A-2500 Baden
Phone: +43 (0) 2252 / 85 55 20
Fax: +43 (0) 2252 / 488 60
E mail: office@geva.co.at

GETRONICS NV/SA BELGIUM
Pontbeeklaan 43
B-1731 Zellik
Phone: +32 (0) 2 / 467 17 51
Fax: +32 (0) 2 / 467 17 45

INEA CR d.o.o. CROATIA
Drvinje bb
HR-10000 Zagreb
Phone: +385 (0) 1 / 366 71 40
Fax: +385 (0) 1 / 366 71 40

AUTOCONT s.r.o. CZECHIA
Nemocnicni 12
CZ-70100 Ostrava 1
Phone: +420 (0) 69 / 615 21 11
Fax: +420 (0) 69 / 615 21 12

Louis Poulsen DENMARK
Geminivej 32
DK-2670 Greve
Phone: +45 (0) 43 / 95 95 95
Fax: +45 (0) 43 / 95 95 90
E mail: elpefa@elpefa.dk

UTU ELEKTROTEHNIKA AS ESTONIA
P.O. Box 4180
EE-0090 Tallinn
Phone: +372 6 / 56 31 94
Fax: +372 6 / 56 38 36
E mail: utu@uninet.ee

Beijer Electronics OY FINLAND
Elannontie 5
FIN-01510 Vantaa
Phone: +358 (0) 9 / 615 20 11
Fax: +358 (0) 9 / 615 20 500
E mail: info@elc.beijer.fi

IP Systèmes FRANCE
8, Rue Du Colonel Chambonnet
F-69672 Lyon Bron Cedex
Phone: +33 (0) 4 / 72 14 18 00
Fax: +33 (0) 4 / 72 14 18 01
E mail: info@ip-systemes.fr

SANDSOFT HUNGARY
5 Rőppentyü Köz
H-1139 Budapest
Phone: +36 (0) 1 / 375 38 98
Fax: +36 (0) 1 / 3 75 06 88

MITSUBISHI ELECTRIC EUROPE B.V. IRELAND
Westgate Business Park, Ballymount
IRL-Dublin 24
Phone: +353 (0) 1 / 419 88 00
Fax: +353 (0) 1 / 419 88 90

CARPANETO & C. S.p.A. ITALY
Via Ferrero 10
I-10090 Cascine Vica-Rivoli (TO)
Phone: +39 011 / 959 01 11
Fax: +39 011 / 959 02 50
E mail: info.carpaneto@carpaneto.it

EUROPAN REPRESENTATIVES

Getronics bv NETHERLANDS
Industrial Automation
Donauweg 10
NL-1043 AJ-Amsterdam
Phone: +31 (0) 20 / 586 15 92
Fax: +31 (0) 20 / 586 19 27
E mail: info.algemeen@getronics.nl

Beijer Electronics AS NORWAY
Teglverksveien 1
N-3002 Drammen
Phone: +47 (0) 32 / 24 30 00
Fax: +47 (0) 32 / 84 85 77
E mail: info@elc.beijer.no

MPL Technology Sp. z.o.o POLAND
ul. Wroclawska 53
PL-30011 Kraków
Phone: +48 (0) 12 / 632 28 85
Fax: +48 (0) 12 / 632 47 82
E mail: mpl@krakow.ipl.net

F. Fonseca Lda PORTUGAL
Estrada de Taboreira 87/89, Esgueira
P-3800 Aveiro
Phone: +351 (0) 34 / 31 58 00
Fax: +351 (0) 34 / 31 58 04
E mail: amartins@ffonseca.com

TUINGDOR ROMANIA
20, Fierarilor Street
RO-72126 Bucuresti
Phone: +40 (0) 1 / 211 98 01
Fax: +40 (0) 1 / 210 71 81
E mail: tuingdor@pcnet.ro

INEA d.o.o. SLOVENIA
Ljubljanska 80
SI-1230 Domžale
Phone: +386 (0) 1 / 721 80 00
Fax: +386 (0) 1 / 724 16 72
E mail: zoran.marinsek@inea.si

Medición y Control, S.A. SPAIN
Gr. Via d. l. Corts Catalanes 133, 4
E-08014 Barcelona
Phone: +34 (9) 3 / 422 77 00
Fax: +34 (9) 3 / 432 28 47
E mail: admin@mecco.org

Beijer Electronics AB SWEDEN
Box 325
S-20123 Malmö
Phone: +46 (0) 40 / 35 86 00
Fax: +46 (0) 40 / 93 23 01
E mail: info@elc.beijer.se

ECONOTEC AG SWITZERLAND
Postfach 282
CH-8309 Nürensdorf
Phone: +41 (0) 1 / 838 48 11
Fax: +41 (0) 1 / 838 48 12
E mail: info@econotec.ch

GTS TURKEY
Fahri Gizden Sokak,
Hacaloglu Apt. No. 22/6
TR-80280 Gayrettepe/Istanbul
Phone: +90 (0) 212 / 267 40 11
Fax: +90 (0) 212 / 266 14 50
E mail: gts@turk.net

MIDDLE EAST REPRESENTATIVES

TEXEL Electronics Ltd. ISRAEL
PO Box 6272
IL-Netanya 42160
Phone: +972 (0) 9 / 863 08 94
Fax: +972 (0) 9 / 885 24 30
E mail: texel_me@netvsnion.net.il

EURASIAN REPRESENTATIVE

JV-CSC Automation UKRAINE
Borisoglebskya St. 11
U-254070 Kiev
Phone: +380 (4) 4 / 416 42 02
Fax: +380 (4) 4 / 463 63 93
E mail: csc-a@carrier.ki

