

Scanning Range

0.01 to 5 m



Features:

- Polarizing filter, enabling objects even with reflecting surfaces to be detected
- Light- or dark-switching, switch-selectable
- Adjustable sensitivity (DC)
- Blinking LED status indicator to show misalignment
- Switch-selectable time delays (AC)
- Output to signal dirt build-up on optics (DC)
- Two-position cable entry gland (90° apart)
- Glassfiber-reinforced plastic housing
- Transistor outputs, overload and short circuit protected
- Test input to test sensor on demand from remote location (DC)
- CE / UL / SP

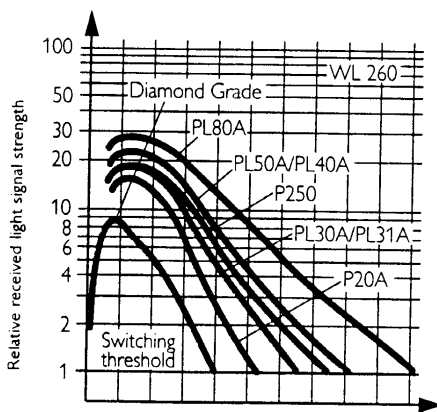

WL 260

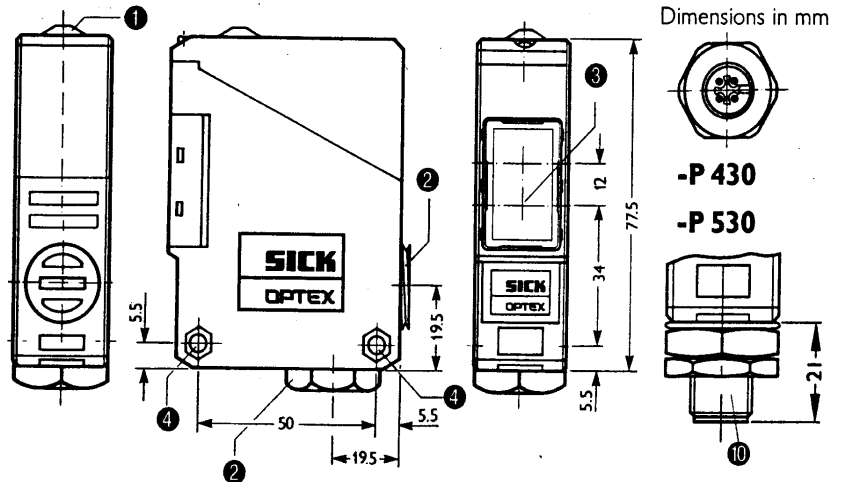

Dimensions in mm

-P 430

-P 530

-S/-R 230

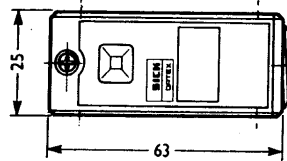

-P 230

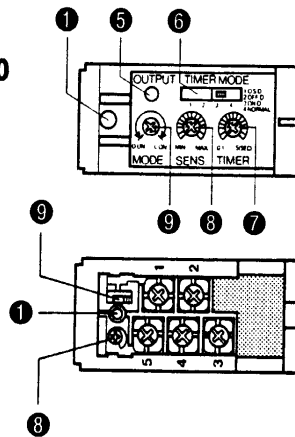

- 1 Status indicator
- 2 Cable entry gland, 1/2" PF thread, for cable diameters from 6 to 10 mm
- 3 Centre of optical axis
- 4 Mounting holes through enclosure, recessed on both sides for M5 hex nut
- 5 LED output indicator (WL 260-R)
- 6 Time-delay selector switch (WL 260-R)
1 ONE SHOT
2 OFF-delay
3 ON-delay
4 No time delay (NORMAL)
- 7 Time-delay control 0.1 to 5 s (WL 260-R)
- 8 Sensitivity control
- 9 Mode selector (light-/dark-switching)
- 10 M 12 plug, 4-pin or 5-pin

For reflector P 250 (included), see page 280

For mounting bracket (included), see page 282

(For cable receptacles, see Accessories, page 286)

Connection Diagram

WL 260

-S/-R 230

-P 230

-P 430

-P 530

P

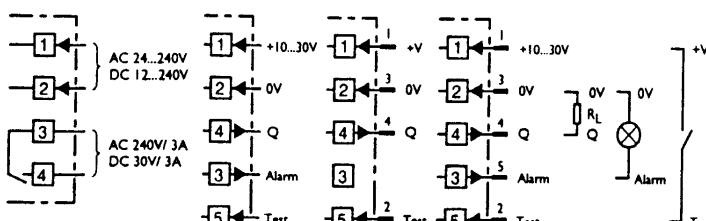

WL 260 Photoelectric Reflex Switch

	WL 260	-S 230	-R 230	-P 230 ⁹⁾
Part No.		6008773	6008772	6008952
Type of connection	terminal chamber			
Scanning range SR with reflector P 250	0.01 to 5 m			
Light spot diameter ¹⁾	150 mm			
Supply voltage V_S	12 to 240 VDC ²⁾ 24 to 240 VAC ²⁾			10 to 30 VDC ⁸⁾
Current/power consumption (no load)	≤ 2 VA			≤ 35 mA
Ripple max. ³⁾	-			5 V _{pp}
Light source	LED, visible red light, modulated, average service life 100,000 h ⁴⁾			
Light receiver switching mode	light-/dark-switching, switch-selectable			
Switching output	relay, 1 x NO, electrically isolated			PNP open collect.
Signal voltage HIGH	-			V _S - (≤ 1V)
Signal voltage LOW	-			approx. 0V
Output current max.	3 A/240 VAC; 3 A/30 VDC			100 mA (200 mA) ⁵⁾
Alarm output (static)	-			100 mA (200 mA) ⁵⁾
Test input T ₁	-			light source disconnected
Response time; switching frequency max.	20 ms; 25/s			1 ms; 500/s
Time delay with LED output indicator	-	switch-selectable		-
Switch position	-	OFF-delay, ON-delay, ONE SHOT, no delay (NORMAL)		-
Delay adjustable from	-	0.1 to 5 s		-
VDE protection class⁶⁾	□			
Enclosure rating	IP 66			
Circuit protection ⁷⁾	A, C			A, B, C
Ambient operating temperature	- 25 to + 55 °C			
Storage temperature	- 40 to + 70 °C			
Weight	approx. 120 g			





1) With scanning range SR
2) ± 10 %
3) Must be within V_S tolerances
4) At room temperature = + 25 °C

5) Maximum current from switching output and alarm output 200 mA
6) Withstand voltage 50 VDC; 250 VAC

7) A = supply connections reverse-polarity protected
B = output Q overcurrent and short circuit protected
C = interference suppression

8) Limit values
9) For plugs see Selection Table

Truth Table

Timer mode	Light beam	Uninterrupted	
		Interrupted	Interrupted
No time delay  1 2 3 4	○		ON
	●		OFF
ONE SHOT*  1 2 3 4	○		ON
	●		OFF
OFF-delay*  1 2 3 4	○		ON
	●		OFF
ON-delay*  1 2 3 4	○		ON
	●		OFF

Selection Table

Plug	Photoelectric Reflex Switch	Part No.
M 12, 4-pin	WL 260 -P 430	1012 079
M 12, 5-pin	WL 260 -P 530	1011 690

* Timers only for - R 230
○ light-switching
● dark-switching
T = 0.1 to 5 s