

## HIGH-VOLTAGE, HIGH-CURRENT DARLINGTON ARRAYS

### ULS20XXH/R

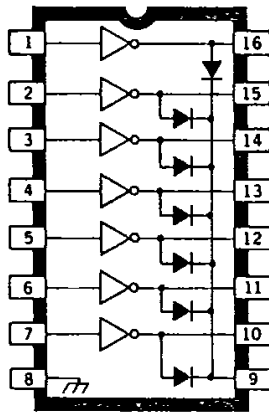

Dwg. No. A-9594

### ABSOLUTE MAXIMUM RATINGS

Output Voltage, $V_{CE}$	
(ULS200X*, ULS201X*) .....	50 V
(ULS202X*) .....	95 V
Input Voltage, $V_{IN}$	
(ULS20X2*, X3*, X4*) .....	30 V
(ULS20X5*) .....	15 V
Peak Output Current, $I_{OUT}$	
(ULS200X*, ULS202X*) .....	500 mA
(ULS201X*) .....	600 mA
Ground Terminal Current, $I_{GND}$ .....	3.0 A
Continuous Input Current, $I_{IN}$ .....	25 mA
Power Dissipation, $P_D$	
(one Darlington pair) .....	1.0 W
(total package) .....	See Graph
Operating Temperature Range,	
$T_A$ .....	-55°C to +125°C
Storage Temperature Range,	
$T_S$ .....	-65°C to +150°C

X = digit to identify specific device. Characteristic shown applies to family of devices with remaining digits as shown.

\*Complete part number includes a final letter to indicate package.

Comprised of seven silicon NPN Darlington power drivers on a common monolithic substrate, Series ULS2000EK, ULS2000H, and ULS2000R arrays drive relays, solenoids, magnetic print hammers, lamps, and other devices in high-reliability military or aerospace applications with up to 3 A of output current per package.

These devices are screened to MIL-STD-883, Class B and are supplied in a leadless ceramic chip carrier with Kovar lid (suffix 'EK'), the popular ceramic/metal side-brazed 16-pin hermetic package (suffix 'H'), or ceramic/glass cer-DIP hermetic package (suffix 'R'). All package styles conform to the dimensional requirements of MIL-M-38510 and are rated for operation over the full military temperature range of -55°C to +125°C. Reverse-bias burn-in and 100% high-reliability screening are standard.

The 35 integrated circuits described here permit the circuit designer to select the optimal device for any application. In addition to the three package styles (note that the ceramic chip carrier is available only for the ULS2001EK through ULS2005EK devices), there are five input characteristics, two output-voltage ratings, and two output-current ratings. The appropriate part for specific applications can be determined from the Device Part Number Designation chart. All units have open-collector outputs and on-chip diodes for inductive-load transient suppression.

### FEATURES

- TTL, DTL, PMOS, or CMOS Compatible Inputs
- Peak Output Current to 600 mA
- Transient-Protected Outputs
- High-Reliability Screening to MIL-STD-883, Class B
- -55°C to +125°C Temperature Range

### ULS200XEK

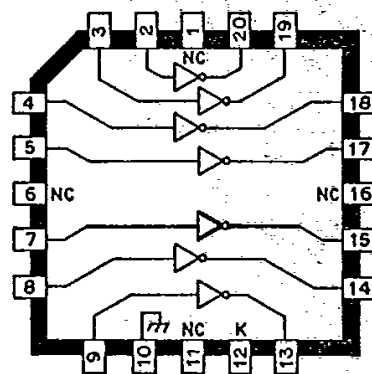

Dwg. No. A-14,378

Always order by complete part number, e.g., **ULS2013H883**.  
See matrix on next page.

# 2001 THRU 2025 HIGH VOLTAGE, HIGH-CURRENT DARLINGTON ARRAYS

T-43-25

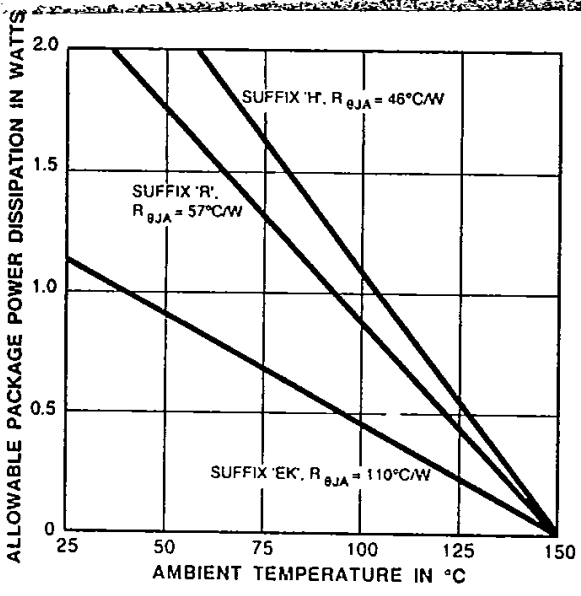

Dwg. GM-004

## DEVICE PART NUMBER DESIGNATION

$V_{CE(MAX)}$	50 V	50 V	95 V
$I_{C(MAX)}$	500 mA	600 mA	500 mA
Logic	Part Number		
General Purpose PMOS, CMOS	ULS2001*	ULS2011*	ULS2021*
14-25 V PMOS	ULS2002*	ULS2012*	ULS2022*
5 V TTL, CMOS	ULS2003*	ULS2013*	ULS2023*
6-15 V CMOS, PMOS	ULS2004*	ULS2014*	ULS2024*
High-Output TTL	ULS2005*	ULS2015*	ULS2025*

## PARTIAL SCHEMATICS

**ULS20X1°**  
(Each Driver)

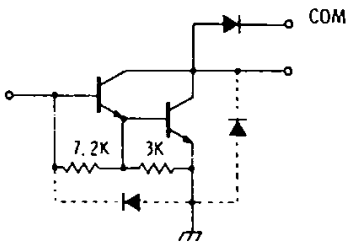

Dwg. No A-9595

**ULS20X2°**  
(Each Driver)

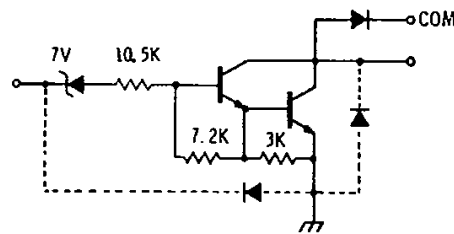

Dwg. No A-9650

**ULS20X3°**  
(Each Driver)

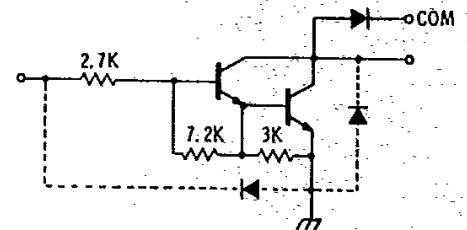

Dwg. No. A-9651

**ULS20X4°**  
(Each Driver)

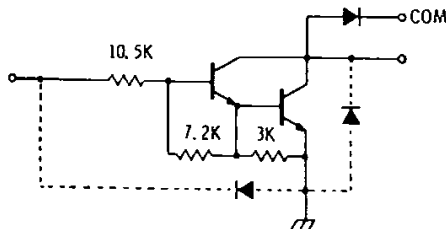

Dwg. No. A-9898A

**ULS20X5°**  
(Each Driver)

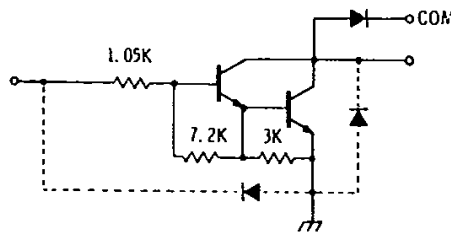

Dwg. No. A-10,228

\* Complete part number includes a final letter to indicate package (EK = leadless ceramic chip carrier, H = ceramic/metal side-brazed, R = ceramic/glass cer-DIP).

X = digit to identify specific device. Specification or limit shown applies to family of devices with remaining digits as shown.

# 2001 THRU 2025 HIGH VOLTAGE, HIGH CURRENT DARLINGTON ARRAYS

T-43-25

## ULS2001EK/H/R THRU ULS2005EK/H/R ELECTRICAL CHARACTERISTICS over operating temperature range (unless otherwise noted)

Characteristic	Symbol	Applicable Devices	Test Conditions			Limits			
			Temp.	Voltage/Current	Fig.	Min.	Typ.	Max.	Units
Output Leakage Current	$I_{CEX}$	All		$V_{CE} = 50\text{ V}$	1A	—	—	100	$\mu\text{A}$
		ULS2002*		$V_{CE} = 50\text{ V}, V_{IN} = 6\text{ V}$	1B	—	—	500	$\mu\text{A}$
		ULS2004*		$V_{CE} = 50\text{ V}, V_{IN} = 1\text{ V}$	1B	—	—	500	$\mu\text{A}$
Collector-Emitter Saturation Voltage	$V_{CE(SAT)}$	All	-55°C	$I_C = 350\text{ mA}, I_B = 850\text{ }\mu\text{A}$	2	—	1.6	1.8	V
				$I_C = 200\text{ mA}, I_B = 550\text{ }\mu\text{A}$	2	—	1.3	1.5	V
				$I_C = 100\text{ mA}, I_B = 350\text{ }\mu\text{A}$	2	—	1.1	1.3	V
			+25°C	$I_C = 350\text{ mA}, I_B = 500\text{ }\mu\text{A}$	2	—	1.25	1.6	V
				$I_C = 200\text{ mA}, I_B = 350\text{ }\mu\text{A}$	2	—	1.1	1.3	V
				$I_C = 100\text{ mA}, I_B = 250\text{ }\mu\text{A}$	2	—	0.9	1.1	V
			+125°C	$I_C = 350\text{ mA}^\dagger, I_B = 500\text{ }\mu\text{A}$	2	—	1.6	1.8	V
				$I_C = 200\text{ mA}^\dagger, I_B = 350\text{ }\mu\text{A}$	2	—	1.3	1.5	V
				$I_C = 100\text{ mA}, I_B = 250\text{ }\mu\text{A}$	2	—	1.1	1.3	V
Input Current	$I_{IN(ON)}$	ULS2002*		$V_{IN} = 17\text{ V}$	3	480	850	1300	$\mu\text{A}$
		ULS2003*		$V_{IN} = 3.85\text{ V}$	3	650	930	1350	$\mu\text{A}$
		ULS2004*		$V_{IN} = 5.0\text{ V}$	3	240	350	500	$\mu\text{A}$
				$V_{IN} = 12\text{ V}$	3	650	1000	1450	$\mu\text{A}$
		ULS2005*		$V_{IN} = 3.0\text{ V}$	3	—	1500	2400	$\mu\text{A}$
	$I_{IN(OFF)}$	All	+125°C	$I_C = 500\text{ }\mu\text{A}$	4	25	50	—	$\mu\text{A}$
Input Voltage	$V_{IN(ON)}$	ULS2002*	-55°C	$V_{CE} = 2.0\text{ V}, I_C = 300\text{ mA}$	5	—	—	18	V
			+125°C	$V_{CE} = 2.0\text{ V}, I_C = 300\text{ mA}^\dagger$	5	—	—	13	V
		ULS2003*	-55°C	$V_{CE} = 2.0\text{ V}, I_C = 200\text{ mA}$	5	—	—	3.3	V
				$V_{CE} = 2.0\text{ V}, I_C = 250\text{ mA}$	5	—	—	3.6	V
				$V_{CE} = 2.0\text{ V}, I_C = 300\text{ mA}$	5	—	—	3.9	V
				$V_{CE} = 2.0\text{ V}, I_C = 300\text{ mA}$	5	—	—	3.9	V
		+125°C	$V_{CE} = 2.0\text{ V}, I_C = 200\text{ mA}^\dagger$	5	—	—	2.4	V	
			$V_{CE} = 2.0\text{ V}, I_C = 250\text{ mA}^\dagger$	5	—	—	2.7	V	
$V_{CE} = 2.0\text{ V}, I_C = 300\text{ mA}^\dagger$	5		—	—	3.0	V			

\*Complete part number includes a final letter to indicate package  
(EK = leadless/ceramic chip carrier, H = ceramic/metal side-brazed, R = ceramic/glass cer-DIP).

Continued next page...

NOTE 1: All limits stated apply to the complete Darlington series except as specified for a single device type.

NOTE 2: The  $I_{IN(OFF)}$  current limit guarantees against partial turn-on of the output.

NOTE 3: The  $V_{IN(ON)}$  voltage limit guarantees a minimum output sink current per the specified test conditions.

$^\dagger$ Pulse Test,  $t_p \leq 1\text{ }\mu\text{s}$ , see graph.

# 2001 THRU 2025 HIGH VOLTAGE, HIGH-CURRENT DARLINGTON ARRAYS

T-43-25

## ULS2001EK/H/R THRU ULS2005EK/H/R ELECTRICAL CHARACTERISTICS continued

Characteristic	Symbol	Applicable Devices	Test Conditions			Limits			
			Temp.	Voltage/Current	Fig.	Min.	Typ.	Max.	Units
Input Voltage (cont.)	$V_{IN(ON)}$	ULS2004*	-55°C	$V_{CE} = 2.0\text{ V}, I_C = 125\text{ mA}$	5	—	—	6.0	V
				$V_{CE} = 2.0\text{ V}, I_C = 200\text{ mA}$	5	—	—	8.0	V
				$V_{CE} = 2.0\text{ V}, I_C = 275\text{ mA}$	5	—	—	10	V
				$V_{CE} = 2.0\text{ V}, I_C = 350\text{ mA}$	5	—	—	12	V
		+125°C	$V_{CE} = 2.0\text{ V}, I_C = 125\text{ mA}$	5	—	—	5.0	V	
			$V_{CE} = 2.0\text{ V}, I_C = 200\text{ mA}^\dagger$	5	—	—	6.0	V	
			$V_{CE} = 2.0\text{ V}, I_C = 275\text{ mA}^\dagger$	5	—	—	7.0	V	
			$V_{CE} = 2.0\text{ V}, I_C = 350\text{ mA}^\dagger$	5	—	—	8.0	V	
ULS2005*	-55°C	$V_{CE} = 2.0\text{ V}, I_C = 350\text{ mA}$	5	—	—	3.0	V		
	+125°C	$V_{CE} = 2.0\text{ V}, I_C = 350\text{ mA}^\dagger$	5	—	—	2.4	V		
D-C Forward Current Transfer Ratio	$h_{FE}$	ULS2001*	-55°C	$V_{CE} = 2.0\text{ V}, I_C = 350\text{ mA}$	2	500	—	—	—
			+25°C	$V_{CE} = 2.0\text{ V}, I_C = 350\text{ mA}$	2	1000	—	—	—
Turn-On Delay	$t_{PLH}$	All	+25°C		8	—	250	1000	ns
Turn-Off Delay	$t_{PHL}$	All	+25°C		8	—	250	1000	ns
Clamp Diode Leakage Current	$I_R$	All		$V_R = 50\text{ V}$	6	—	—	50	$\mu\text{A}$
Clamp Diode Forward Voltage	$V_F$	All		$I_F = 350\text{ mA}^\dagger$	7	—	1.7	2.0	V

\*Complete part number includes a final letter to indicate package (EK = leadless ceramic chip carrier, H = ceramic/metal side-brazed, R = ceramic/glass cer-DIP).

NOTE 1: All limits stated apply to the complete Darlington series except as specified for a single device type.

NOTE 2: The  $I_{IN(OFF)}$  current limit guarantees against partial turn-on of the output.

NOTE 3: The  $V_{IN(ON)}$  voltage limit guarantees a minimum output sink current per the specified test conditions.

<sup>†</sup>Pulse Test,  $t_p \leq 1\ \mu\text{s}$ , see graph.

T-43-25

**ULS2011H/R THRU ULS2015H/R**  
**ELECTRICAL CHARACTERISTICS over operating temperature range (unless otherwise noted)**

Characteristic	Symbol	Applicable Devices	Test Conditions			Limits			
			Temp.	Voltage/Current	Fig.	Min.	Typ.	Max.	Units
Output Leakage Current	$I_{CEX}$	All		$V_{CE} = 50\text{ V}$	1A	—	—	100	$\mu\text{A}$
		ULS2012*		$V_{CE} = 50\text{ V}, V_{IN} = 6\text{ V}$	1B	—	—	500	$\mu\text{A}$
		ULS2014*		$V_{CE} = 50\text{ V}, V_{IN} = 1\text{ V}$	1B	—	—	500	$\mu\text{A}$
Collector-Emitter Saturation Voltage	$V_{CE(SAT)}$	All	-55°C	$I_C = 500\text{ mA}, I_B = 1100\text{ }\mu\text{A}$	2	—	1.8	2.1	V
				$I_C = 350\text{ mA}, I_B = 850\text{ }\mu\text{A}$	2	—	1.6	1.8	V
				$I_C = 200\text{ mA}, I_B = 550\text{ }\mu\text{A}$	2	—	1.3	1.5	V
			+25°C	$I_C = 500\text{ mA}, I_B = 600\text{ }\mu\text{A}$	2	—	1.7	1.9	V
				$I_C = 350\text{ mA}, I_B = 500\text{ }\mu\text{A}$	2	—	1.25	1.6	V
				$I_C = 200\text{ mA}, I_B = 350\text{ }\mu\text{A}$	2	—	1.1	1.3	V
			+125°C	$I_C = 500\text{ mA}^\dagger, I_B = 600\text{ }\mu\text{A}$	2	—	1.8	2.1	V
				$I_C = 350\text{ mA}^\dagger, I_B = 500\text{ }\mu\text{A}$	2	—	1.6	1.8	V
				$I_C = 200\text{ mA}^\dagger, I_B = 350\text{ }\mu\text{A}$	2	—	1.3	1.5	V
Input Current	$I_{IN(ON)}$	ULS2012*		$V_{IN} = 17\text{ V}$	3	480	850	1300	$\mu\text{A}$
		ULS2013*		$V_{IN} = 3.85\text{ V}$	3	650	930	1350	$\mu\text{A}$
		ULS2014*	$V_{IN} = 5.0\text{ V}$	3	240	350	500	$\mu\text{A}$	
			$V_{IN} = 12\text{ V}$	3	650	1000	1450	$\mu\text{A}$	
		ULS2015*		$V_{IN} = 3.0\text{ V}$	3	—	1500	2400	$\mu\text{A}$
	$I_{IN(OFF)}$	All	+125°C	$I_C = 500\text{ }\mu\text{A}$	4	25	50	—	$\mu\text{A}$
Input Voltage	$V_{IN(ON)}$	ULS2012*	-55°C	$V_{CE} = 2.0\text{ V}, I_C = 500\text{ mA}$	5	—	—	23.5	V
			+125°C	$V_{CE} = 2.0\text{ V}, I_C = 500\text{ mA}^\dagger$	5	—	—	17	V
		ULS2013*	-55°C	$V_{CE} = 2.0\text{ V}, I_C = 250\text{ mA}$	5	—	—	3.6	V
				$V_{CE} = 2.0\text{ V}, I_C = 300\text{ mA}$	5	—	—	3.9	V
				$V_{CE} = 2.0\text{ V}, I_C = 500\text{ mA}$	5	—	—	6.0	V
			+125°C	$V_{CE} = 2.0\text{ V}, I_C = 250\text{ mA}^\dagger$	5	—	—	2.7	V
		$V_{CE} = 2.0\text{ V}, I_C = 350\text{ mA}^\dagger$		5	—	—	3.0	V	
		$V_{CE} = 2.0\text{ V}, I_C = 500\text{ mA}^\dagger$		5	—	—	3.5	V	

\*Complete part number includes a final letter to indicate package (H = ceramic/metal side-brazed, R = ceramic/glass cer-DIP).

Continued next page...

NOTE 1: All limits stated apply to the complete Darlington series except as specified for a single device type.

NOTE 2: The  $I_{IN(OFF)}$  current limit guarantees against partial turn-on of the output.

NOTE 3: The  $V_{IN(ON)}$  voltage limit guarantees a minimum output sink current per the specified test conditions.

†Pulse Test,  $t_p \leq 1\text{ }\mu\text{s}$ , see graph.

## ULS2011H/R THRU ULS2015H/R ELECTRICAL CHARACTERISTICS continued

Characteristic	Symbol	Applicable Devices	Test Conditions			Limits			Units
			Temp.	Voltage/Current	Fig.	Min.	Typ.	Max.	
Input Voltage (cont.)	$V_{IN(ON)}$	ULS2014*	-55°C	$V_{CE} = 2.0\text{ V}, I_C = 275\text{ mA}$	5	—	—	10	V
				$V_{CE} = 2.0\text{ V}, I_C = 350\text{ mA}$	5	—	—	12	V
				$V_{CE} = 2.0\text{ V}, I_C = 500\text{ mA}$	5	—	—	17	V
			+125°C	$V_{CE} = 2.0\text{ V}, I_C = 275\text{ mA}^\dagger$	5	—	—	7.0	V
				$V_{CE} = 2.0\text{ V}, I_C = 350\text{ mA}^\dagger$	5	—	—	8.0	V
				$V_{CE} = 2.0\text{ V}, I_C = 500\text{ mA}^\dagger$	5	—	—	9.5	V
		ULS2015*	-55°C	$V_{CE} = 2.0\text{ V}, I_C = 350\text{ mA}$	5	—	—	3.0	V
				$V_{CE} = 2.0\text{ V}, I_C = 500\text{ mA}$	5	—	—	3.5	V
			+125°C	$V_{CE} = 2.0\text{ V}, I_C = 350\text{ mA}^\dagger$	5	—	—	2.4	V
		$V_{CE} = 2.0\text{ V}, I_C = 500\text{ mA}^\dagger$	5	—	—	2.6	V		
D-C Forward Current Transfer Ratio	$h_{FE}$	ULS2011*	-55°C	$V_{CE} = 2.0\text{ V}, I_C = 500\text{ mA}$	2	450	—	—	—
			+25°C	$V_{CE} = 2.0\text{ V}, I_C = 500\text{ mA}$	2	900	—	—	—
Turn-On Delay	$t_{PLH}$	All	+25°C		8	—	250	1000	ns
Turn-Off Delay	$t_{PHL}$	All	+25°C		8	—	250	1000	ns
Clamp Diode Leakage Current	$I_R$	All		$V_R = 50\text{ V}$	6	—	—	50	$\mu\text{A}$
Clamp Diode Forward Voltage	$V_F$	All		$I_F = 350\text{ mA}^\dagger$	7	—	1.7	2.0	V
				$I_F = 500\text{ mA}^\dagger$	7	—	—	2.5	V

\*Complete part number includes a final letter to indicate package (H = ceramic/metal side-brazed, R = ceramic/glass cer-DIP).

NOTE 1: All limits stated apply to the complete Darlington series except as specified for a single device type.

NOTE 2: The  $I_{IN(OFF)}$  current limit guarantees against partial turn-on of the output.

NOTE 3: The  $V_{IN(ON)}$  voltage limit guarantees a minimum output sink current per the specified test conditions.

$^\dagger$ Pulse Test,  $t_p \leq 1\ \mu\text{s}$ , see graph.

# 2001 THRU 2025 HIGH VOLTAGE HIGH-CURRENT DARLINGTON ARRAYS

T-43-25

## ULS2021H/R THRU ULS2025H/R ELECTRICAL CHARACTERISTICS over operating temperature range (unless otherwise noted)

Characteristic	Symbol	Applicable Devices	Test Conditions			Limits			
			Temp.	Voltage/Current	Fig.	Min.	Typ.	Max.	Units
Output Leakage Current	$I_{CEX}$	All		$V_{CE} = 95\text{ V}$	1A	—	—	100	$\mu\text{A}$
		ULS2022*		$V_{CE} = 95\text{ V}, V_{IN} = 6\text{ V}$	1B	—	—	500	$\mu\text{A}$
		ULS2024*	+25°C	$V_{CE} = 95\text{ V}, V_{IN} = 1\text{ V}$	1B	—	—	500	$\mu\text{A}$
			+125°C	$V_{CE} = 95\text{ V}, V_{IN} = 0.5\text{ V}$	1B	—	—	500	$\mu\text{A}$
Collector-Emitter Saturation Voltage	$V_{CE(SAT)}$	All	-55°C	$I_C = 350\text{ mA}, I_B = 850\text{ }\mu\text{A}$	2	—	1.6	1.8	V
				$I_C = 200\text{ mA}, I_B = 550\text{ }\mu\text{A}$	2	—	1.3	1.5	V
				$I_C = 100\text{ mA}, I_B = 350\text{ }\mu\text{A}$	2	—	1.1	1.3	V
			+25°C	$I_C = 350\text{ mA}, I_B = 500\text{ }\mu\text{A}$	2	—	1.25	1.6	V
				$I_C = 200\text{ mA}, I_B = 350\text{ }\mu\text{A}$	2	—	1.1	1.3	V
				$I_C = 100\text{ mA}, I_B = 250\text{ }\mu\text{A}$	2	—	0.9	1.1	V
			+125°C	$I_C = 350\text{ mA}^\dagger, I_B = 500\text{ }\mu\text{A}$	2	—	1.6	1.8	V
				$I_C = 200\text{ mA}^\dagger, I_B = 350\text{ }\mu\text{A}$	2	—	1.3	1.5	V
				$I_C = 100\text{ mA}, I_B = 250\text{ }\mu\text{A}$	2	—	1.1	1.3	V
Input Current	$I_{IN(ON)}$	ULS2022*		$V_{IN} = 17\text{ V}$	3	480	850	1300	$\mu\text{A}$
		ULS2023*		$V_{IN} = 3.85\text{ V}$	3	650	930	1350	$\mu\text{A}$
		ULS2024*		$V_{IN} = 5.0\text{ V}$	3	240	350	500	$\mu\text{A}$
				$V_{IN} = 12\text{ V}$	3	650	1000	1450	$\mu\text{A}$
		ULS2025*		$V_{IN} = 3.0\text{ V}$	3	—	1500	2400	$\mu\text{A}$
	$I_{IN(OFF)}$	All	+125°C	$I_C = 500\text{ }\mu\text{A}$	4	20	50	—	$\mu\text{A}$
Input Voltage	$V_{IN(ON)}$	ULS2022*	-55°C	$V_{CE} = 2.0\text{ V}, I_C = 300\text{ mA}$	5	—	—	18	V
			+125°C	$V_{CE} = 2.0\text{ V}, I_C = 300\text{ mA}^\dagger$	5	—	—	13	V
		ULS2023*	-55°C	$V_{CE} = 2.0\text{ V}, I_C = 200\text{ mA}$	5	—	—	3.3	V
				$V_{CE} = 2.0\text{ V}, I_C = 250\text{ mA}$	5	—	—	3.6	V
				$V_{CE} = 2.0\text{ V}, I_C = 300\text{ mA}$	5	—	—	3.9	V
		+125°C	$V_{CE} = 2.0\text{ V}, I_C = 200\text{ mA}^\dagger$	5	—	—	2.4	V	
			$V_{CE} = 2.0\text{ V}, I_C = 250\text{ mA}^\dagger$	5	—	—	2.7	V	
			$V_{CE} = 2.0\text{ V}, I_C = 300\text{ mA}^\dagger$	5	—	—	3.0	V	

\*Complete part number includes a final letter to indicate package (H = ceramic/metal side-brazed, R = ceramic/glass cer-DIP):

Continued next page...

NOTE 1: All limits stated apply to the complete Darlington series except as specified for a single device type.

NOTE 2: The  $I_{IN(OFF)}$  current limit guarantees against partial turn-on of the output.

NOTE 3: The  $V_{IN(ON)}$  voltage limit guarantees a minimum output sink current per the specified test conditions.

†Pulse Test,  $t_p \leq 1\text{ }\mu\text{s}$ , see graph.

## ULS2021H/R THRU ULS2025H/R ELECTRICAL CHARACTERISTICS continued

Characteristic	Symbol	Applicable Devices	Test Conditions			Limits			
			Temp.	Voltage/Current	Fig.	Min.	Typ.	Max.	Units
Input Voltage (cont.)	$V_{IN(ON)}$	ULS2024*	-55°C	$V_{CE} = 2.0 \text{ V}, I_C = 125 \text{ mA}$	5	—	—	6.0	V
				$V_{CE} = 2.0 \text{ V}, I_C = 200 \text{ mA}$	5	—	—	8.0	V
				$V_{CE} = 2.0 \text{ V}, I_C = 275 \text{ mA}$	5	—	—	10	V
				$V_{CE} = 2.0 \text{ V}, I_C = 350 \text{ mA}$	5	—	—	12	V
		ULS2025*	+125°C	$V_{CE} = 2.0 \text{ V}, I_C = 125 \text{ mA}$	5	—	—	5.0	V
				$V_{CE} = 2.0 \text{ V}, I_C = 200 \text{ mA}^\dagger$	5	—	—	6.0	V
				$V_{CE} = 2.0 \text{ V}, I_C = 275 \text{ mA}^\dagger$	5	—	—	7.0	V
				$V_{CE} = 2.0 \text{ V}, I_C = 350 \text{ mA}^\dagger$	5	—	—	8.0	V
D-C Forward Current Transfer Ratio	$h_{FE}$	ULS2021*	-55°C	$V_{CE} = 2.0 \text{ V}, I_C = 350 \text{ mA}$	2	500	—	—	—
			+25°C	$V_{CE} = 2.0 \text{ V}, I_C = 350 \text{ mA}$	2	1000	—	—	—
Turn-On Delay	$t_{PLH}$	All	+25°C		8	—	250	1000	ns
Turn-Off Delay	$t_{PHL}$	All	+25°C		8	—	250	1000	ns
Clamp Diode Leakage Current	$I_R$	All		$V_R = 95 \text{ V}$	6	—	—	50	$\mu\text{A}$
Clamp Diode Forward Voltage	$V_F$	All		$I_F = 350 \text{ mA}^\dagger$	7	—	1.7	2.0	V

\*Complete part number includes a final letter to indicate package (H = ceramic/metal side-brazed, R = ceramic/glass cer-DIP).

NOTE 1: All limits stated apply to the complete Darlington series except as specified for a single device type.

NOTE 2: The  $I_{IN(OFF)}$  current limit guarantees against partial turn-on of the output.

NOTE 3: The  $V_{IN(ON)}$  voltage limit guarantees a minimum output sink current per the specified test conditions.

$^\dagger$ Pulse Test,  $t_p \leq 1 \mu\text{s}$ , see graph.



T-43-25

TEST FIGURES

FIGURE 1A

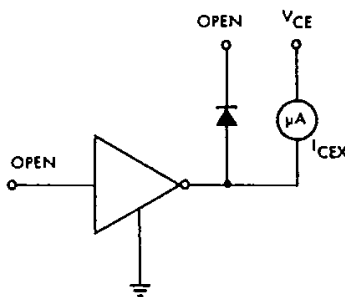

Dwg. No. A-9729A

FIGURE 1B

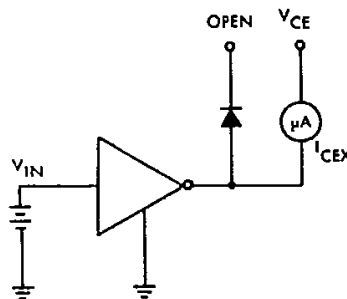

Dwg. No. A-9730A

FIGURE 2

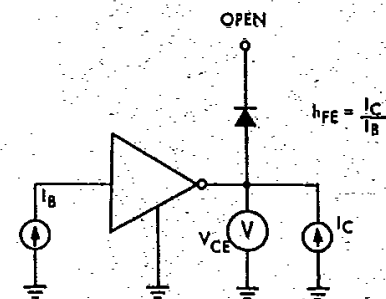

Dwg. No. A-9731

FIGURE 3

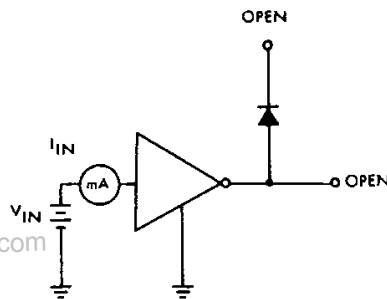

Dwg. No. A-9732

FIGURE 4

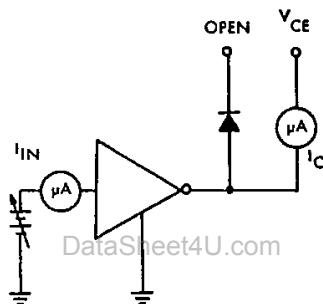

Dwg. No. A-9733A

FIGURE 5

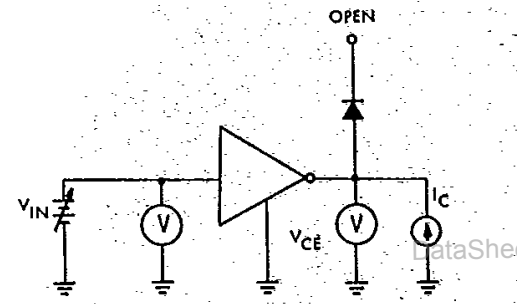

Dwg. No. A-9734A

FIGURE 6

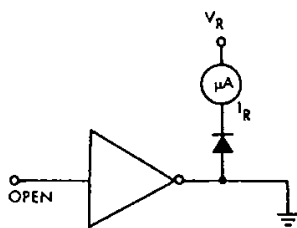

Dwg. No. A-9735A

FIGURE 7

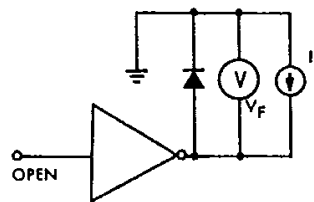

Dwg. No. A-9736

# 2001 THRU 2025 HIGH-VOLTAGE, HIGH-CURRENT DARLINGTON ARRAYS

J-43-25

	$V_{IN}$
ULS20X1*	3.5 V
ULS20X2*	13 V
ULS20X3*	3.5 V
ULS20X4*	12 V
ULS20X5*	3.5 V

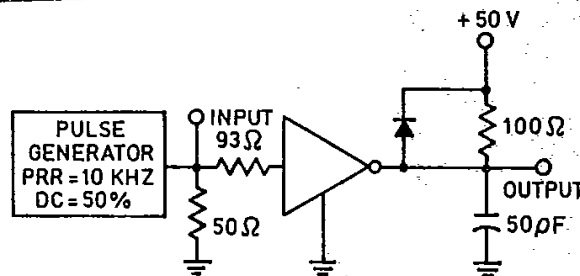

Dwg. No. A-13,273

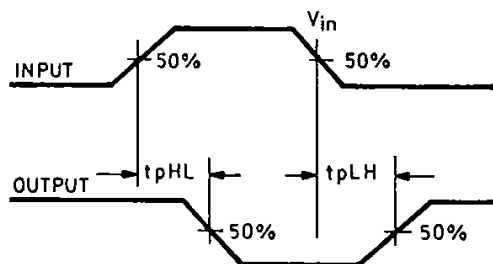

Dwg. No. A-13,272

\* Complete part number includes a final letter to indicate package.

X= Digit to identify specific device. Specification shown applies to family of devices with remaining digits as shown.

FIGURE 8

COLLECTOR CURRENT AS A FUNCTION OF SATURATION VOLTAGE

DataSheet4U.com

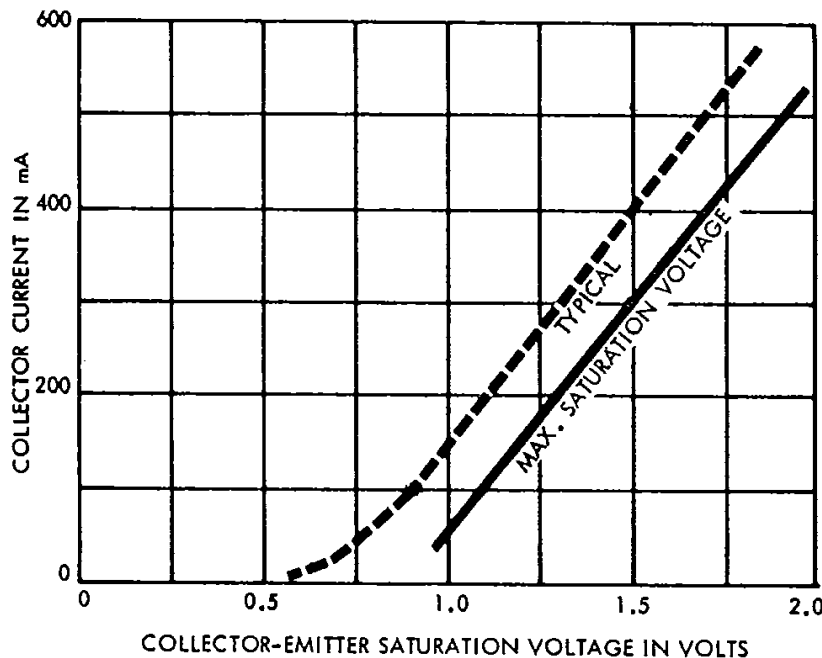

Dwg. No. A-9754C

COLLECTOR CURRENT AS A FUNCTION OF INPUT CURRENT

DataSheet4U.com

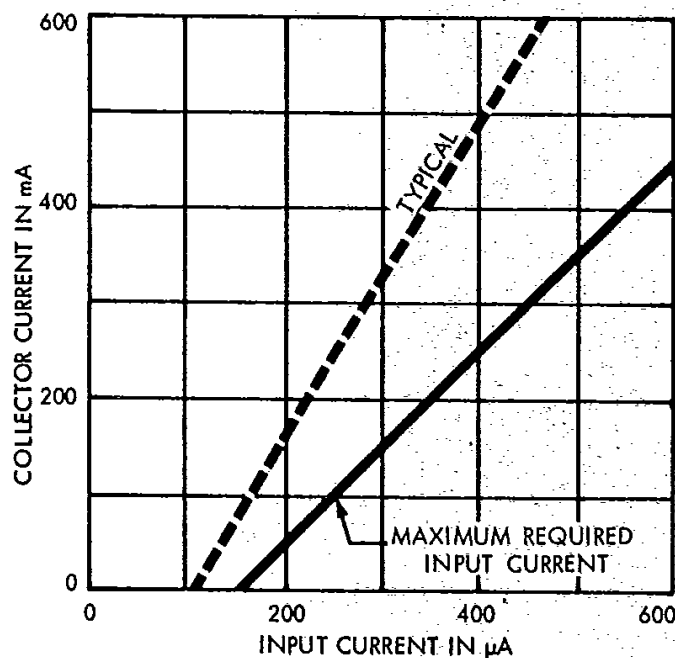

Dwg. No. A-10,872B

# 2001 THRU 2025 HIGH-VOLTAGE, HIGH-CURRENT DARLINGTON ARRAYS

T-43-25

## ULS20XXH

**RECOMMENDED PEAK CURRENT  
AS A FUNCTION OF DUTY CYCLE AT +50°C**

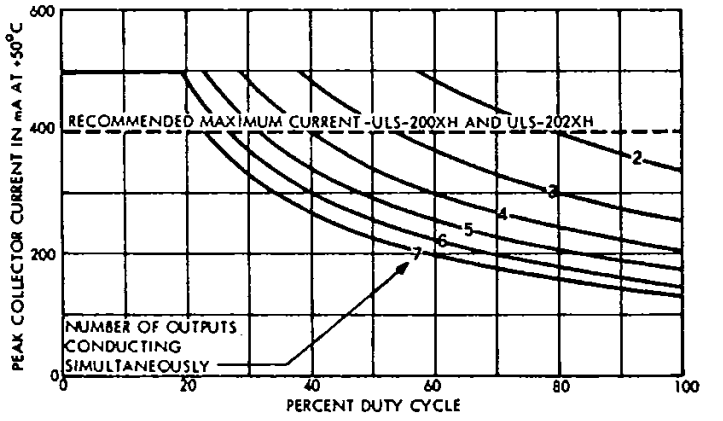

Dwg. No. A-10,197B

**RECOMMENDED PEAK CURRENT  
AS A FUNCTION OF DUTY CYCLE AT +75°C**

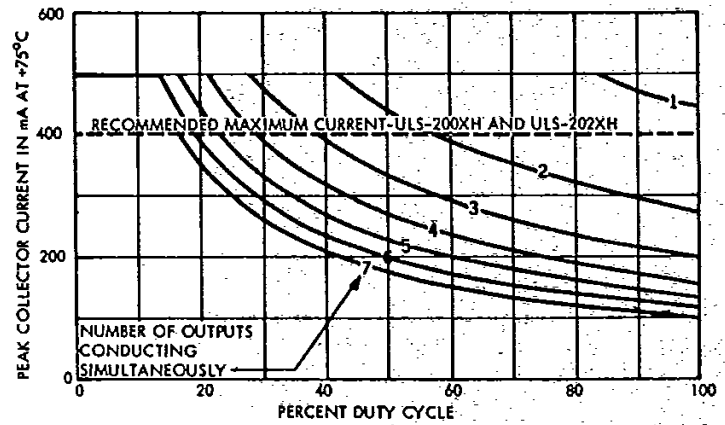

Dwg. No. A-10,199B

**RECOMMENDED PEAK CURRENT  
AS A FUNCTION OF DUTY CYCLE AT +100°C**

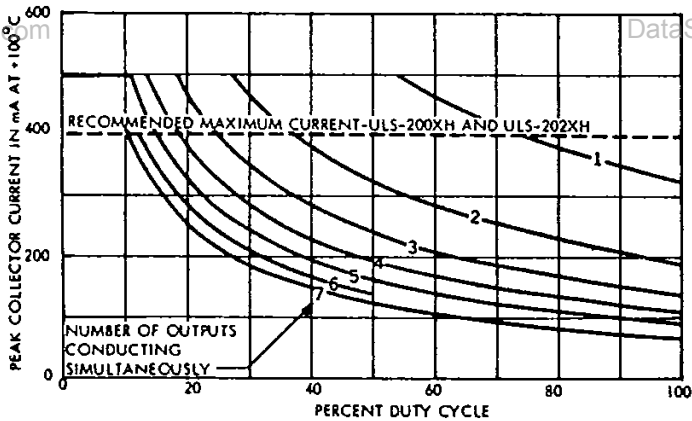

Dwg. No. A-10,200B

**RECOMMENDED PEAK CURRENT  
AS A FUNCTION OF DUTY CYCLE AT +125°C**

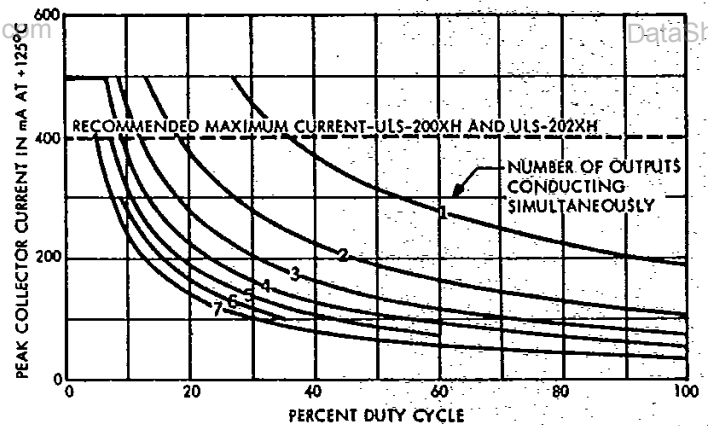

Dwg. No. A-10,201B

*X = digit to identify specific device. Specification or limit shown applies to family of devices with remaining digits as shown.*

# 2001 THRU 2025 HIGH-VOLTAGE, HIGH-CURRENT DARLINGTON ARRAYS

T-413-25

## ULS20XXR

**RECOMMENDED PEAK CURRENT  
AS A FUNCTION OF DUTY CYCLE AT +50°C**

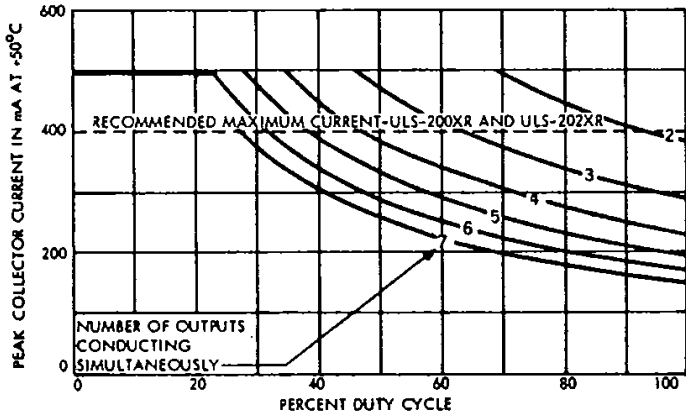

Dwg. No. A-10,883B

**RECOMMENDED PEAK CURRENT  
AS A FUNCTION OF DUTY CYCLE AT +75°C**

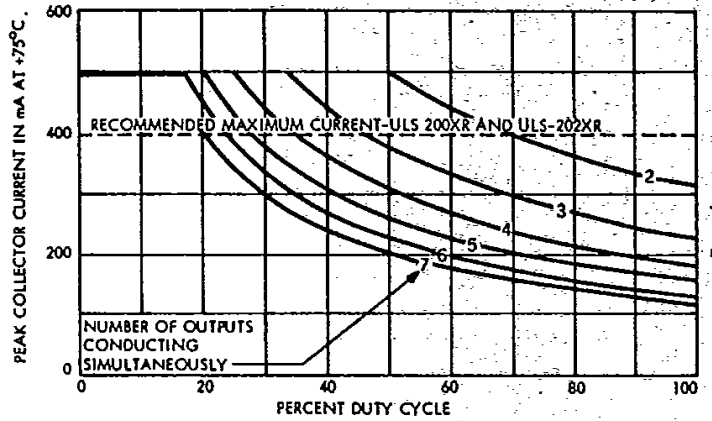

Dwg. No. A-10,887B

**RECOMMENDED PEAK CURRENT  
AS A FUNCTION OF DUTY CYCLE AT +100°C**

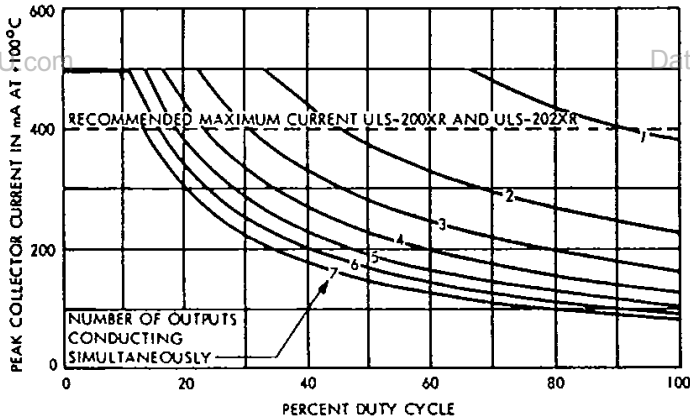

Dwg. No. A-12,434

**RECOMMENDED PEAK CURRENT  
AS A FUNCTION OF DUTY CYCLE AT +125°C**

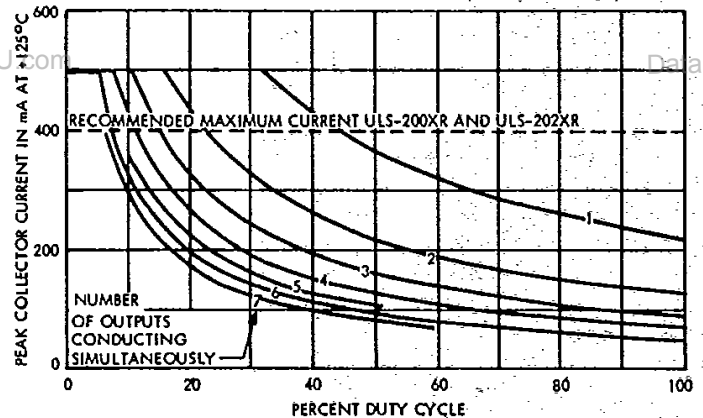

Dwg. No. A-12,435

*X = digit to identify specific device. Specification or limit shown applies to family of devices with remaining digits as shown.*

7-43-25

INPUT CURRENT AS A FUNCTION OF INPUT VOLTAGE

ULS20X2°

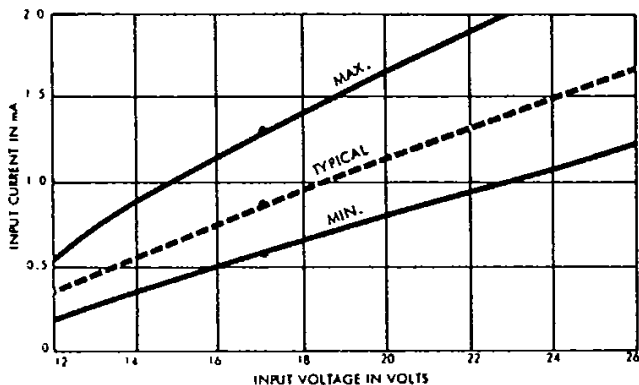

Dwg. No. A-10,225A

ULS20X3°

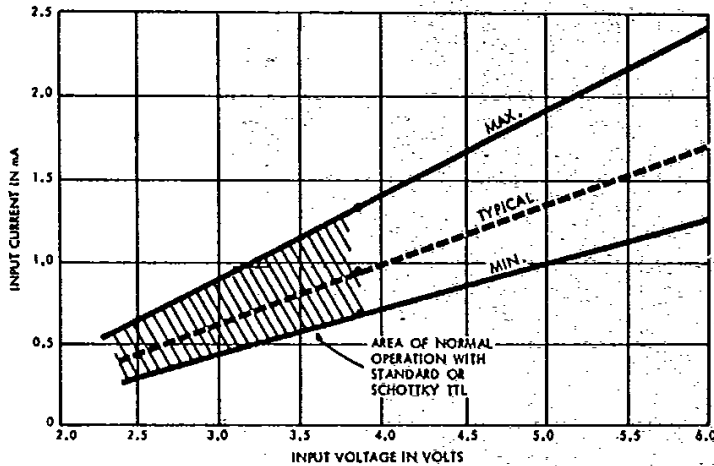

Dwg. No. A-10,224A

ULS20X4°

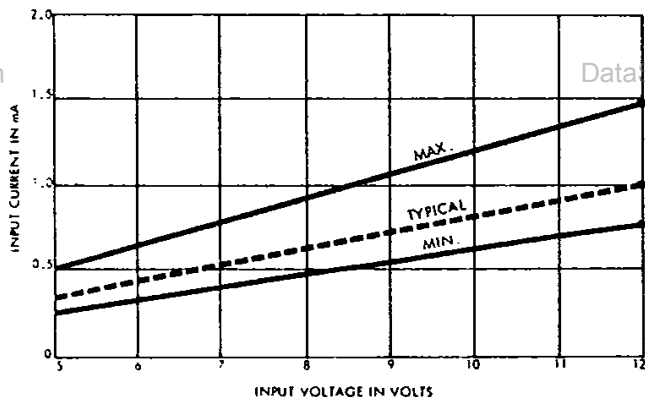

Dwg. No. A-10,226A

ULS20X5°

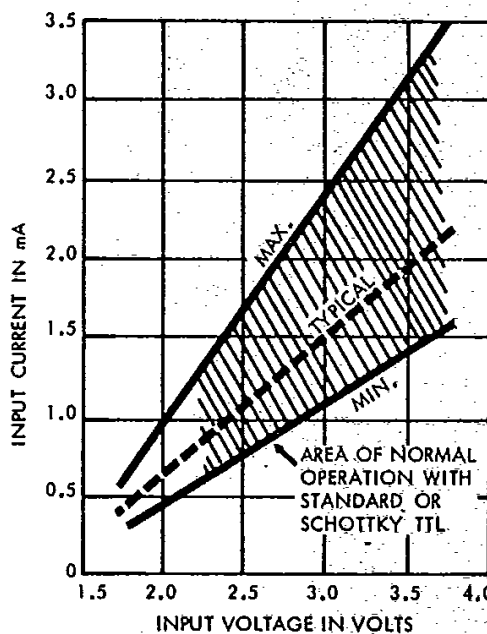

Dwg. No. A-10,874A

X = digit to identify specific device. Specification or limit shown applies to family of devices with remaining digits as shown.