

PLEASE CHECK WWW.MOLEX.COM FOR LATEST PART INFORMATION

Part Number: [0705510015](#)
Status: **Active**
Overview: [cgrid_sl_products](#)
Description: 2.54mm (.100") Pitch SL™ Header, Single Row, Right Angle, .120" Pocket, Shrouded, with Beveled Plastic Peg, 16 Circuits, Tin (Sn) Plating

Documents:

3D Model	Product Specification PS-70400 (PDF)
Drawing (PDF)	Product Specification PS-70541 (PDF)
Packaging Specification (PDF)	RoHS Certificate of Compliance (PDF)

Agency Certification

CSA	LR19980
UL	E29179

General

Product Family	PCB Headers
Series	70551
Application	Wire-to-Board
Overview	cgrid_sl_products
Product Name	SL™

Physical

Breakaway	No
Circuits (Loaded)	16
Circuits (maximum)	16
Color - Resin	Black
Durability (mating cycles max)	25
First Mate / Last Break	No
Flammability	94V-0
Glow-Wire Compliant	No
Guide to Mating Part	No
Keying to Mating Part	None
Lock to Mating Part	Yes
Material - Metal	Brass, Phosphor Bronze
Material - Plating Mating	Tin
Material - Plating Termination	Tin
Material - Resin	High Temperature Thermoplastic
Number of Rows	1
Orientation	Right Angle
PC Tail Length (in)	0.130 In
PC Tail Length (mm)	3.30 mm
PCB Locator	Yes
PCB Retention	Yes
PCB Thickness Recommended (in)	0.062 In
PCB Thickness Recommended (mm)	1.60 mm
Packaging Type	Tube
Pitch - Mating Interface (in)	0.100 In
Pitch - Mating Interface (mm)	2.54 mm
Plating min: Mating (µin)	150
Plating min: Mating (µm)	3.75
Plating min: Termination (µin)	150
Plating min: Termination (µm)	3.75
Polarized to Mating Part	Yes
Shrouded	Fully
Stackable	No

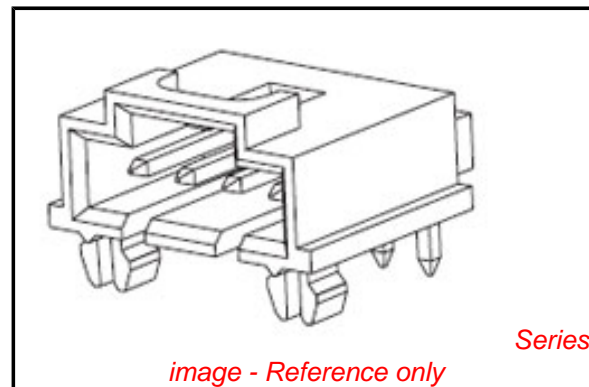

image - Reference only

EU RoHS

ELV and RoHS Compliant
REACH SVHC
 Not Reviewed
Halogen-Free Status
Not Reviewed

China RoHS



Need more information on product environmental compliance?

Email productcompliance@molex.com
 For a multiple part number RoHS Certificate of Compliance, [click here](#)

Please visit the [Contact Us](#) section for any non-product compliance questions.

Search Parts in this Series

[70551Series](#)

Mates With

SL™ Crimp Housing [70066](#) , [70430](#) , [70400](#)

Temperature Range - Operating
Termination Interface: Style

-40°C to +105°C
Through Hole

Electrical

Current - Maximum per Contact
Voltage - Maximum

3A
250V

Solder Process Data

Lead-free Process Capability

Wave Capable (TH only)

Material Info

Reference - Drawing Numbers

Packaging Specification
Product Specification
Sales Drawing

PK-70873-0015
PS-70400, PS-70541
SDA-70551-****

This document was generated on 05/27/2010

PLEASE CHECK WWW.MOLEX.COM FOR LATEST PART INFORMATION



**ALTERNATIVE CORING
MANUFACTURER'S OPTION**

CKT. SIZE	DIM. "A"		DIM. "B"		DIM. "C"		DIM. "Z"	
	MM	IN.	MM	IN.	MM	IN.	MM	IN.
2	2.54	.100	5.33	.210	5.08	.200	8.64	.340
3	5.08	.200	8.13	.320	7.62	.300	11.43	.450
4	7.62	.300	10.67	.420	10.16	.400	13.97	.550
5	10.16	.400	13.21	.520	12.70	.500	16.51	.650
6	12.70	.500	15.75	.620	15.24	.600	19.05	.750
7	15.24	.600	18.29	.720	17.78	.700	21.59	.850
8	17.78	.700	20.83	.820	20.32	.800	24.13	.950
9	20.32	.800	23.37	.920	22.86	.900	26.67	1.050
10	22.86	.900	25.91	1.020	25.40	1.000	29.21	1.150
11	25.40	1.000	28.45	1.120	27.94	1.100	31.75	1.250
12	27.94	1.100	30.99	1.220	30.48	1.200	34.29	1.350
13	30.48	1.200	33.53	1.320	33.02	1.300	36.83	1.450
14	33.02	1.300	36.07	1.420	35.56	1.400	39.37	1.550
15	35.56	1.400	38.61	1.520	38.10	1.500	41.91	1.650
16	38.10	1.500	41.15	1.620	40.64	1.600	44.45	1.750
17	40.64	1.600	43.69	1.720	43.18	1.700	46.99	1.850
18	43.18	1.700	46.23	1.820	45.72	1.800	49.53	1.950
19	45.72	1.800	48.77	1.920	48.26	1.900	52.07	2.050
20	48.26	1.900	51.31	2.020	50.80	2.000	54.61	2.150
21	50.80	2.000	53.85	2.120	53.34	2.100	57.15	2.250
22	53.34	2.100	56.39	2.220	55.88	2.200	59.69	2.350
23	55.88	2.200	58.93	2.320	58.42	2.300	62.23	2.450
24	58.42	2.300	61.47	2.420	60.96	2.400	64.77	2.550
25	60.96	2.400	64.01	2.520	63.50	2.500	67.31	2.750



- NOTES:
 1. MATERIAL:
 HOUSING: GLASS FILLED POLYESTER; UL94V-0
 COLOR: BLACK
 PIN MATERIAL: PHOSPHOR BRONZE
 2. HEADER TO BE USED WITH OPTION "G" 70400 AND 70430 SERIES SL CONNECTORS
 3. REFER TO MOLEX PRODUCT SPECIFICATION PS-70541
 4. STANDARD PACKAGING PER PK-70873-0015
 5. DIMENSIONS WITHOUT TOLERANCE ARE SHOWN FOR REFERENCE ONLY
 6. MEASURE POINT FOR PLATING THICKNESS

- PLATING CODES:
 TIN - 3.81 MICROMETERS/15 MICROINCHES MINIMUM BRIGHT TIN PLATE OVER 1.27 MICROMETERS/50 MICROINCHES MINIMUM NICKEL PLATE
 15 GOLD - 0.38 MICROMETERS/15 MICROINCHES MINIMUM GOLD PLATE IN SELECT AREA 1.91 MICROMETERS/75 MICROINCHES MINIMUM MATTE TIN PLATE IN SELECT AREA OVER 1.27 MICROMETERS/50 MICROINCHES MINIMUM NICKEL PLATE OVERALL
 30 GOLD - 0.76 MICROMETERS/15 MICROINCHES MINIMUM GOLD PLATE IN SELECT AREA 1.91 MICROMETERS/75 MICROINCHES MINIMUM MATTE TIN PLATE IN SELECT AREA OVER 1.27 MICROMETERS/50 MICROINCHES MINIMUM NICKEL PLATE OVERALL

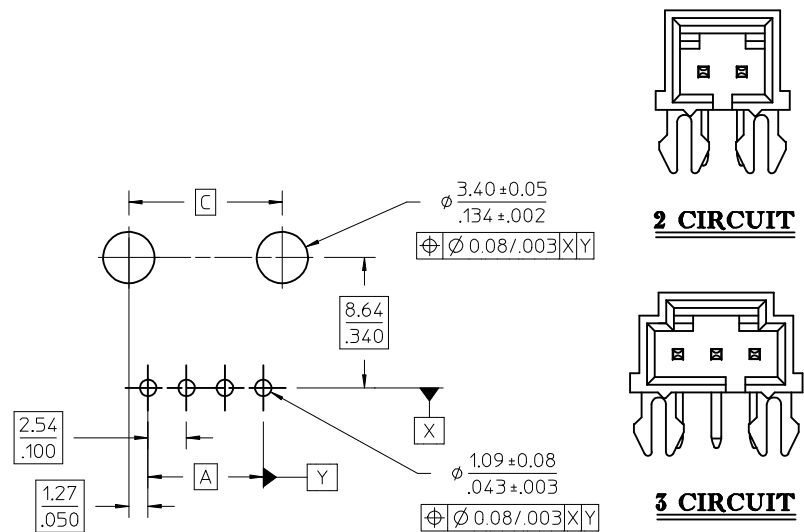





RECOMMENDED P.C. BOARD LAYOUT
 (FOR USE WITH (1.57)/.062 THICK BOARD)

ADD DIMENSION "Z" EC NO: UCP2010-1081 DR: WMS BARRA 2009/10/26 CHKD: 2009/11/09 APPR: SWILLER 2009/11/09	QUALITY SYMBOLS ▽=0 ▽=0	GENERAL TOLERANCES (UNLESS SPECIFIED)		DIMENSION STYLE MM/IN		SCALE	DESIGN UNITS	THIRD ANGLE PROJECTION
		mm	INCH	DRAWN BY	DATE	TITLE	INCH	
K	REVISION DESCRIPTION	4 PLACES ± --- ± ---		AAB	1993/05/13	SL RIGHT ANGLE HEADER W/LATCH & SPLIT PEGS (2.54)/.100 CENTERS MOLEX INCORPORATED SDA-70551-**** SHEET NO. 1 OF 2		
		3 PLACES ± --- ± .005		CHECKED BY DATE				
		2 PLACES ± 0.13 ± .010		AAB 1993/05/13				
		1 PLACE ± 0.25 ± ---		APPROVED BY DATE WAZ 1993/05/13				
ANGULAR ± 1/2°		MATERIAL NO. SEE TABLE		DOCUMENT NO. SEE TABLE				
DRAFT WHERE APPLICABLE MUST REMAIN WITHIN DIMENSIONS		THIS DRAWING CONTAINS INFORMATION THAT IS PROPRIETARY TO MOLEX INCORPORATED AND SHOULD NOT BE USED WITHOUT WRITTEN PERMISSION						

13		12		11		10		9		8		7		6		5		4		3		2		1	
ENGINEERING NUMBER A-7055 I	MANUFACTURE RELEASE STATUS											CONNECTOR END PLATING				P.C. BOARD END PLATING									
		D		E		TYPE		H MEAS.		TYPE		K MEAS.													
-0001-0024	R.F.M.							(3.30) .130	(6.10) .240			TIN	(2.54) .100			TIN	(1.27) .050								
-0036-0059	R.F.M.							(3.30) .130	(6.10) .240			15 GOLD	(2.54) .100			TIN	(1.27) .050								
-0071-0094	R.F.M.							(3.30) .130	(6.10) .240			30 GOLD	(2.54) .100			TIN	(1.27) .050								

CKTS	ITEM NUMBER	ITEM NUMBER	ITEM NUMBER	ITEM NUMBER	ITEM NUMBER	ITEM NUMBER	ITEM NUMBER	ITEM NUMBER	ITEM NUMBER	CKTS
02	705-51-0001	705-51-0036	705-51-0071							02
03	705-51-0002	705-51-0037	705-51-0072							03
04	705-51-0003	705-51-0038	705-51-0073							04
05	705-51-0004	705-51-0039	705-51-0074							05
06	705-51-0005	705-51-0040	705-51-0075							06
07	705-51-0006	705-51-0041	705-51-0076							07
08	705-51-0007	705-51-0042	705-51-0077							08
09	705-51-0008	705-51-0043	705-51-0078							09
10	705-51-0009	705-51-0044	705-51-0079							10
11	705-51-0010	705-51-0045	705-51-0080							11
12	705-51-0011	705-51-0046	705-51-0081							12
13	705-51-0012	705-51-0047	705-51-0082							13
14	705-51-0013	705-51-0048	705-51-0083							14
15	705-51-0014	705-51-0049	705-51-0084							15
16	705-51-0015	705-51-0050	705-51-0085							16
17	705-51-0016	705-51-0051	705-51-0086							17
18	705-51-0017	705-51-0052	705-51-0087							18
19	705-51-0018	705-51-0053	705-51-0088							19
20	705-51-0019	705-51-0054	705-51-0089							20
21	705-51-0020	705-51-0055	705-51-0090							21
22	705-51-0021	705-51-0056	705-51-0091							22
23	705-51-0022	705-51-0057	705-51-0092							23
24	705-51-0023	705-51-0058	705-51-0093							24
25	705-51-0024	705-51-0059	705-51-0094							25

SEE SHEET 1 EC NO: UCP2010-1081 DRWNGS BARRA 2009/10/26 CHKD: 2009/11/09 APPR: MILLER 2009/11/09	QUALITY SYMBOLS  = 0  = 0	GENERAL TOLERANCES (UNLESS SPECIFIED)		DIMENSION STYLE MM/IN		SCALE 4:1	DESIGN UNITS INCH	 THIRD ANGLE PROJECTION	
		4 PLACES ± --- ± ---	DRAWN BY AAB	DATE 1993/05/13	SL RIGHT ANGLE HEADER W/LATCH & SPLIT PEGS (2.54)/.100 CENTERS				
		3 PLACES ± --- ± .005	CHECKED BY AAB	DATE 1993/05/13					
		2 PLACES ± 0.13 ± .010	APPROVED BY WAZ		DATE 1993/05/13	 MOLEX INCORPORATED		MATERIAL NO. SEE TABLE	DOCUMENT NO. SDA-70551-****
1 PLACE ± 0.25 ± ---	DRAFT WHERE APPLICABLE MUST REMAIN WITHIN DIMENSIONS		SIZE 		THIS DRAWING CONTAINS INFORMATION THAT IS PROPRIETARY TO MOLEX INCORPORATED AND SHOULD NOT BE USED WITHOUT WRITTEN PERMISSION				