



N-Channel Depletion-Mode Vertical DMOS FETs

Features

- ▶ High input impedance
- ▶ Low input capacitance
- ▶ Fast switching speeds
- ▶ Low on resistance
- ▶ Free from secondary breakdown
- ▶ Low input and output leakage

Applications

- ▶ Normally-on switches
- ▶ Solid state relays
- ▶ Converters
- ▶ Linear amplifiers
- ▶ Constant current sources
- ▶ Power supply circuits
- ▶ Telecom

General Description

The DN2530 is a low threshold depletion-mode (normally-on) transistor utilizing an advanced vertical DMOS structure and Supertex's well-proven silicon-gate manufacturing process. This combination produces a device with the power handling capabilities of bipolar transistors and with the high input impedance and positive temperature coefficient inherent in MOS devices. Characteristic of all MOS structures, this device is free from thermal runaway and thermally-induced secondary breakdown.

Supertex's vertical DMOS FETs are ideally suited to a wide range of switching and amplifying applications where high breakdown voltage, high input impedance, low input capacitance, and fast switching speeds are desired.

Ordering Information

BV _{DSX} / BV _{DGX}	R _{DS(ON)} (max)	I _{DSS} (min)	Package Options	
			TO-243AA ¹	TO-92
300V	12Ω	200mA	DN2530N8	DN2530N3
			DN2530N8-G	DN2530N3-G



^{-G} indicates package is RoHS compliant ('Green')
¹Same as SOT-89. Products shipped on 2000 piece carrier tape reels.

Absolute Maximum Ratings

Parameter	Value
Drain-to-source voltage	BV _{DSX}
Drain-to-gate voltage	BV _{DGX}
Gate-to-source voltage	±20V
Operating and storage temperature	-55°C to +150°C
Soldering temperature*	300°C

Absolute Maximum Ratings are those values beyond which damage to the device may occur. Functional operation under these conditions is not implied. Continuous operation of the device at the absolute rating level may affect device reliability. All voltages are referenced to device ground.

*Distance of 1.6mm from case for 10 seconds.

Pin Configurations

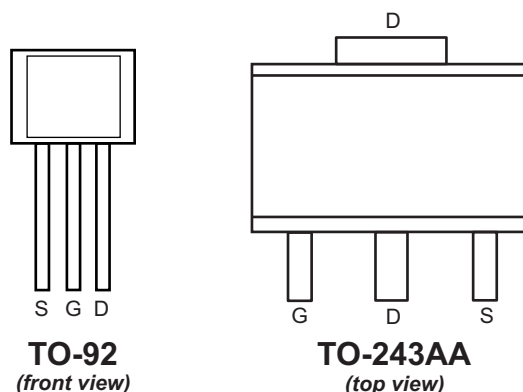

Thermal Characteristics

Package	I_D (continuous) ¹	I_D (pulsed)	Power Dissipation @ $T_A = 25^\circ\text{C}$	θ_{jc} ($^\circ\text{C/W}$)	θ_{ja} ($^\circ\text{C/W}$)	I_{DR}^1	I_{DRM}
TO-243AA	200mA	500mA	1.6W ²	15	78 ²	200mA	500mA
TO-92	175mA	500mA	0.74W	125	170	175mA	500mA

Notes:

- I_D (continuous) is limited by max rated T_j
- Mounted on FR4 board, 25mm x 25mm x 1.57mm

Electrical Characteristics

Symbol	Parameter	Min	Typ	Max	Units	Conditions
BV_{DSX}	Drain-to-source breakdown voltage	300	-	-	V	$V_{GS} = -5.0\text{V}, I_D = 100\mu\text{A}$
$V_{GS(OFF)}$	Gate-to-source OFF voltage	-1.0	-	-3.5	V	$V_{DS} = 25\text{V}, I_D = 10\mu\text{A}$
$\Delta V_{GS(OFF)}$	Change in $V_{GS(OFF)}$ with temperature	-	-	4.5	mV/ $^\circ\text{C}$	$V_{DS} = 25\text{V}, I_D = 10\mu\text{A}$
I_{GSS}	Gate body leakage current	-	-	100	nA	$V_{GS} = \pm 20\text{V}, V_{DS} = 0\text{V}$
$I_{D(OFF)}$	Drain-to-source leakage current	-	-	10	μA	$V_{DS} = \text{Max rating}, V_{GS} = -10\text{V}$
		-	-	1.0	mA	$V_{DS} = 0.8 \text{ Max Rating}, V_{GS} = -10\text{V}, T_A = 125^\circ\text{C}$
I_{DSS}	Saturated drain-to-source current	200	-	-	mA	$V_{GS} = 0\text{V}, V_{DS} = 25\text{V}$
$R_{DS(ON)}$	Static drain-to-source ON-state resistance	-	-	12	Ω	$V_{GS} = 0\text{V}, I_D = 150\text{mA}$
$\Delta R_{DS(ON)}$	Change in $R_{DS(ON)}$ with temperature	-	-	1.1	%/ $^\circ\text{C}$	$V_{GS} = 0\text{V}, I_D = 150\text{mA}$
G_{FS}	Forward transconductance	300	-	-	mmho	$V_{DS} = 10\text{V}, I_D = 150\text{mA}$
C_{ISS}	Input capacitance	-	-	300	pF	$V_{GS} = -10\text{V}, V_{DS} = 25\text{V}, f = 1\text{MHz}$
C_{OSS}	Common source output capacitance	-	-	30		
C_{RSS}	Reverse transfer capacitance	-	-	5		
$t_{d(ON)}$	Turn-ON delay time	-	-	10	ns	$V_{DD} = 25\text{V}, I_D = 150\text{mA}, R_{GEN} = 25\Omega,$
t_r	Rise time	-	-	15		
$t_{d(OFF)}$	Turn-OFF delay time	-	-	15		
t_f	Fall time	-	-	20		
V_{SD}	Diode forward voltage drop	-	-	1.8	V	$V_{GS} = -10\text{V}, I_{SD} = 150\text{mA}$
t_{rr}	Reverse recovery time	-	800	-	ns	$V_{GS} = -10\text{V}, I_{SD} = 1.0\text{A}$

Notes:

- All D.C. parameters 100% tested at 25°C unless otherwise stated. (Pulse test: 300µs pulse, 2% duty cycle.)
- All A.C. parameters sample tested.

Switching Waveforms and Test Circuit

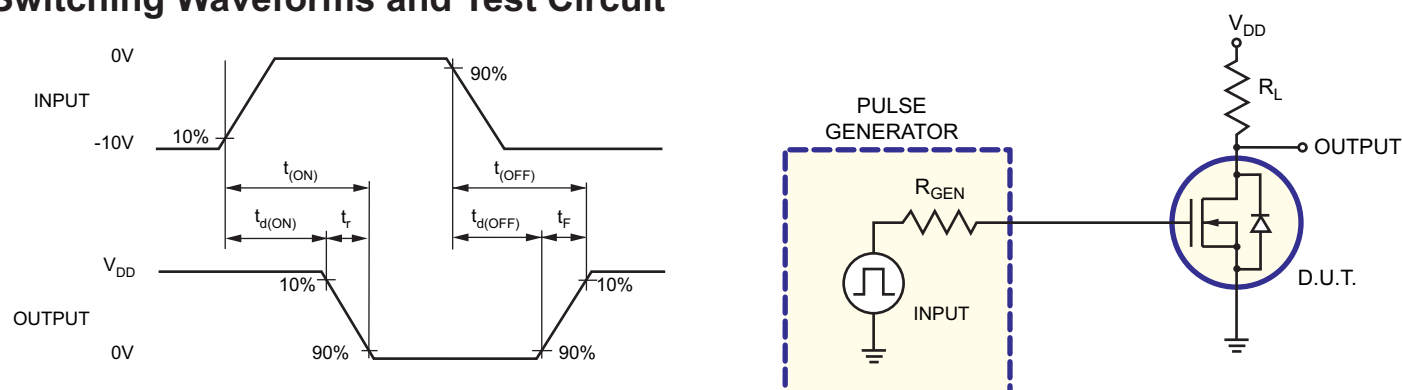

Typical Performance Curves

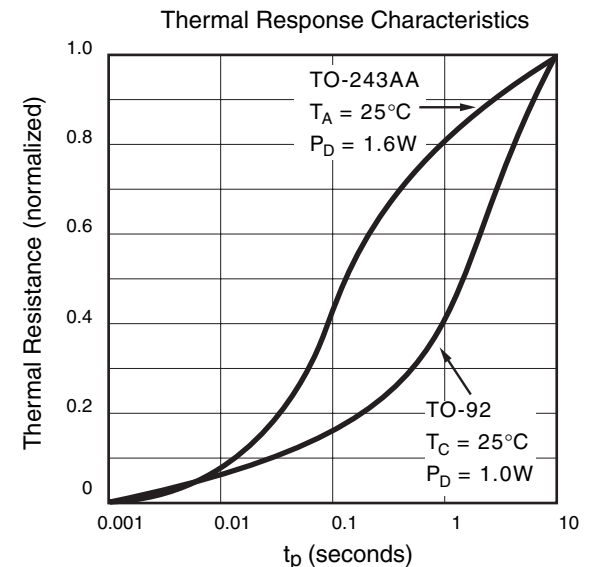
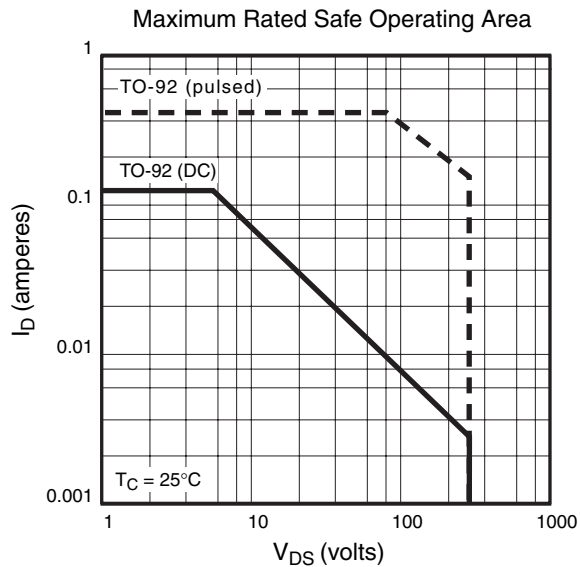
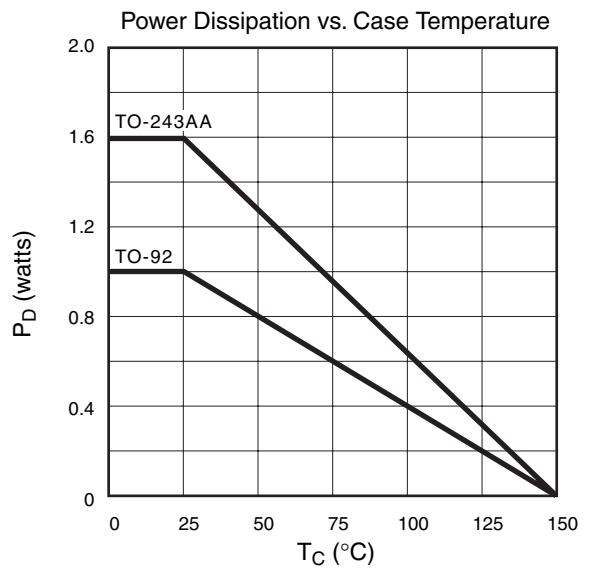
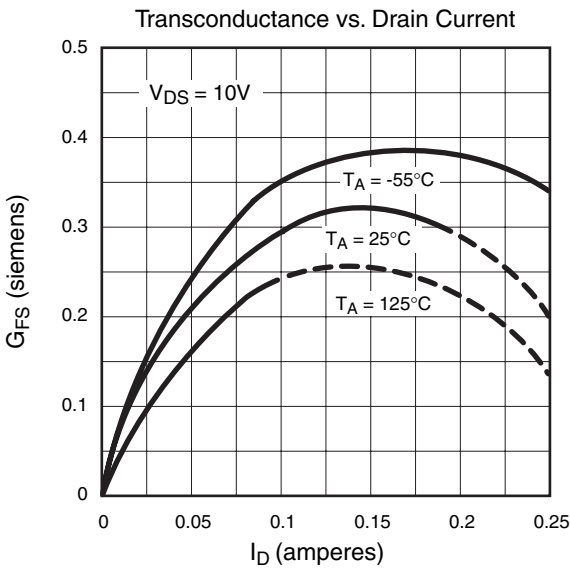
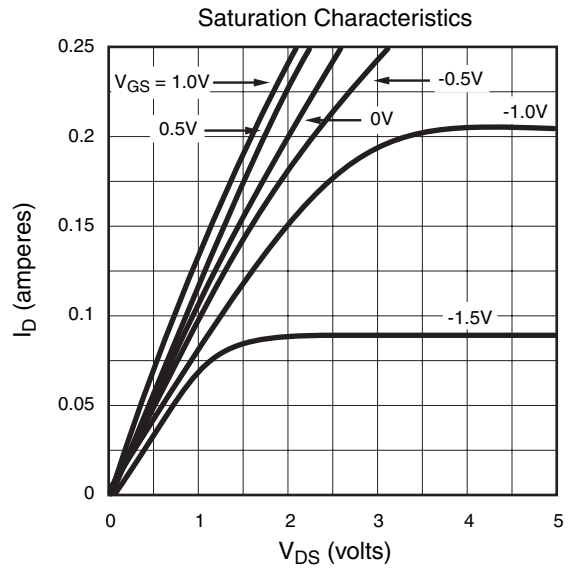
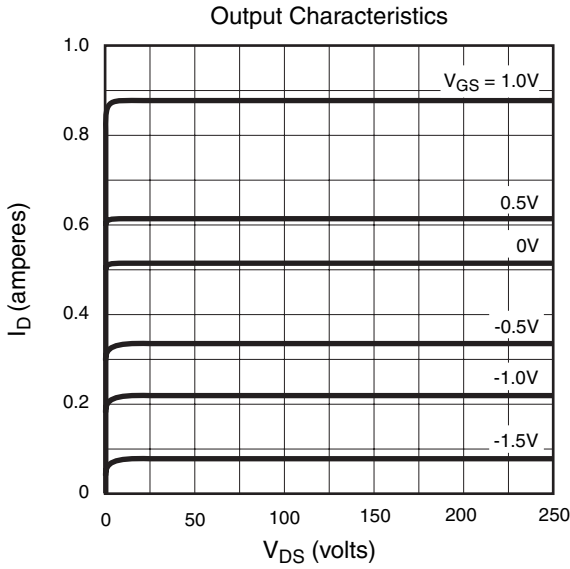

Typical Performance Curves (cont.)

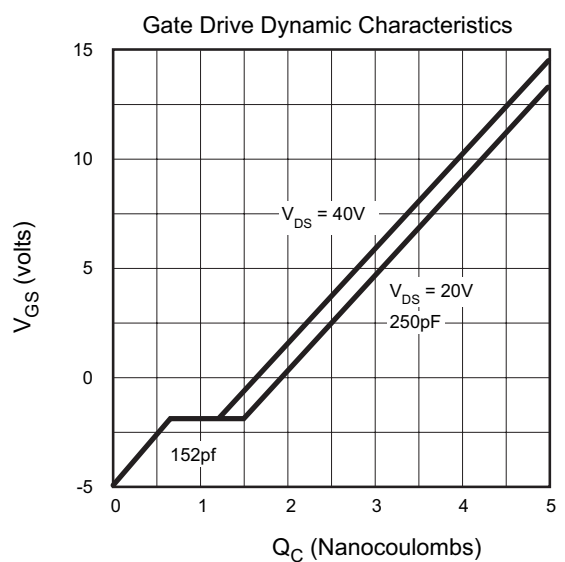
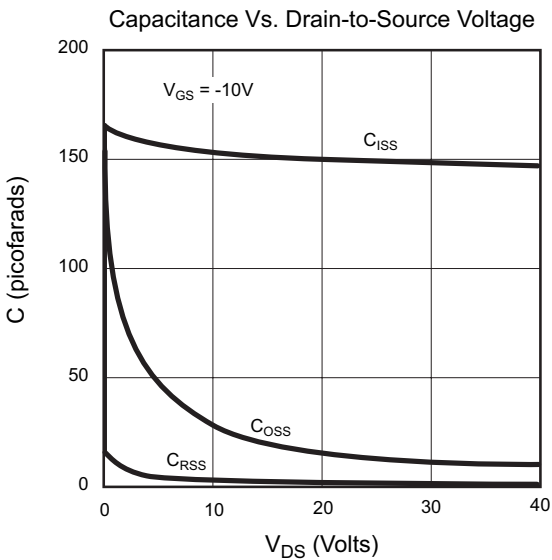
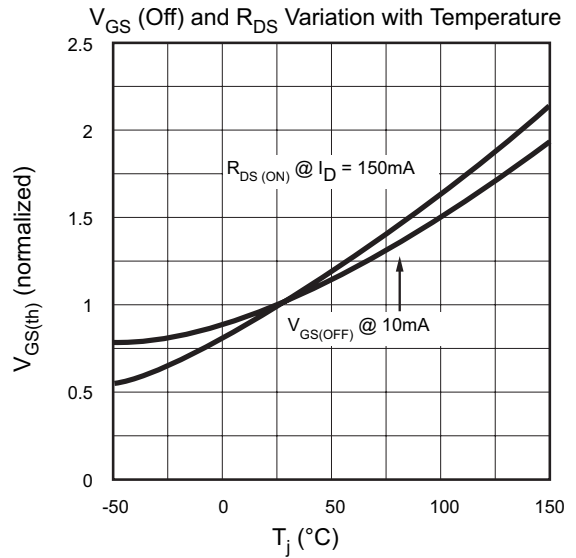
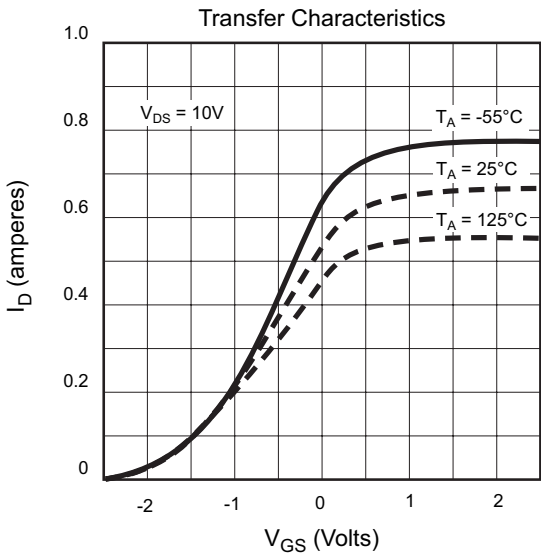
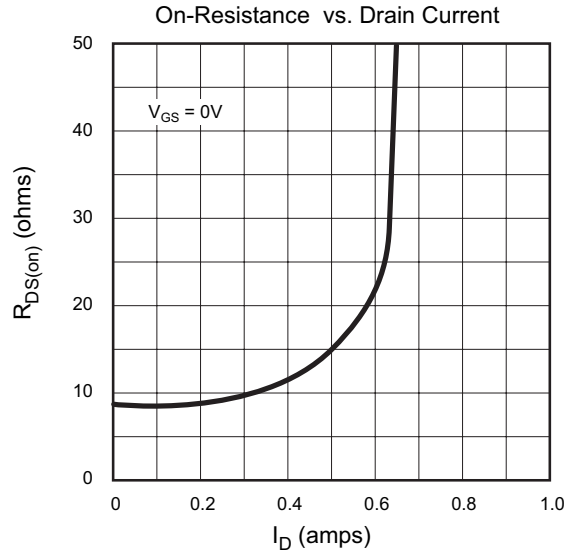
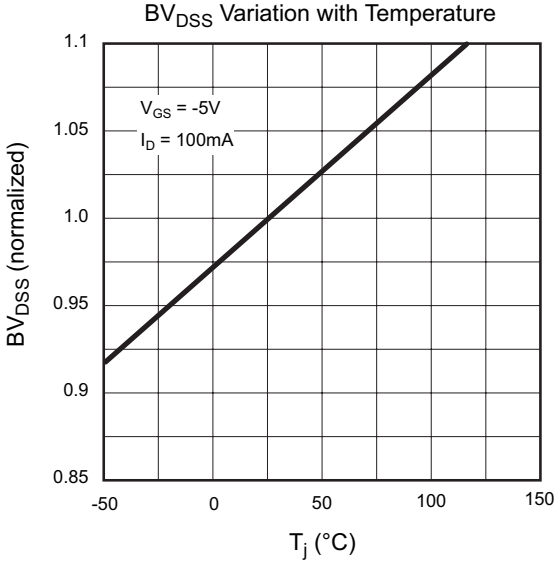

3-Lead TO-92 Package Outline (N3)

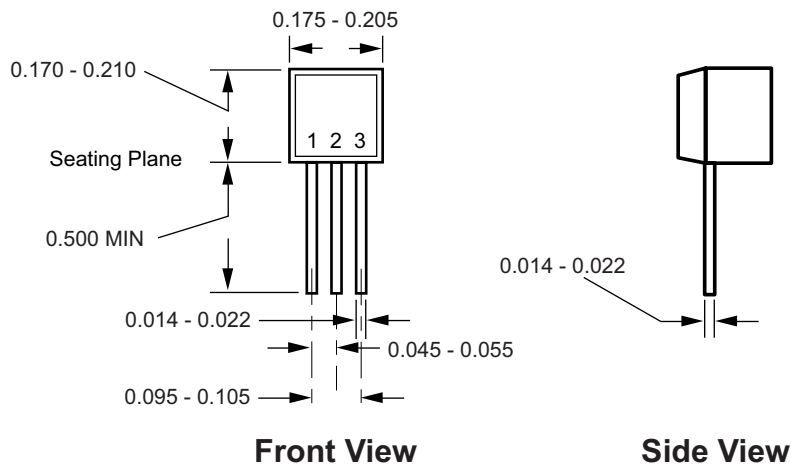
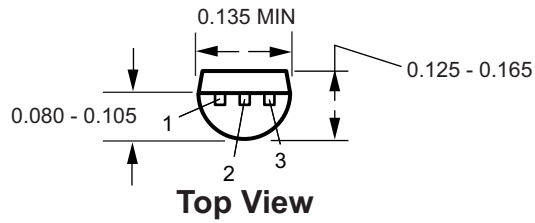

Notes:
 All dimensions are in millimeters; all angles in degrees.

3-Lead TO-243AA (SOT-89) Surface Mount Package (N8)

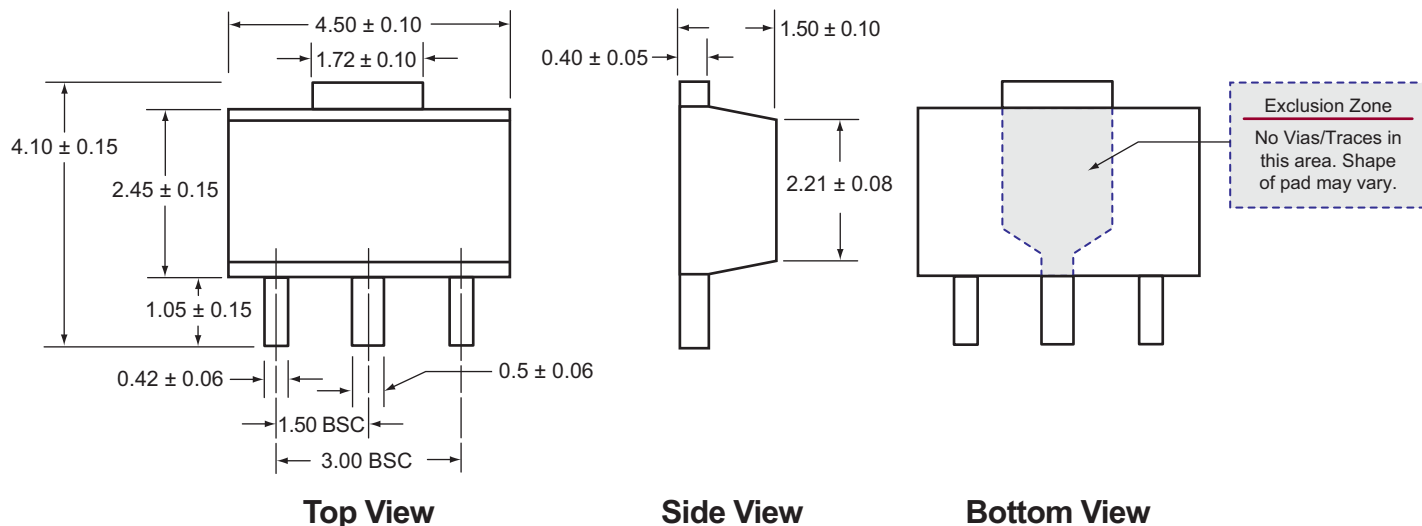

Notes:
 All dimensions are in millimeters; all angles in degrees.

(The package drawing(s) in this data sheet may not reflect the most current specifications. For the latest package outline information go to <http://www.supertex.com/packaging.html>.)

Supertex inc. does not recommend the use of its products in life support applications, and will not knowingly sell its products for use in such applications, unless it receives an adequate "product liability indemnification insurance agreement". **Supertex** does not assume responsibility for use of devices described and limits its liability to the replacement of the devices determined defective due to workmanship. No responsibility is assumed for possible omissions or inaccuracies. Circuitry and specifications are subject to change without notice. For the latest product specifications, refer to the **Supertex** website: <http://www.supertex.com>.

©2007 **Supertex inc.** All rights reserved. Unauthorized use or reproduction is prohibited.