

Four Character Smart Alphanumeric Displays

Technical Data

Features

- **Dot Matrix Replacement of HPDL-1414**
- **Smart Alphanumeric Display Built-in RAM, ASCII Decoder, and LED Drive Circuitry**
- **128 ASCII Character Set**
- **End Stackable**
- **Categorized for Luminous Intensity; Yellow and Green Categorized for Color**
- **Low Power and Sunlight Viewable AlGaAs Versions**
- **Wide Viewing Angle (50° Typical)**

Description

These are 3.7 mm (0.145 inch) four character 5 x 7 dot matrix displays driven by an on-board CMOS IC. These displays are pin for pin compatible with the HPDL-1414. The IC stores and decodes 7-bit ASCII data and displays it in an easy to read 5 x 7 font. Multiplexing and LED drive circuitry is also included in the display, and fast setup and hold times allow it to interface easily with common microprocessors.

The address and data inputs can be directly connected to microprocessor address and data buses.

The HDLX-1414 offers a larger character set than the HPDL-1414. Lower case letters and special symbols are now offered, made possible by the 5 x 7 dot matrix character layout.

HDLX-1414 Series

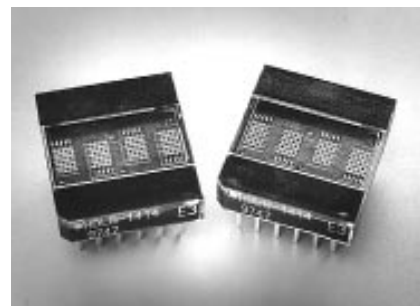

The difference between the sunlight viewable HDLS-1414 and the low power HDLU-1414 lies in the brightness level. The sunlight viewable version is internally set to provide high intensity characters. The low power version uses the same bright LED technology, but reduces the current through each LED to a much lower level, and maintains an intensity comparable to the HDLO-1414.

Devices

AlGaAs Red	High Efficiency Red	Orange	Yellow	Green
HDLS-1414 (sun. view.)	HDLO-1414	HDLA-1414	HDLY-1414	HDLG-1414
HDLU-1414 (low power)				

ESD Warning: Standard CMOS Handling Precautions should be observed with the HDLX-1414.

Package Dimensions

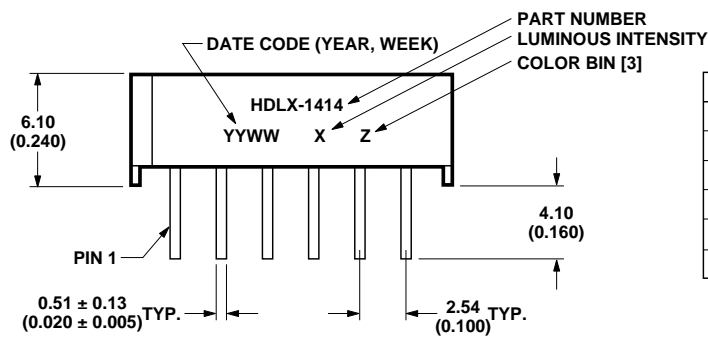
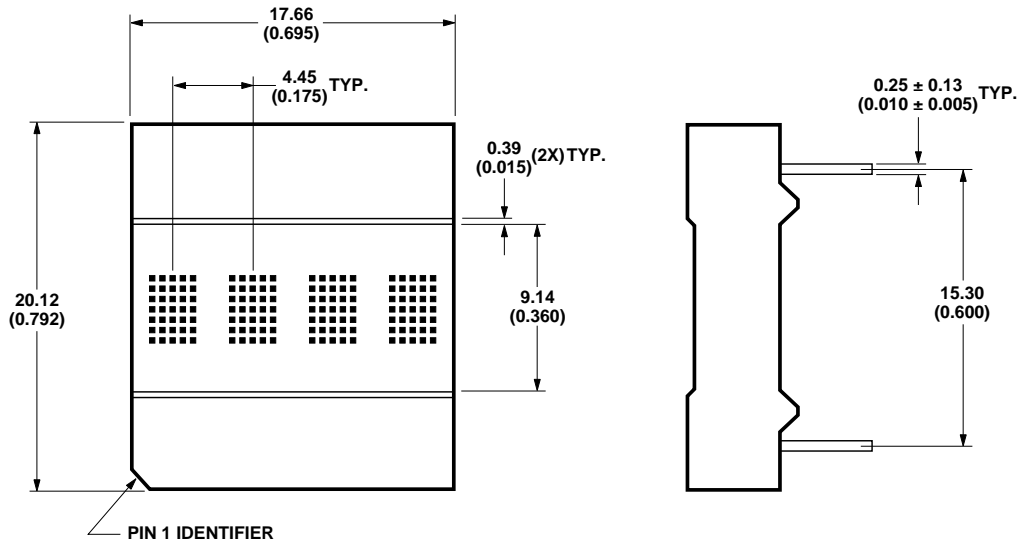

PIN NO.	FUNCTION	PIN NO.	FUNCTION
1	D ₅ DATA INPUT	7	GROUND
2	D ₄ DATA INPUT	8	D ₀ DATA INPUT
3	\WR WRITE	9	D ₁ DATA INPUT
4	A ₁ DIGIT SELECT	10	D ₂ DATA INPUT
5	A ₀ DIGIT SELECT	11	D ₃ DATA INPUT
6	V _{DD}	12	D ₆ DATA INPUT

DIMENSIONS ARE IN MILLIMETERS (INCHES).

Absolute Maximum Ratings

Supply Voltage, V _{DD} to Ground ^[1]	-0.5 V to 7.0 V
Input Voltage, Any Pin to Ground	-0.5 V to V _{DD} + 0.5 V
Free Air Operating Temperature Range, T _A	-40°C to +85°C
Storage Temperature, T _S	-40°C to +100°C
CMOS IC Junction Temperature	+150°C
Relative Humidity (non-condensing) at +65°C	85%
Maximum Solder Temperature, 1.59 mm (0.063 in.) below Seating Plane, t < 5 sec.	+260°C
ESD Classification, R = 1.5 kΩ, C = 100 pF	Class 1 (0 – 1999 V)

Note:

1. Maximum Voltage is with no LEDs illuminated.

Character Set

ASCII CODE				D0	0	1	0	1	0	1	0	1	0	1	0	1	0	1			
				D1	0	0	1	1	0	0	1	1	0	0	1	1	0	0	1	1	
				D2	0	0	0	0	1	1	1	1	1	0	0	0	0	1	1	1	1
				D3	0	0	0	0	0	0	0	0	0	1	1	1	1	1	1	1	1
D6	D5	D4	HEX	0	1	2	3	4	5	6	7	8	9	A	B	C	D	E	F		
0	0	0	0	!	@	A	B	C	D	E	F	G	H	I	J	K	L	M	N	O	
0	0	1	1	P	Q	R	S	T	U	V	W	X	Y	Z	[\]	^	_	`	
0	1	0	2		!	"	#	\$	%	&	'	()	*	+	,	-	.	/	`	
0	1	1	3	0	1	2	3	4	5	6	7	8	9	:	;	<	=	>	?	`	
1	0	0	4	a	b	c	d	e	f	g	h	i	j	k	l	m	n	o			
1	0	1	5	P	Q	R	S	T	U	V	W	X	Y	Z	[\]	^	_	`	
1	1	0	6	a	b	c	d	e	f	g	h	i	j	k	l	m	n	o			
1	1	1	7	P	Q	R	S	T	U	V	W	X	Y	Z	[\]	^	_	`	

NOTES: 1 = HIGH LEVEL
0 = LOW LEVEL

Recommended Operating Conditions

Parameter	Symbol	Min.	Typ.	Max.	Units
Supply Voltage	V_{DD}	4.5	5.0	5.5	V

Electrical/Optical Characteristics over Operating Temperature Range

4.5 < V_{DD} < 5.5 V (unless otherwise specified).

Parameter	Symbol	Min.	25°C ^[1]		Max.	Units	Test Conditions
			Typ.	Max.			
Blank Current	I_{DD} (blnk)		1.0		4.0	mA	All Digits Blanked
Input Current	I_I	-40			10	μ A	$V_{IN} = 0$ V to V_{DD} $V_{DD} = 5.0$ V
Input Voltage High	V_{IH}	2.0			V_{DD}	V	
Input Voltage Low	V_{IL}	GND			0.8	V	
I_{DD} 4 Digits 20 dots/character ^[2,3]	I_{DD} (#)		110	130	160	mA	"#" ON in all four locations

Notes:

- $V_{DD} = 5.0$ V.
- Average I_{DD} measured at full brightness. Peak $I_{DD} = 28/15 \times$ Average I_{DD} (#).
- I_{DD} (#) max. = 130 mA, 150°C IC junction temperature and $V_{DD} = 5.5$ V.

Optical Characteristics at 25°C^[1]

$V_{DD} = 5.0$ V at Full Brightness

AlGaAs Red HDLS-1414

Parameter	Symbol	Min.	Typ.	Units	Test Conditions
Average Luminous Intensity per digit, Character Average	I_V	4.0	12.7	mcd	"*" illuminated in all four digits. 19 dots ON per digit.
Peak Wavelength	λ_{PEAK}		645	nm	
Dominant Wavelength ^[2]	λ_D		637	nm	

AlGaAs Red HDLU-1414

Parameter	Symbol	Min.	Typ.	Units	Test Conditions
Average Luminous Intensity per digit, Character Average	I_V	1.2	3.1	mcd	"*" illuminated in all four digits. 19 dots ON per digit.
Peak Wavelength	λ_{PEAK}		645	nm	
Dominant Wavelength ^[2]	λ_D		637	nm	

High Efficiency Red HDLO-1414

Parameter	Symbol	Min.	Typ.	Units	Test Conditions
Average Luminous Intensity per digit, Character Average	I_V	1.2	3.5	mcd	"*" illuminated in all four digits. 19 dots ON per digit.
Peak Wavelength	λ_{PEAK}		635	nm	
Dominant Wavelength ^[2]	λ_D		626	nm	

Orange HDLA-1414

Parameter	Symbol	Min.	Typ.	Units	Test Conditions
Average Luminous Intensity per digit, Character Average	I_V	1.2	3.5	mcd	"*" illuminated in all four digits. 19 dots ON per digit.
Peak Wavelength	λ_{PEAK}		600	nm	
Dominant Wavelength ^[2]	λ_D		602	nm	

Yellow HDLY-1414

Parameter	Symbol	Min.	Typ.	Units	Test Conditions
Average Luminous Intensity per digit, Character Average	I_V	1.2	3.7	mcd	"*" illuminated in all four digits. 19 dots ON per digit.
Peak Wavelength	λ_{PEAK}		583	nm	
Dominant Wavelength ^[2]	λ_D		585	nm	

Green HDLG-1414

Parameter	Symbol	Min.	Typ.	Units	Test Conditions
Average Luminous Intensity per digit, Character Average	I_V	1.2	5.6	mcd	"*" illuminated in all four digits. 19 dots ON per digit.
Peak Wavelength	λ_{PEAK}		568	nm	
Dominant Wavelength ^[2]	λ_D		574	nm	

Notes:

1. Refers to the initial case temperature of the device immediately prior to the light measurement.
2. Dominant wavelength, λ_D , is derived from the CIE chromaticity diagram, and represents the single wavelength which defines the color of the device.

AC Timing Characteristics over Operating Temperature Range at $V_{DD} = 4.5\text{ V}$

Parameter	Symbol	Min.	Units
Address Setup	t_{AS}	10	ns
Address Hold	t_{AH}	40	ns
Data Setup	t_{DS}	50	ns
Data Hold	t_{DH}	40	ns
Chip Enable Setup	t_{CES}	0	ns
Chip Enable Hold	t_{CEH}	0	ns
Write Time	t_w	75	ns
Clear	t_{CLR}	10	μs
Clear Disable	$t_{CLR\text{D}}$	1	μs

Timing Diagram

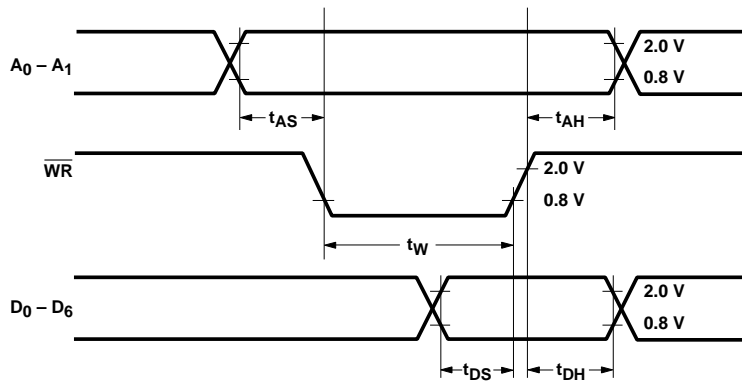

Enlarged Character Font

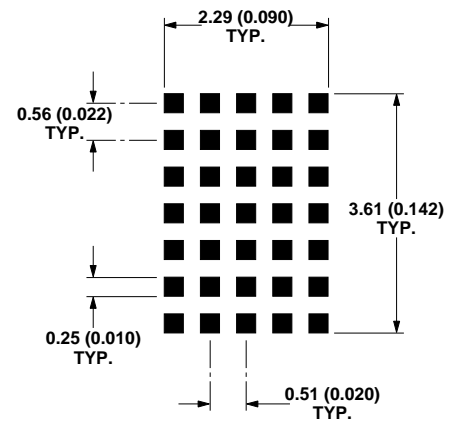

NOTES:

1. UNLESS OTHERWISE SPECIFIED, THE TOLERANCE ON ALL DIMENSIONS IS $\pm 0.254\text{ mm}$ (0.010").
2. DIMENSIONS ARE IN MILLIMETERS (INCHES).

Electrical Description

Pin Function	Description
\Write (WR, pin 3)	WR must be logic 0 to store data in the display.
Address Inputs (A ₁ and A ₀ , pins 4 and 5)	A ₀ and A ₁ select a specific location in the display memory. Address 00 accesses the far right character, and address 11 accesses the far left position.
V _{DD} (pin 6)	V _{DD} is the positive power supply input.
Ground (GND, pin 7)	Ground is the display ground.
Data Inputs (D ₀ –D ₆ , pins 1, 2, 8-12)	D ₀ –D ₆ are used to specify the input data for the display.

\WR	A ₁	A ₀	D ₆	D ₅	D ₄	D ₃	D ₂	D ₁	D ₀	Function
1	X	X	X	X	X	X	X	X	X	No Change
0	0	0	Digit 0 ASCII Data (Right Most Character)							Write to Character RAM
0	0	1	Digit 1 ASCII Data							
0	1	0	Digit 2 ASCII Data							
0	1	1	Digit 3 ASCII Data (Left Most Character)							

Figure 1. Display Truth Table

0 = Logic 0; 1 = Logic 1; X = Do Not Care.

Display Internal Block Diagram

Figure 2 shows the HDLX-1414 display internal block diagram. The CMOS IC consists of a 4 x 7 Character RAM, a 128-character ASCII decoder and the refresh circuitry necessary to synchronize the decoding and driving of four 5 x 7 dot matrix characters.

Four 7-bit ASCII words are stored in the Character RAM. The IC reads the ASCII data and decodes it via the 128-character ASCII decoder. This decoder includes the 64-character set of the HPDL-1414, 32 lower case ASCII symbols, and 32 foreign language symbols.

Data Entry

Figure 1 shows a truth table for the HDLX-1414 display. Address inputs A₀ and A₁ are used to select the digit location in the display. When A₀ and A₁ are both logic low, data is loaded into the right most character.

Data inputs D₀–D₆ are used to load information into the display. Data is latched into the given character address on the rising edge of the \WR signal. Data and Address inputs must be held stable during the write cycle to ensure that correct data is stored in the display.

Mechanical and Electrical Considerations

The HDLX-1414 is a 12-pin DIP package that can be stacked to create a character array of any size. The display is designed to operate reliably in –40°C to +85°C ambient temperatures.

The HDLX-1414 is assembled by die attaching and wire bonding 140 LEDs and a CMOS IC to a high temperature printed circuit board. A polycarbonate lens is placed over the PC board, creating a protective air gap over the LED wire bonds. Backfill epoxy environmentally seals the display package. This package construction makes the display highly tolerant to temperature cycling and allows wave soldering.

ESD and Latchup Protection

The inputs to the CMOS IC are protected against static discharge and input current latchup. However, for best results, standard CMOS handling precautions should be used. Prior to use, the HDLX-1414 should be stored in antistatic tubes or conductive material. During assembly a grounded conductive work area should be used, and assembly personnel should wear conductive wrist straps. Lab coats made of synthetic material should be avoided since they are prone to static charge build-up. Input current latchup can be caused when the CMOS inputs are subjected either to a voltage below ground ($V_{in} < \text{ground}$) or higher than V_{DD} ($V_{in} > V_{DD}$) and when a high current is forced into the input. To prevent input current latchup and ESD damage, unused inputs should be connected either to ground or to V_{DD}. Voltages should not be

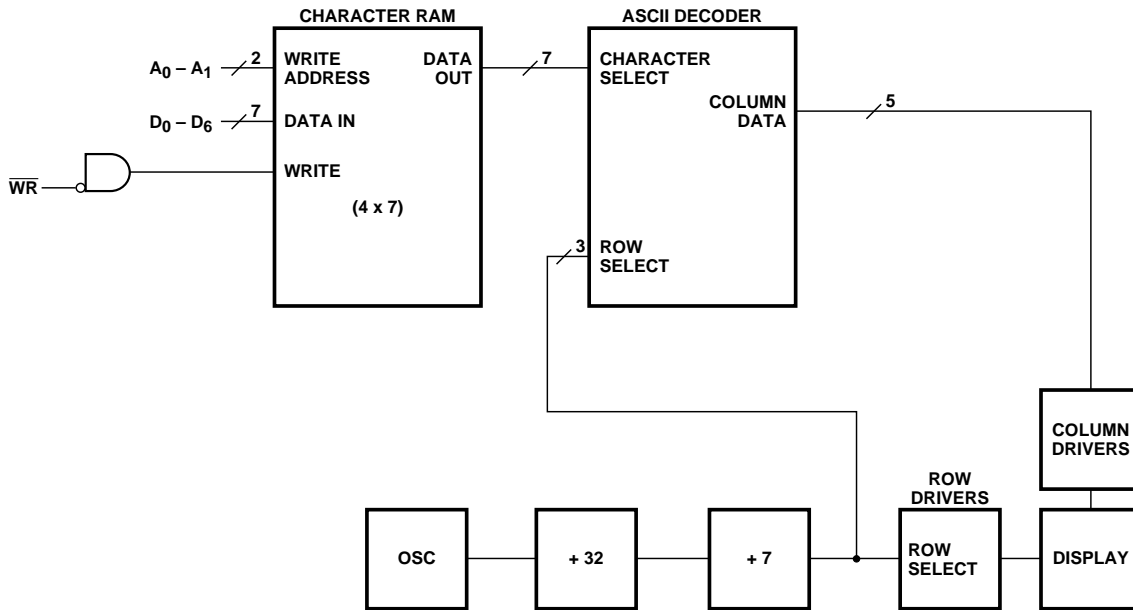
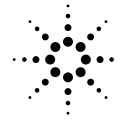

Figure 2. Display Internal Block Diagram.

applied to the inputs until V_{DD} has been turned on, and high transient input voltages should be eliminated.

Soldering Instructions

The HDLX-1414 is compatible with hand- and wave-solder processes. The use of a no-clean flux is recommended.

The polycarbonate lens on these displays is incompatible with some fluxes and cleaning solutions. It is not recommended for use with heated Terpene, or solutions of propylene glycol monomethyl ether and monoethanolamine.

For further information on soldering and post-solder cleaning, see Application Note 1027, *Soldering LED Components*.

Contrast Enhancement

The objective of contrast enhancement is to provide good readability in the end user's ambient lighting conditions. By using both luminance (brightness) and chrominance (color) contrast techniques, the ON dots of the display can be made to stand out against a dark background.

For further information on contrast enhancement, see Application Note 1015, *Contrast Enhancement Techniques for LED Displays*.