

# NPN Phototransistor with Base-Emitter Resistor Types OP755A, OP755B, OP755C, OP755D

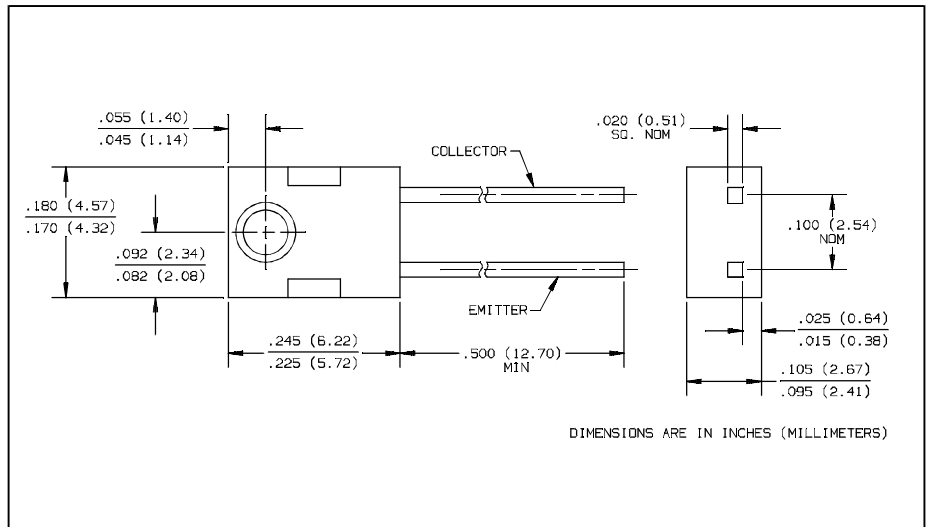
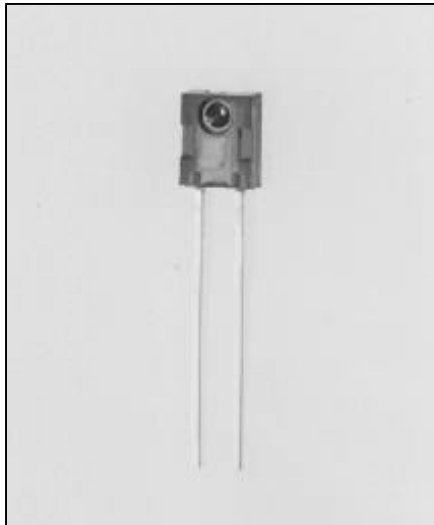

## Features

- Wide receiving angle
- Variety of sensitivity ranges
- Side-looking package for space limited applications
- Base-emitter resistor provides ambient light protection

## Description

The OP755 device consists of a NPN silicon phototransistor molded in blue tinted epoxy packages. The wide receiving angle provides relatively even reception over a large area. The side-looking package is designed for easy PC board mounting of slotted optical switches or optical interrupt detectors. The series is mechanically and spectrally matched to the OP140 and OP240 series of infrared emitting diodes.

The phototransistor has an internal base-emitter resistor which provides protection from low level ambient lighting conditions. This feature is also useful when the media being detected is semi-transparent to infrared light in interruptive applications.

## Absolute Maximum Ratings ( $T_A = 25^\circ\text{C}$ unless otherwise noted)

Collector-Emitter Voltage	30 V
Emitter Reverse Current	10 mA
Collector DC Current	30 mA
Storage and Operating Temperature Range	$-40^\circ\text{C}$ to $+100^\circ\text{C}$
Lead Soldering Temperature [1/16 inch (1.6 mm) from case for 5 sec. with soldering iron]	$260^\circ\text{C}^{(1)}$
Power Dissipation	$200\text{ mW}^{(2)}$

### Notes:

- (1) RMA flux is recommended. Duration can be extended to 10 sec. max. When flow soldering. Max. 20 grams force may be applied to leads when soldering.
- (2) Derate linearly  $2.0\text{ mW}/^\circ\text{C}$  above  $25^\circ\text{C}$ .
- (3) Light source is an unfiltered GaAs LED with a peak emission wavelength of 935 nm and a radiometric intensity level which varies less than 10% over the entire lens surface of the phototransistor being tested.
- (4) The knee point irradiance is defined as the irradiance required to increase  $I_{C(ON)}$  to 50 mA.

## Typical Performance Curves

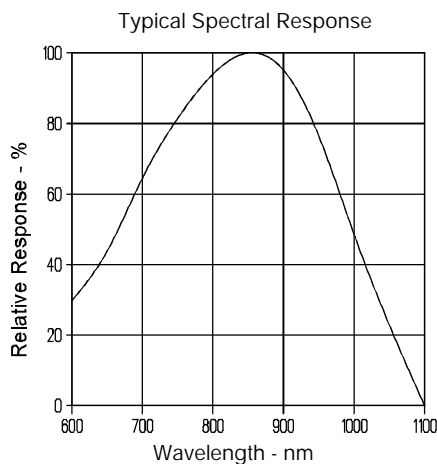

## Schematic

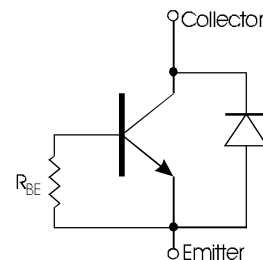

# Types OP755A, OP755B, OP755C, OP755D

Electrical Characteristics ( $T_A = 25^\circ\text{C}$  unless otherwise noted)

SYMBOL	PARAMETER	MIN	TYP	MAX	UNITS	TEST CONDITIONS
$I_{C(ON)}$	On-State Collector Current	OP755A	1.80	5.50	mA	$V_{CE} = 5\text{ V}$ , $E_e = 1.0\text{ mW/cm}^2(3)$
		OP755B	1.20	3.40		
		OP755C	0.70	2.25		
		OP755D	0.70	5.50		
$E_{KP}$	Knee Point Irradiance		.2		$\text{mW/cm}^2$	$V_{CE} = 5\text{ V}(4)$
$I_{CEO}$	Collector-Emitter Dark Current			100	nA	$V_{CE} = 10\text{ V}$ , $E_e = 0$
$I_{ECO}$	Emitter-Reverse Current			100	mA	$V_{CE} = 0.4\text{ V}$
$V_{(BR)CEO}$	Collector-Emitter Breakdown	30			V	$I_C = 100\text{ mA}$
$V_{CE(SAT)}$	Collector-Emitter Saturation Voltage			0.4	V	$I_C = 100\text{ mA}$ , $E_e = 1\text{ mW/cm}^2(3)$

## Typical Performance Curves

Normalized Collector Current vs. Angular Displacement

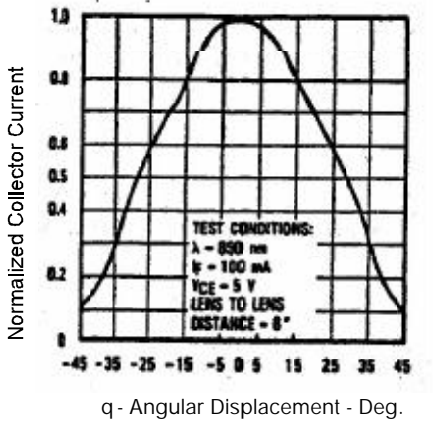

Normalized Light and Dark Current vs. Ambient Temperature

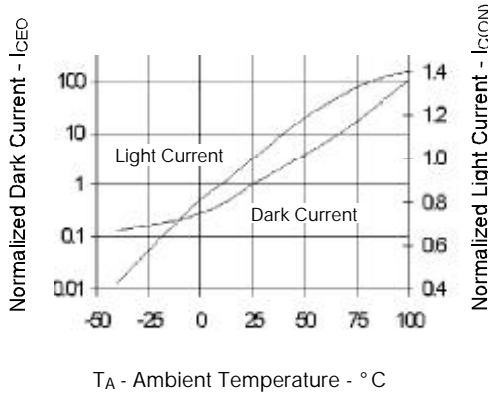

On-State Collector Current vs. Irradiance

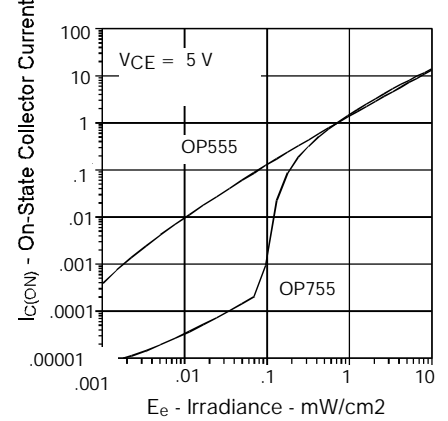

Normalized Output vs. Frequency

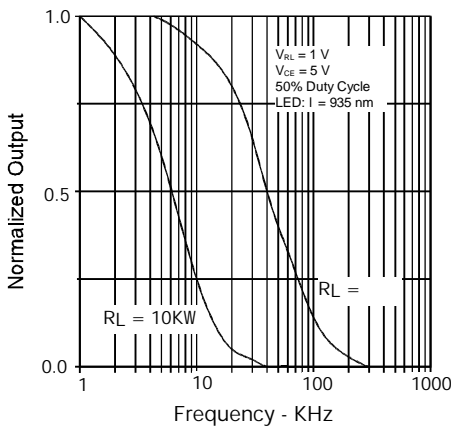

Typical Rise and Fall Time vs. Load Resistance

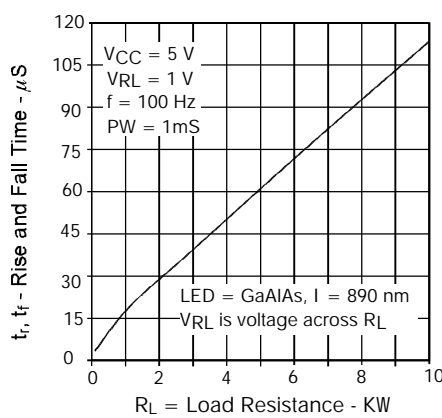

Switching Time Test Circuit

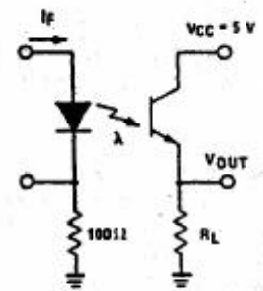

Test Conditions:  
Light source is pulsed LED with  $t_r$  and  $t_f \leq 500\text{ ns}$ .  
 $I_f$  is adjusted for  $V_{OUT} = 1\text{ Volt}$ .

Optek reserves the right to make changes at any time in order to improve design and to supply the best product possible.

Optek Technology, Inc. 1215 W. Crosby Road Carrollton, Texas 75006 (972)323-2200 Fax (972)323-2396