

2SK932

T-31-25



2050

N-Channel Junction Silicon FET

High-Frequency Low-Noise Amp Applications

©2841

Applications

- AM tuner RF amp, low-noise amp

Features

- Adoption of FBET process
- Large $|y_{fs}|$
- Small c_{iss}
- Very low noise figure
- Very small-sized package permitting 2SK932-applied sets to be made smaller and slimmer



Absolute Maximum Ratings at $T_a = 25^\circ\text{C}$

			unit
Drain to Source Voltage	V_{DSX}	15	V
Gate to Drain Voltage	V_{GDS}	-15	V
Gate Current	I_G	10	mA
Drain Current	I_D	50	mA
Allowable Power Dissipation	P_D	200	mW
Junction Temperature	T_j	150	$^\circ\text{C}$
Storage Temperature	T_{stg}	-55 to +150	$^\circ\text{C}$

Electrical Characteristics at $T_a = 25^\circ\text{C}$

			min	typ	max	unit
Gate to Drain Breakdown Voltage	$V_{(BR)GDS}$	$I_G = -10\mu\text{A}, V_{DS} = 0\text{V}$	-15			V
Gate Cutoff Current	I_{GSS}	$V_{GS} = -10\text{V}, V_{DS} = 0\text{V}$			-1.0	nA
Cutoff Voltage	$V_{GS(off)}$	$V_{DS} = 5\text{V}, I_D = 100\mu\text{A}$	-0.2	-0.6	-1.4	V
Drain Current	I_{DSS}	$V_{DS} = 5\text{V}, V_{GS} = 0\text{V}$	※5.0		※24.0	mA
Forward Transfer Admittance	$ y_{fs} $	$V_{DS} = 5\text{V}, V_{GS} = 0\text{V}, f = 1\text{kHz}$	25	50		mS
Input Capacitance	c_{iss}	$V_{DS} = 5\text{V}, V_{GS} = 0\text{V}, f = 1\text{MHz}$		10		pF
Reverse Transfer Capacitance	c_{rss}	$V_{DS} = 5\text{V}, V_{GS} = 0\text{V}, f = 1\text{MHz}$		3.0		pF
Noise Figure	NF	$V_{DS} = 5\text{V}, R_g = 1\text{k}\Omega, I_D = 1\text{mA}, f = 1\text{kHz}$	1.5			dB

※ : The 2SK932 is classified by I_{DSS} as follows (unit : mA) :

5.0	21	8.5	7.3	22	12.0	10.0	23	17.0	14.5	24	24.0
-----	----	-----	-----	----	------	------	----	------	------	----	------

(Note) Marking : E
 I_{DSS} rank : 21,22,23,24

Case Outline 2050 (unit : mm)

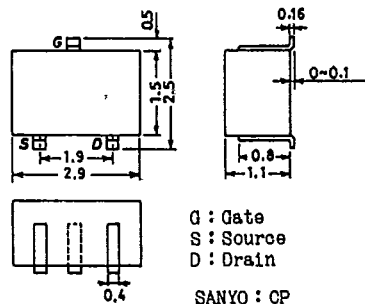

2SK932

T-31-25

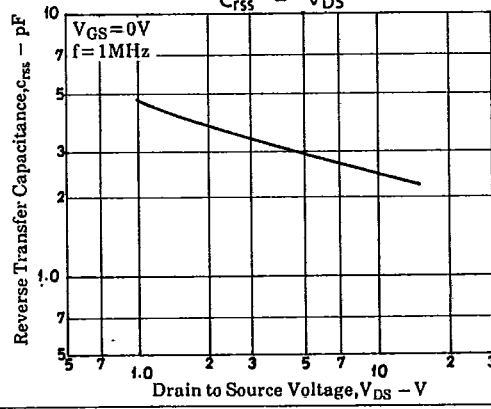
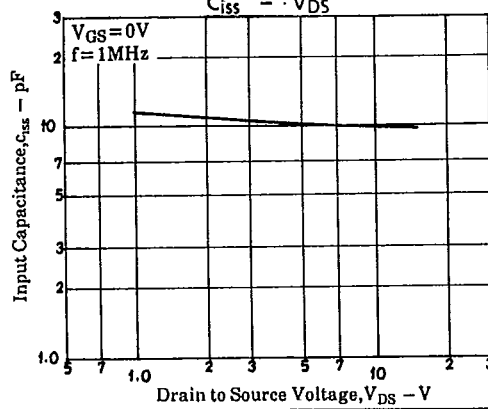
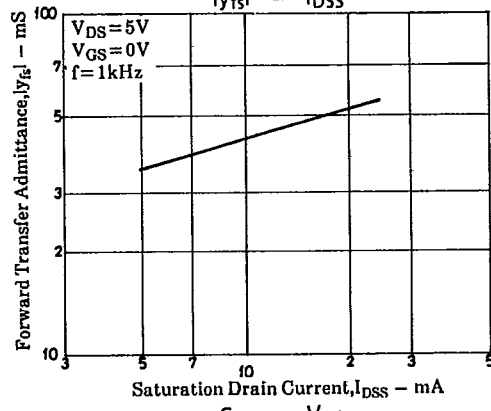
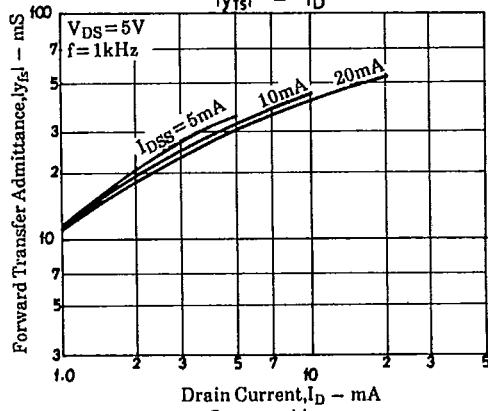
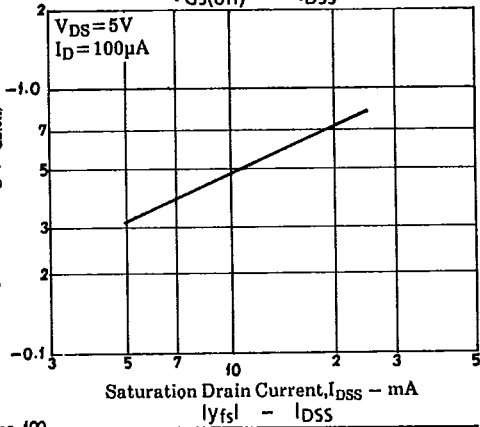
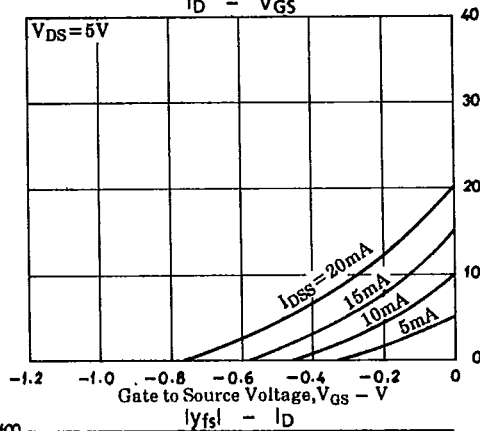
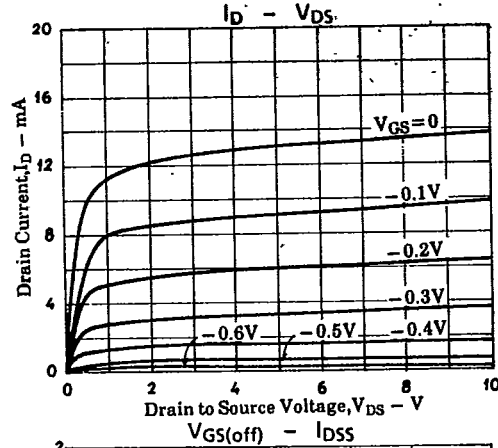
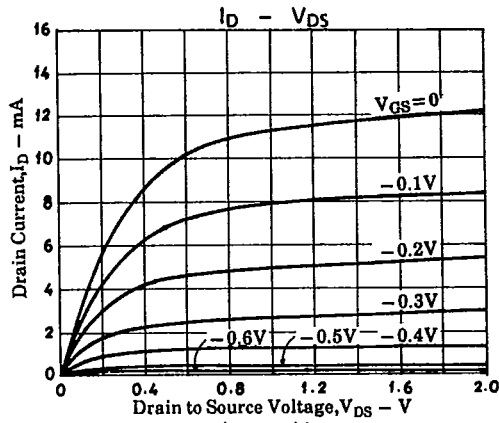

2SK932

T-31-25

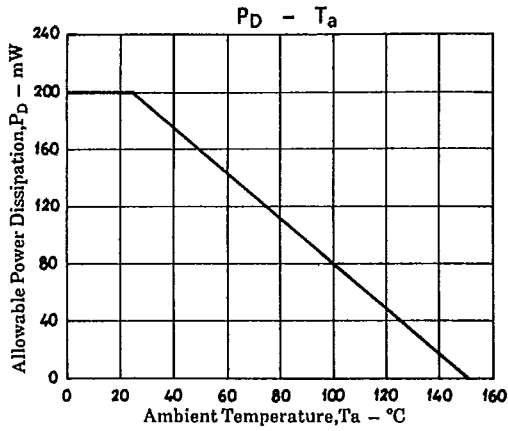
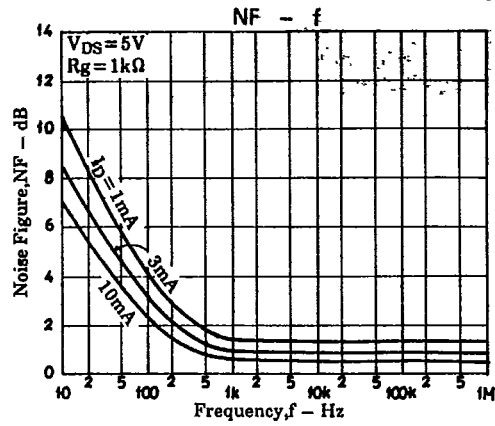
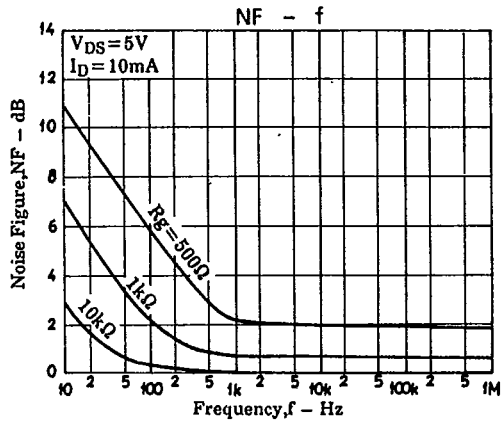

T-91-20

CASE OUTLINES OF SURFACE MOUNT TRANSISTORS

- All of Sanyo surface mount transistor case outlines are illustrated below.
- All dimensions are in mm, and dimensions which are not followed by min. or max. are represented by typical values.
- No marking is indicated.

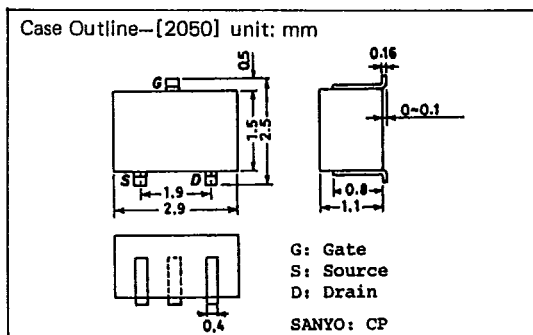
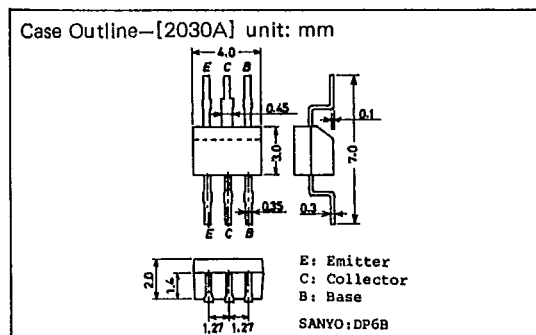
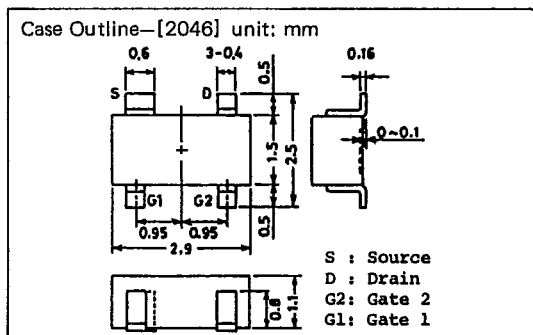
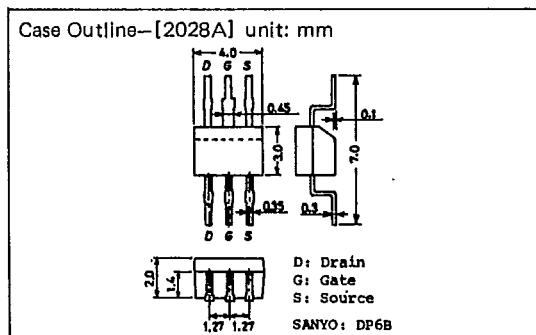
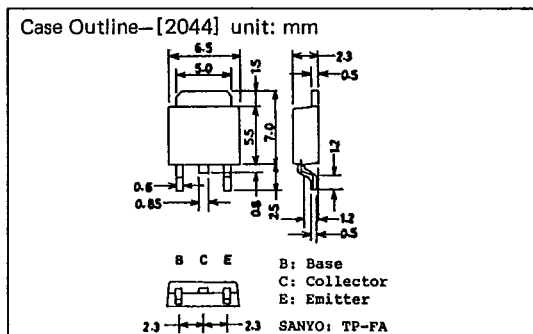
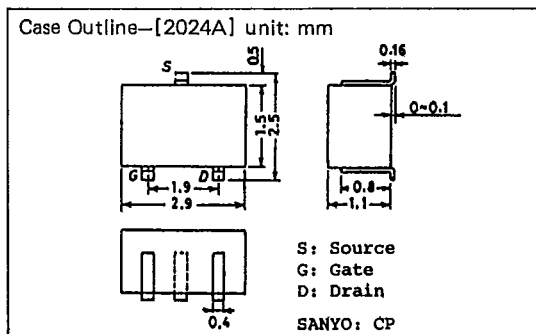
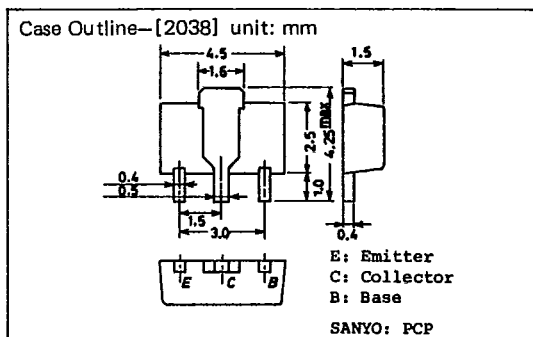
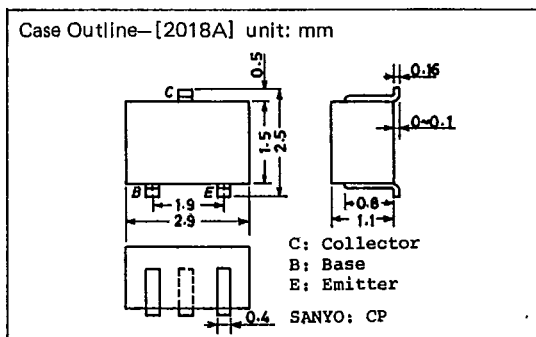

T-91-20

Case Outline—[2057] unit: mm

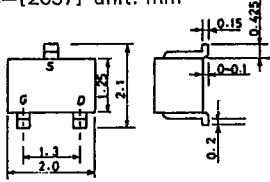

S: Source
G: Gate
D: Drain
SANYO: MCP

Case Outline—[2066] unit: mm

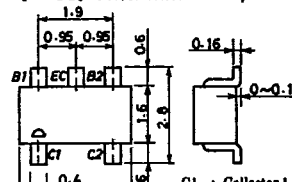

C1 : Collector 1
C2 : Collector 2
B2 : Base 2
EC : Emitter Common
B1 : Base 1
SANYO : CP6

Case Outline—[2058] unit: mm

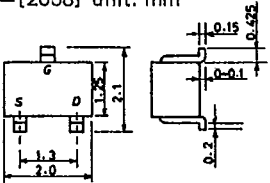

G: Gate
S: Source
D: Drain
SANYO: MCP

Case Outline—[2067] unit: mm

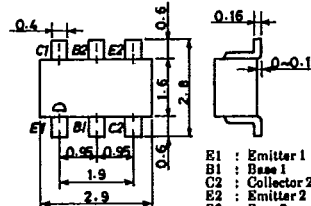

E1 : Emitter 1
B1 : Base 1
C2 : Collector 2
E2 : Emitter 2
B2 : Base 2
C1 : Collector 1
SANYO : CP6

Case Outline—[2059] unit: mm

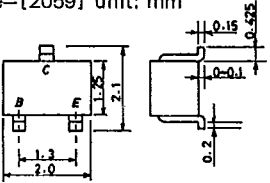

B: Base
C: Collector
E: Emitter
SANYO: MCP

Case Outline—[2068] unit: mm

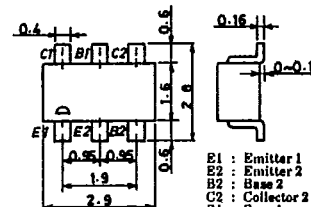

B1 : Emitter 1
E2 : Emitter 2
B2 : Base 2
C2 : Collector 2
B1 : Base 1
C1 : Collector 1
SANYO : CP6

Case Outline—[2062] unit: mm

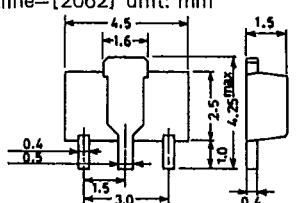

S: Source
D: Drain
G: Gate
SANYO: PCP

Case Outline—[2069] unit: mm

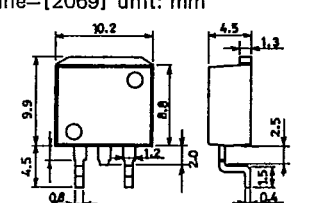

B: Base
C: Collector
E: Emitter
SANYO: SMP

Case Outline—[2065] unit: mm

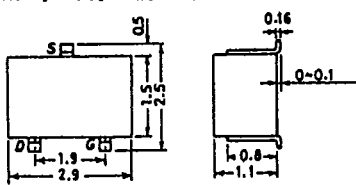

S: Source
D: Drain
G: Gate
SANYO: CP

Case Outline—[2070] unit: mm

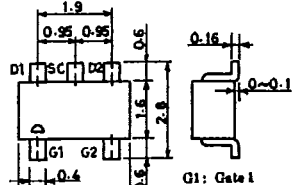

G1 : Gate 1
G2 : Gate 2
D2 : Drain 2
SC : Source Common
D1 : Drain 1
SANYO : CP6

T-9120

