

Thyristor Modules

Thyristor/Diode Modules

$$I_{TRMS} = 2 \times 400 \text{ A}$$

$$I_{TAVM} = 2 \times 250 \text{ A}$$

$$V_{RRM} = 800-1800 \text{ V}$$

V_{RSM} V_{DSM} V	V_{RRM} V_{DRM} V	Type	Version 1	Version 1
900	800	MCC 220-08io1	MCD 220-08io1	
1300	1200	MCC 220-12io1	MCD 220-12io1	
1500	1400	MCC 220-14io1	MCD 220-14io1	
1700	1600	MCC 220-16io1	MCD 220-16io1	
1900	1800	MCC 220-18io1	MCD 220-18io1	

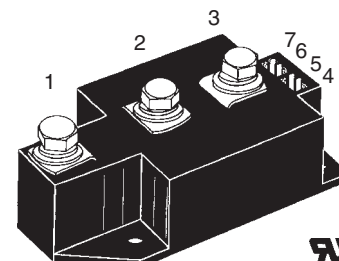

Symbol	Conditions	Maximum Ratings	
I_{TRMS}, I_{FRMS} I_{TAVM}, I_{FAVM}	$T_{VJ} = T_{VJM}$ $T_C = 85^\circ\text{C}; 180^\circ \text{ sine}$	400	A
		250	A
I_{TSM}, I_{FSM}	$T_{VJ} = 45^\circ\text{C}$ $V_R = 0$	$t = 10 \text{ ms (50 Hz), sine}$ $t = 8.3 \text{ ms (60 Hz), sine}$	8500 A 9000 A
	$T_{VJ} = T_{VJM}$ $V_R = 0$	$t = 10 \text{ ms (50 Hz), sine}$ $t = 8.3 \text{ ms (60 Hz), sine}$	7000 A 7600 A
$\int i^2 dt$	$T_{VJ} = 45^\circ\text{C}$ $V_R = 0$	$t = 10 \text{ ms (50 Hz), sine}$ $t = 8.3 \text{ ms (60 Hz), sine}$	360000 A ² s 336000 A ² s
	$T_{VJ} = T_{VJM}$ $V_R = 0$	$t = 10 \text{ ms (50 Hz), sine}$ $t = 8.3 \text{ ms (60 Hz), sine}$	245000 A ² s 240000 A ² s
$(di/dt)_{cr}$	$T_{VJ} = T_{VJM};$ $f = 50 \text{ Hz}; t_p = 200 \mu\text{s}$ $V_D = \frac{2}{3} V_{DRM}$	repetitive, $I_T = 750 \text{ A}$	100 A/ μs
	$I_G = 1 \text{ A}$ $di_G/dt = 1 \text{ A}/\mu\text{s}$	non repetitive, $I_T = 250 \text{ A}$	800 A/ μs
$(dv/dt)_{cr}$	$T_{VJ} = T_{VJM};$ $R_{GK} = \infty;$ method 1 (linear voltage rise)	$V_{DR} = \frac{2}{3} V_{DRM}$	1000 V/ μs
P_{GM}	$T_{VJ} = T_{VJM};$ $I_T = I_{TAVM};$	$t_p = 30 \mu\text{s}$ $t_p = 500 \mu\text{s}$	120 W 60 W
P_{GAV}			20 W
V_{RGM}			10 V
T_{VJ}			-40...+140 °C
T_{VJM}			140 °C
T_{stg}			-40...+125 °C
V_{ISOL}	50/60 Hz, RMS; $I_{ISOL} \leq 1 \text{ mA};$	$t = 1 \text{ min}$ $t = 1 \text{ s}$	3000 V~ 3600 V~
M_d	Mounting torque (M5) Terminal connection torque (M8)		2.5-5/22-44 Nm/lb.in. 12-15/106-132 Nm/lb.in.
Weight	Typical including screws		320 g

Data according to IEC 60747 and refer to a single thyristor/diode unless otherwise stated.
IXYS reserves the right to change limits, test conditions and dimensions

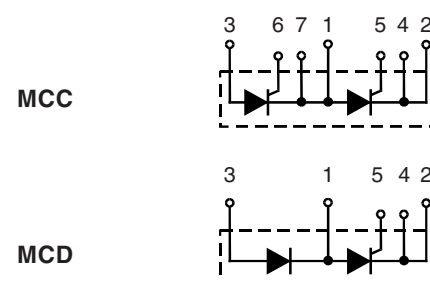

Features

- International standard package
- Direct copper bonded Al_2O_3 -ceramic base plate
- Planar passivated chips
- Isolation voltage 3600 V~
- UL registered, E 72873
- Keyed gate/cathode twin pins

Applications

- Motor control
- Power converter
- Heat and temperature control for industrial furnaces and chemical processes
- Lighting control
- Contactless switches

Advantages

- Space and weight savings
- Simple mounting
- Improved temperature and power cycling
- Reduced protection circuits

Symbol	Conditions	Characteristic Values
I_{RRM}	$T_{VJ} = T_{VJM}; V_R = V_{RRM}; V_D = V_{DRM}$	70 mA
I_{DRM}		40 mA
V_T, V_F	$I_T/I_F = 600 A; T_{VJ} = 25^\circ C$	1.53 V
V_{T0}	For power-loss calculations only ($T_{VJ} = 140^\circ C$)	0.9 V
r_T		1.0 m Ω
V_{GT}	$V_D = 6 V; T_{VJ} = 25^\circ C$	2 V
	$T_{VJ} = -40^\circ C$	3 V
I_{GT}	$V_D = 6 V; T_{VJ} = 25^\circ C$	150 mA
	$T_{VJ} = -40^\circ C$	200 mA
V_{GD}	$T_{VJ} = T_{VJM}; V_D = \frac{2}{3} V_{DRM}$	0.25 V
I_{GD}		10 mA
I_L	$T_{VJ} = 25^\circ C; t_p = 30 \mu s; V_D = 6 V$ $I_G = 0.45 A; di_G/dt = 0.45 A/\mu s$	200 mA
I_H	$T_{VJ} = 25^\circ C; V_D = 6 V; R_{GK} = \infty$	150 mA
t_{gd}	$T_{VJ} = 25^\circ C; V_D = \frac{1}{2} V_{DRM}$ $I_G = 1 A; di_G/dt = 1 A/\mu s$	2 μs
t_q	$T_{VJ} = T_{VJM}; I_T = 300 A, t_p = 200 \mu s; -di/dt = 10 A/\mu s$ $V_R = 100 V; dv/dt = 50 V/\mu s; V_D = \frac{2}{3} V_{DRM}$	typ. 200 μs
Q_S	$T_{VJ} = 125^\circ C; I_T, I_F = 400 A, -di/dt = 50 A/\mu s$	760 μC
I_{RM}		275 A
R_{thJC}	per thyristor/diode; DC current per module	0.139 KW
R_{thJK}	per thyristor/diode; DC current per module	0.0695 KW
	other values see Fig. 8/9	0.179 KW
		0.0895 KW
d_s	Creepage distance on surface	12.7 mm
d_A	Strike distance through air	9.6 mm
a	Maximum allowable acceleration	50 m/s ²

Optional accessories for modules

Keyed gate/cathode twin plugs with wire length = 350 mm, gate = yellow, cathode = red

Type ZY 180L (L = Left for pin pair 4/5) } UL 758, style 1385,

Type ZY 180R (R = right for pin pair 6/7) } CSA class 5851, guide 460-1-1

Dimensions in mm (1 mm = 0.0394")

MCC

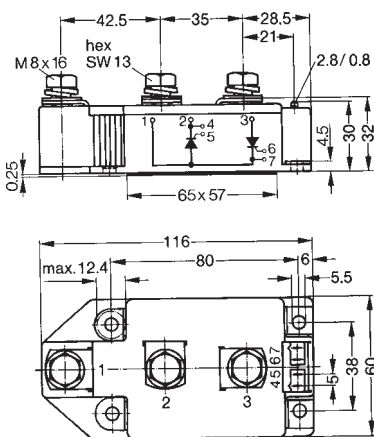

MCD

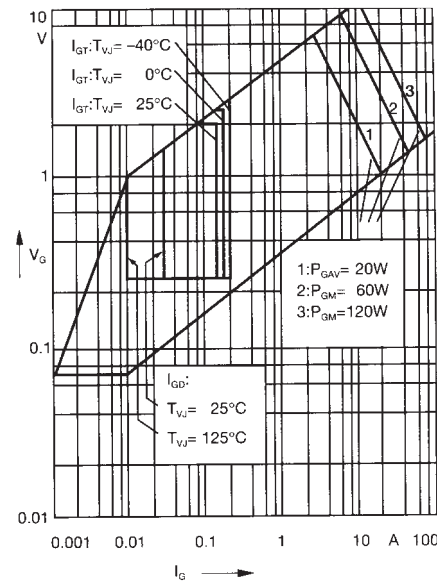
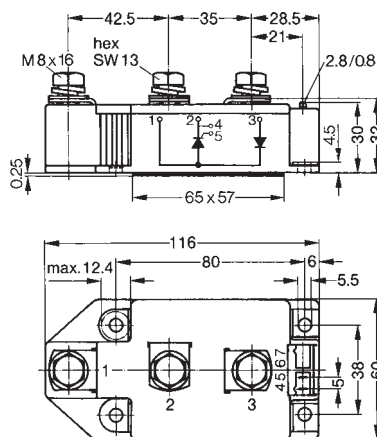

Fig. 1 Gate trigger characteristics

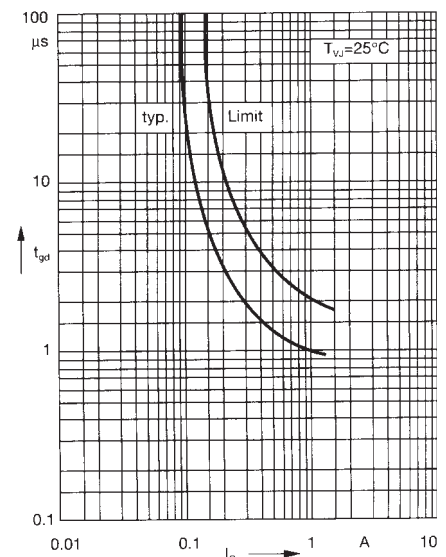
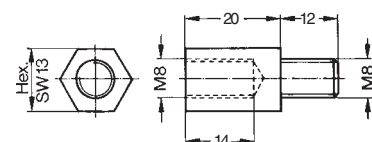

Fig. 2 Gate trigger delay time

Threaded spacer for higher Anode/
Cathode construction:

Type ZY 250, material brass



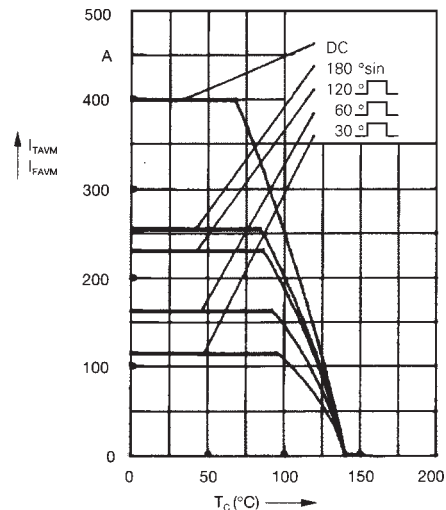
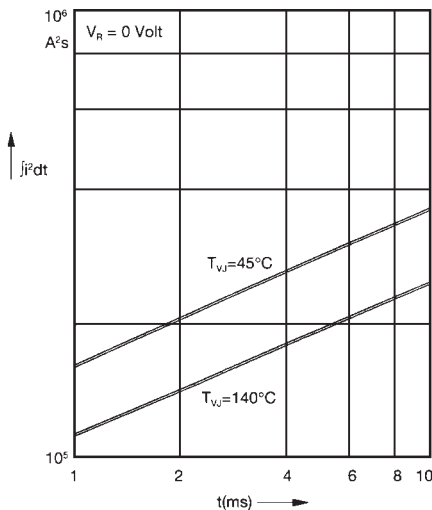
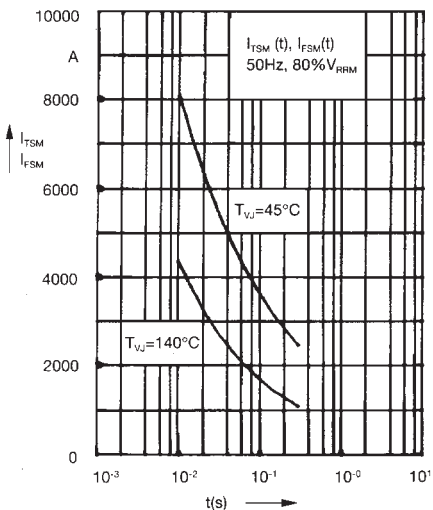

Fig. 3 Surge overload current
 I_{TSM}, I_{FSM} : Crest value, t: duration

Fig. 4 $\int i^2 dt$ versus time (1-10 ms)

Fig. 4a Maximum forward current at case temperature

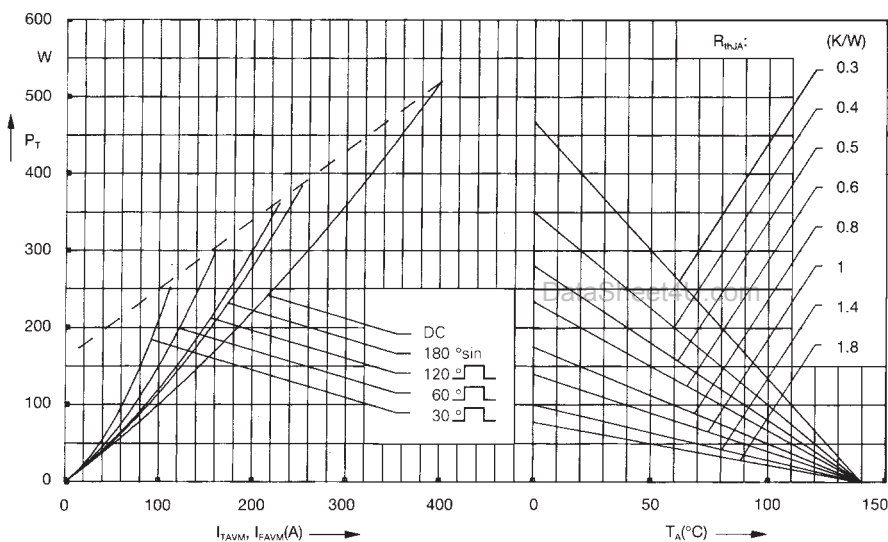

Fig. 5 Power dissipation versus on-state current and ambient temperature (per thyristor or diode)

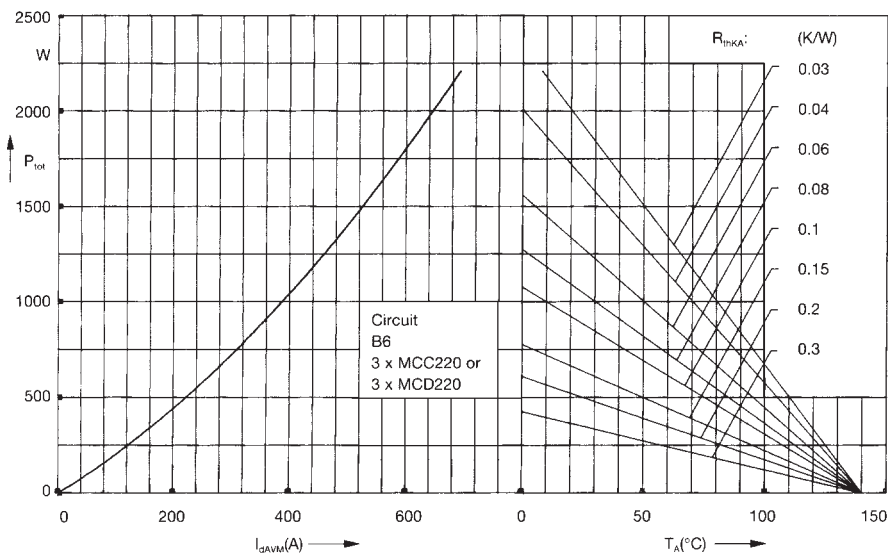

Fig. 6 Three phase rectifier bridge: Power dissipation versus direct output current and ambient temperature

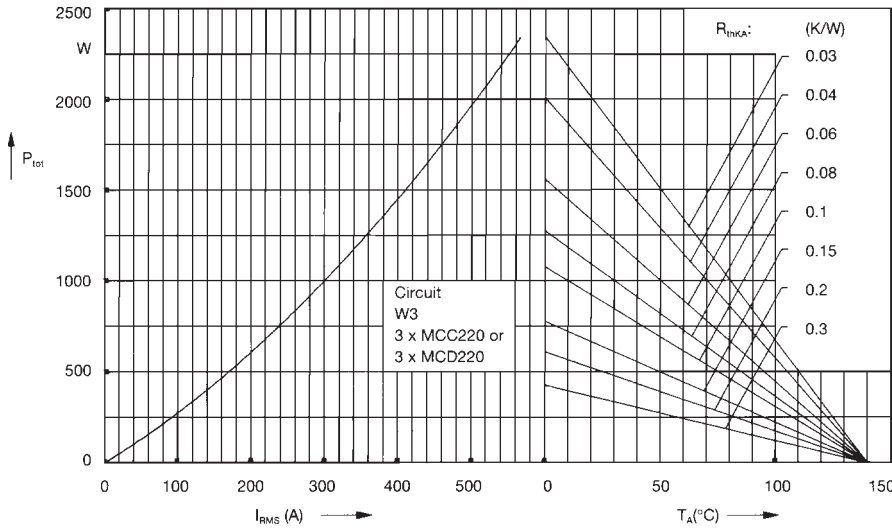

Fig. 7 Three phase AC-controller: Power dissipation versus RMS output current and ambient temperature

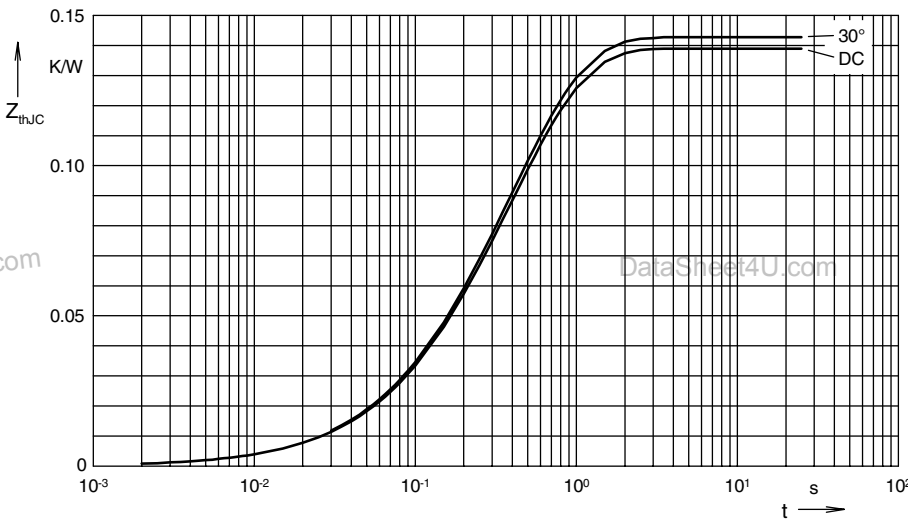

Fig. 8 Transient thermal impedance junction to case (per thyristor or diode)

R_{thjC} for various conduction angles d :

d	R_{thjC} (K/W)
DC	0.139
180°C	0.141
120°C	0.142
60°C	0.142
30°C	0.143

Constants for Z_{thjC} calculation:

i	R_{thi} (K/W)	t_i (s)
1	0.0037	0.0099
2	0.0177	0.168
3	0.1175	0.456

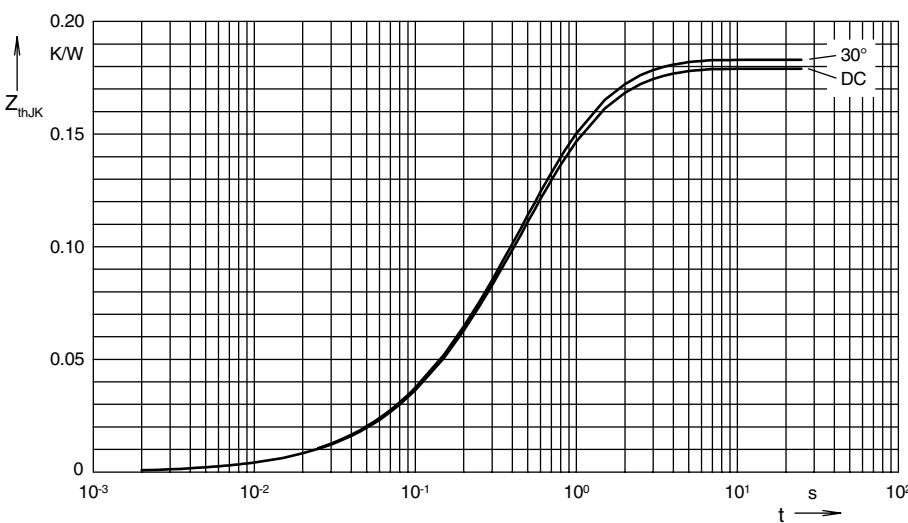

Fig. 9 Transient thermal impedance junction to heatsink (per thyristor or diode)

R_{thjK} for various conduction angles d :

d	R_{thjK} (K/W)
DC	0.179
180°C	0.181
120°C	0.182
60°C	0.183
30°C	0.183

Constants for Z_{thjK} calculation:

i	R_{thi} (K/W)	t_i (s)
1	0.0037	0.0099
2	0.0177	0.168
3	0.1175	0.456
4	0.04	1.36