

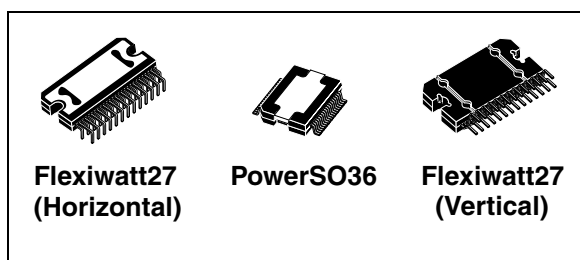


TDA7563B

4 x 50W multifunction quad power amplifier
with built-in diagnostics feature

Features

- Multipower BCD technology
- MOSFET output power stage
- DMOS power output
- New Hi-efficiency (class SB)
- High output power capability 4x28W/4Ω @ 14.4V, 1KHZ, 10% THD, 4x50W max, power
- Max. output power 4x72W/2Ω
- Full I²C bus driving:
 - St-by
 - Independent front/rear soft play/mute
 - Selectable gain 30dB /16dB (for low noise line output function)
 - High efficiency enable/disable
 - I²C bus digital diagnostics (including DC bus AC load detection)
- Full fault protection
- DC offset detection
- Four independent short circuit protection
- Clipping detector pin with selectable threshold (2%/10%)
- St-by/mute pin
- Linear thermal shutdown with multiple thermal warning
- ESD protection



Description

The TDA7563B is a new BCD technology Quad Bridge type of car radio amplifier in Flexiwatt27 package specially intended for car radio applications.

Thanks to the DMOS output stage the TDA7563B has a very low distortion allowing a clear powerful sound. Among the features, its superior efficiency performance coming from the internal exclusive structure, makes it the most suitable device to simplify the thermal management in high power sets.

The dissipated output power under average listening condition is in fact reduced up to 50% when compared to the level provided by conventional class AB solutions.

This device is equipped with a full diagnostics array that communicates the status of each speaker through the I²C bus.

Order codes

| Part number | Package | Packing |
|--------------|--------------------------|-------------|
| TDA7563B | Flexiwatt27 (vertical) | Tube |
| TDA7563BH | Flexiwatt27 (horizontal) | Tube |
| TDA7563BPD | PowerSO36 | Tube |
| TDA7563BPDTR | PowerSO36 | Tape & reel |

Contents

| | | |
|----------|--|-----------|
| 1 | Block diagrams and application circuit | 4 |
| 2 | Pins description | 5 |
| 3 | Electrical specifications | 6 |
| 3.1 | Absolute maximum ratings | 6 |
| 3.2 | Thermal data | 6 |
| 3.3 | Electrical characteristics | 6 |
| 3.4 | Electrical characteristics curves | 9 |
| 4 | Diagnostics functional description | 12 |
| 4.1 | Turn-on diagnostic | 12 |
| 4.2 | Permanent diagnostics | 14 |
| 4.3 | Output DC offset detection | 15 |
| 4.4 | AC diagnostic | 15 |
| 5 | Multiple faults | 17 |
| 5.1 | Faults availability | 17 |
| 6 | Thermal protection | 18 |
| 6.1 | Fast muting | 18 |
| 7 | I²C Bus | 19 |
| 7.1 | I ² C Programming/reading sequences | 19 |
| 7.2 | I2C Bus interface | 19 |
| 7.2.1 | Data Validity | 19 |
| 7.2.2 | Start and Stop Conditions | 19 |
| 7.2.3 | Byte Format | 19 |
| 7.2.4 | Acknowledge | 19 |
| 8 | Software specifications | 21 |
| 9 | Examples of bytes sequence | 25 |

| | | |
|-----------|----------------------------------|-----------|
| 10 | Package information | 26 |
| 11 | Revision history | 29 |

1 Block diagrams and application circuit

Figure 1. Block diagram

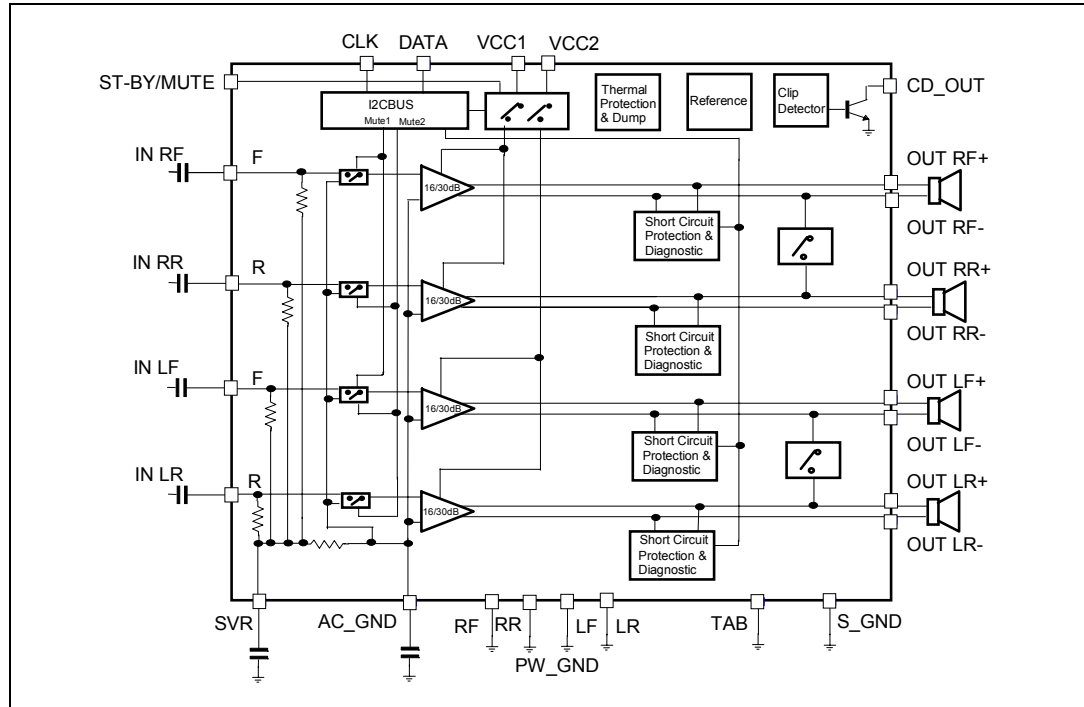
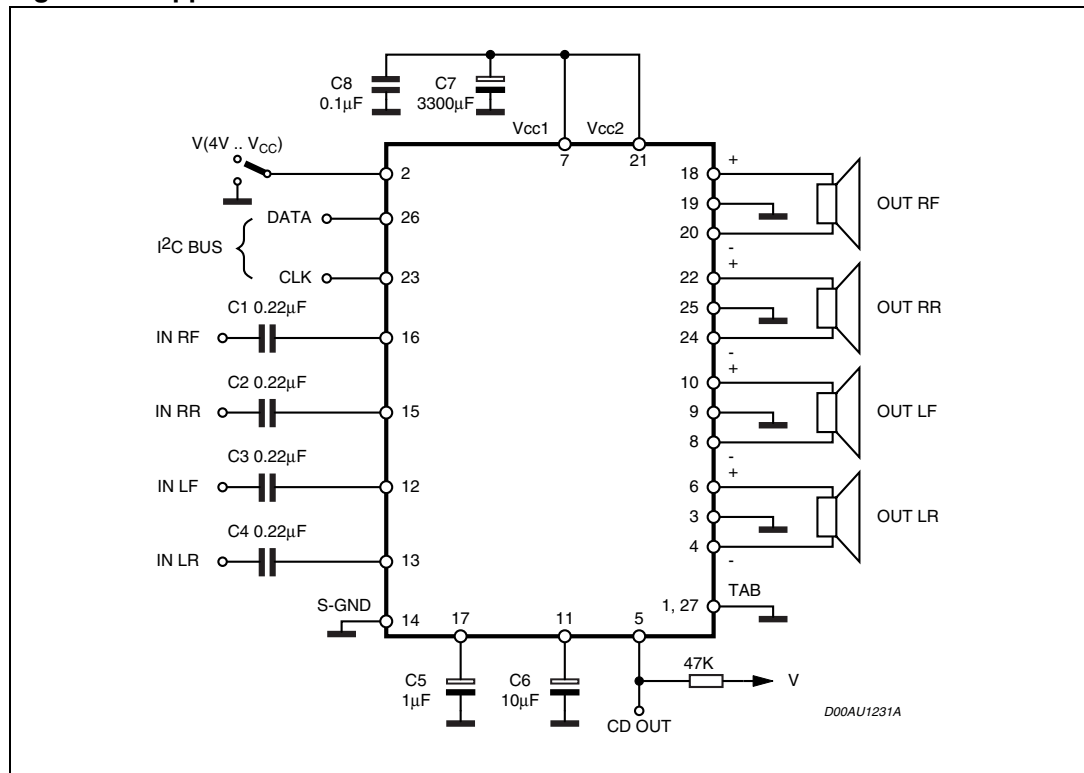


Figure 2. Application circuit



2 Pins description

Figure 3. Pins connection diagram of the Flexiwatt27 (Top of view)

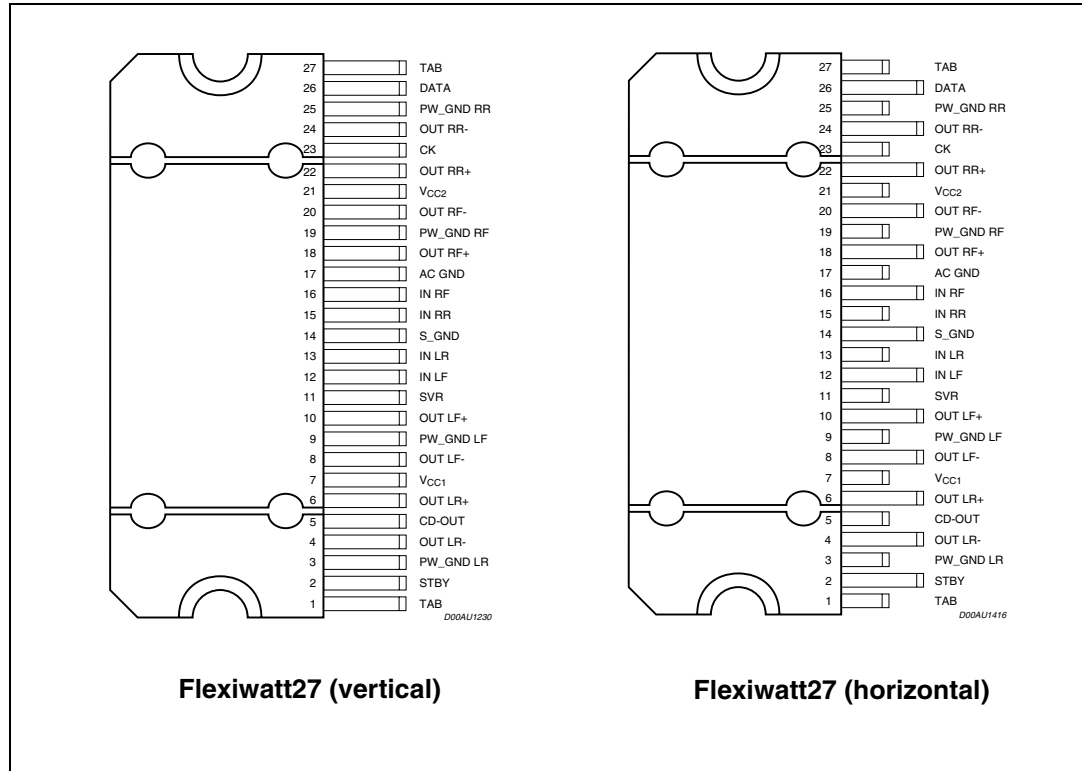
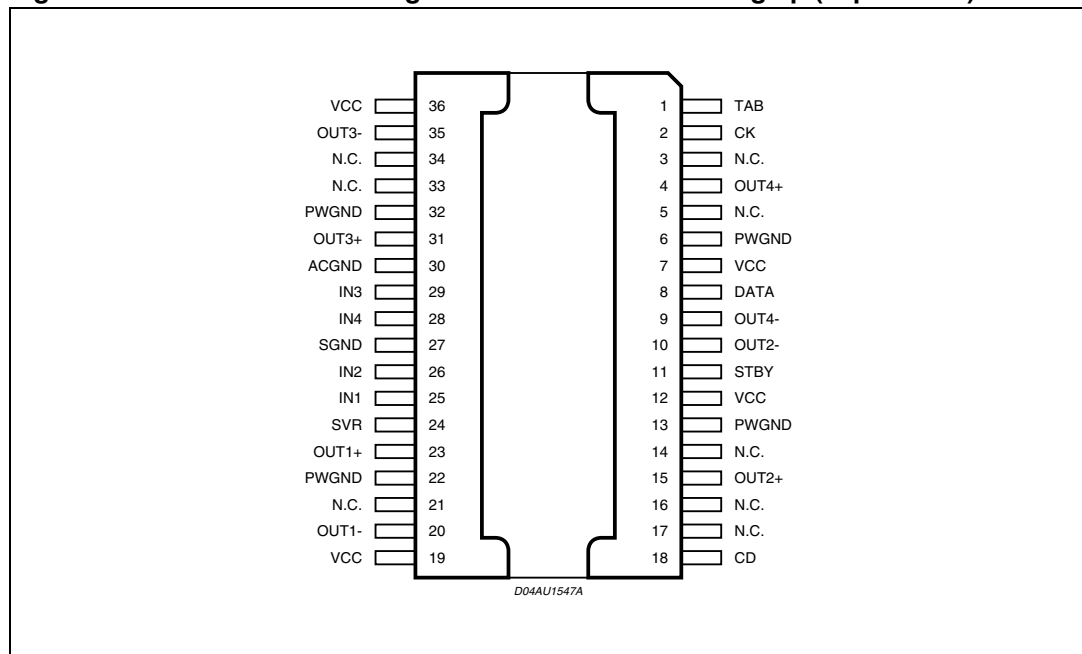


Figure 4. Pins connection diagram of the PowerSO36 slug up (Top of view)



3 Electrical specifications

3.1 Absolute maximum ratings

Table 1. Absolute Maximum Ratings

| Symbol | Parameter | Value | Unit |
|----------------|---|------------|-------------|
| V_{op} | Operating Supply Voltage | 18 | V |
| V_S | DC Supply Voltage | 28 | V |
| V_{peak} | Peak Supply Voltage (for $t = 50ms$) | 50 | V |
| V_{CK} | CK pin Voltage | 6 | V |
| V_{DATA} | Data Pin Voltage | 6 | V |
| I_O | Output Peak Current (not repetitive $t = 100ms$) | 8 | A |
| I_O | Output Peak Current (repetitive $f > 10Hz$) | 6 | A |
| P_{tot} | Power Dissipation $T_{case} = 70^{\circ}C$ | 85 | W |
| T_{stg}, T_j | Storage and Junction Temperature | -55 to 150 | $^{\circ}C$ |

3.2 Thermal data

Table 2. Thermal Data

| Symbol | Parameter | Value | Unit |
|------------------|-------------------------------------|--------|---------------|
| $R_{th\ j-case}$ | Thermal Resistance Junction to case | Max. 1 | $^{\circ}C/W$ |

3.3 Electrical characteristics

Refer to the test circuit, $V_S = 14.4V$; $R_L = 4\Omega$; $f = 1KHz$; $G_V = 30dB$; $T_{amb} = 25^{\circ}C$; unless otherwise specified.

Table 3. Electrical Characteristics

| Symbol | Parameter | Test Condition | Min. | Typ. | Max. | Unit |
|------------------------|-------------------------------|---|------|------|------|------|
| POWER AMPLIFIER | | | | | | |
| V_S | Supply Voltage Range | | 8 | | 18 | V |
| I_d | Total Quiescent Drain Current | | | 170 | 300 | mA |
| P_O | Output Power | Max. power ($V_S = 15.2V$, square wave input (2Vrms)) | | 50 | | W |
| | | THD = 10% | 25 | 28 | | W |
| | | THD = 1% | 20 | 22 | | W |

Table 3. Electrical Characteristics (continued)

| Symbol | Parameter | Test Condition | Min. | Typ. | Max. | Unit |
|-------------------|-------------------------------|---|------|------|----------------|------|
| P _O | Output Power | R _L = 2Ω; EIAJ (V _S = 13.7V) | 55 | 68 | | W |
| | | R _L = 2Ω; THD 10% | 40 | 50 | | W |
| | | R _L = 2Ω; THD 1% | 32 | 40 | | W |
| | | R _L = 2Ω; MAX POWER | 60 | 75 | | W |
| THD | Total Harmonic Distortion | P _O = 1W to 10W; STD MODE | | 0.03 | 0.1 | % |
| | | HE MODE; P _O = 1.5W | | 0.02 | 0.1 | % |
| | | HE MODE; P _O = 8W | | 0.15 | 0.5 | % |
| | | P _O = 1-10W, f = 10kHz | | 0.2 | 0.5 | % |
| | | G _V = 16dB; STD Mode V _O = 0.1 to 5VRMS | | 0.02 | 0.05 | % |
| C _T | Cross Talk | f = 1KHz to 10KHz, R _g = 600Ω | 50 | 60 | | dB |
| R _{IN} | Input Impedance | | 60 | 100 | 130 | KΩ |
| G _{V1} | Voltage Gain 1 | | 29.5 | 30 | 30.5 | dB |
| ΔG _{V1} | Voltage Gain Match 1 | | -1 | | 1 | dB |
| G _{V2} | Voltage Gain 2 | | 15.5 | 16 | 16.5 | dB |
| ΔG _{V2} | Voltage Gain Match 2 | | -1 | | 1 | dB |
| E _{IN1} | Output Noise Voltage 1 | R _g = 600Ω 20Hz to 22kHz | | 50 | 100 | μV |
| E _{IN2} | Output Noise Voltage 2 | R _g = 600Ω; G _V = 16dB 20Hz to 22kHz | | 15 | 30 | μV |
| SVR | Supply Voltage Rejection | f = 100Hz to 10kHz; V _r = 1Vpk; R _g = 600Ω | 50 | 60 | | dB |
| BW | Power Bandwidth | | 100 | | | KHz |
| A _{SB} | Stand-by Attenuation | | 90 | 110 | | dB |
| I _{SB} | Stand-by Current | V _{st-by} = 0 | | 1 | 10 | μA |
| A _M | Mute Attenuation | | 80 | 100 | | dB |
| V _{OS} | Offset Voltage | Mute & Play | -100 | 0 | 100 | mV |
| V _{AM} | Min. Supply Mute Threshold | | 7 | 7.5 | 8 | V |
| T _{ON} | Turn ON Delay | D2/D1 (IB1) 0 to 1 | | 5 | 20 | ms |
| T _{OFF} | Turn OFF Delay | D2/D1 (IB1) 1 to 0 | | 5 | 20 | ms |
| V _{SBY} | St-By/Mute pin for St-By | | 0 | | 1.5 | V |
| V _{MU} | St-By/Mute pin for Mute | | 3.5 | | 5 | V |
| CMRR | Input CMRR | V _{CM} = 1Vpk-pk; R _g = 0 Ω | | 55 | | dB |
| V _{OP} | St-By/Mute pin for Operating | | 7 | | V _S | V |
| I _{MU} | St-By/Mute pin Current | V _{st-by/mute} = 8.5V | | 20 | 40 | μA |
| | | V _{st-by/mute} < 1.5V | | 0 | 5 | μA |
| CD _{LK} | Clip Det High Leakage Current | CD off / V _{CD} = 6V | | 0 | 5 | μA |
| CD _{SAT} | Clip Det Sat. Voltage | CD on; I _{CD} = 1mA | | | 300 | mV |

Table 3. Electrical Characteristics (continued)

| Symbol | Parameter | Test Condition | Min. | Typ. | Max. | Unit |
|---|--|--|---------|------|---------|------|
| CD _{THD} | Clip Det THD level | D0 (IB1) = 1 | 5 | 10 | 15 | % |
| | | D0 (IB1) = 0 | 1 | 2 | 3 | % |
| TURN ON DIAGNOSTICS 1 (Power Amplifier Mode) | | | | | | |
| Pgnd | Short to GND det. (below this limit, the Output is considered in Short Circuit to GND) | Power Amplifier in st-by | | | 1.2 | V |
| Pvs | Short to Vs det. (above this limit, the Output is considered in Short Circuit to VS) | | Vs -1.2 | | | V |
| Pnop | Normal operation thresholds. (Within these limits, the Output is considered without faults). | | 1.8 | | Vs -1.8 | V |
| Lsc | Shorted Load det. | | | | 0.5 | Ω |
| Lop | Open Load det. | | 130 | | | Ω |
| Lnop | Normal Load det. | | 1.5 | | 70 | Ω |
| TURN ON DIAGNOSTICS 2 (Line Driver Mode) | | | | | | |
| Pgnd | Short to GND det. (below this limit, the Output is considered in Short Circuit to GND) | Power Amplifier in st-by | | | 1.2 | V |
| Pvs | Short to Vs det. (above this limit, the Output is considered in Short Circuit to VS) | | Vs -1.2 | | | V |
| Pnop | Normal operation thresholds. (Within these limits, the Output is considered without faults). | | 1.8 | | Vs -1.8 | V |
| Lsc | Shorted Load det. | | | | 1.5 | Ω |
| Lop | Open Load det. | | 400 | | | Ω |
| Lnop | Normal Load det. | | 4.5 | | 200 | Ω |
| PERMANENT DIAGNOSTICS 2 (Power Amplifier Mode or Line Driver Mode) | | | | | | |
| Pgnd | Short to GND det. (below this limit, the Output is considered in Short Circuit to GND) | Power Amplifier in Mute or Play, one or more short circuits protection activated | | | 1.2 | V |
| Pvs | Short to Vs det. (above this limit, the Output is considered in Short Circuit to VS) | | Vs -1.2 | | | V |
| Pnop | Normal operation thresholds. (Within these limits, the Output is considered without faults). | | 1.8 | | Vs -1.8 | V |

Table 3. Electrical Characteristics (continued)

| Symbol | Parameter | Test Condition | Min. | Typ. | Max. | Unit |
|-------------------------------------|-------------------------------|--|-----------|---------|-----------|----------|
| L_{SC} | Shorted Load Det. | Pow. Amp. mode | | | 0.5 | Ω |
| | | Line Driver mode | | | 1.5 | Ω |
| V_O | Offset Detection | Power Amplifier in play, AC Input signals = 0 | ± 1.5 | ± 2 | ± 2.5 | V |
| I_{NL} | Normal Load Current detection | $V_O < (V_S - 5)$ pk | 500 | | | mA |
| I_{OL} | Open Load Current detection | | | | 250 | mA |
| I²C BUS INTERFACE | | | | | | |
| S_{CL} | Clock Frequency | | | | 400 | KHz |
| V_{IL} | Input Low Voltage | | | | 1.5 | V |
| V_{IH} | Input High Voltage | | 2.3 | | | V |

3.4 Electrical characteristics curves

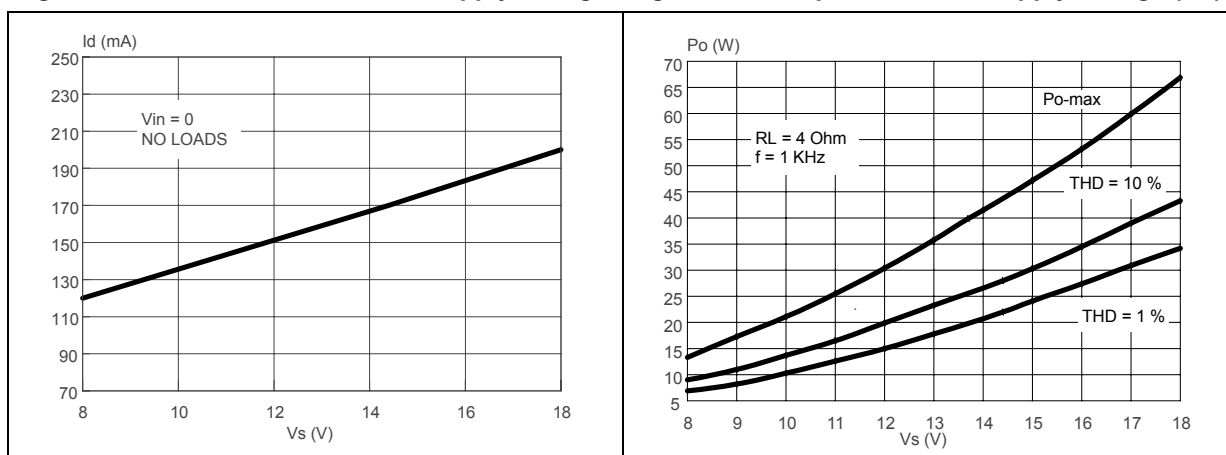
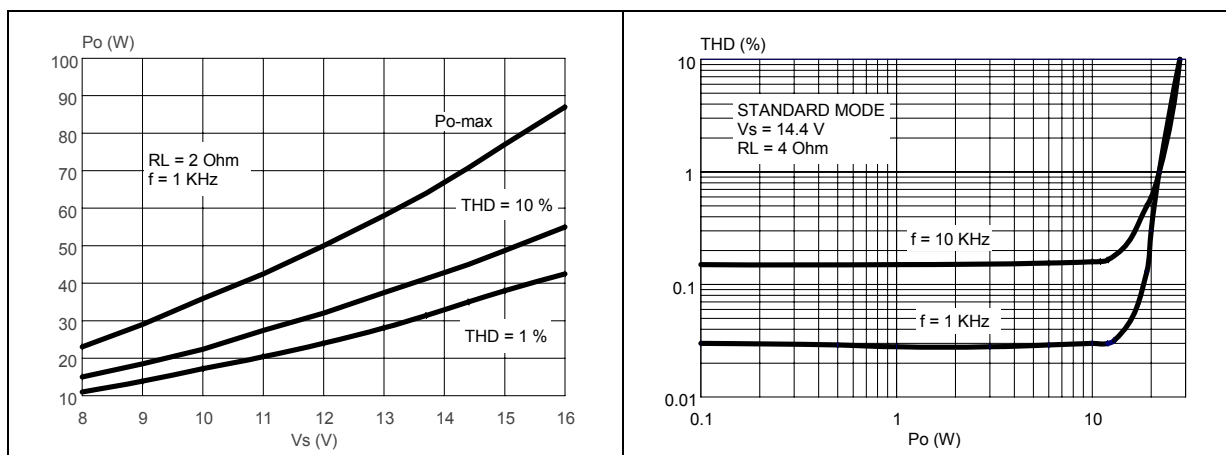
Figure 5. Quiescent Current vs. Supply Voltage Figure 6. Output Power vs. Supply Voltage (4 Ω)Figure 7. Output Power vs. Supply Voltage (2 Ω) Figure 8. Distortion vs. Output Power (4 Ω , STD)

Figure 9. Distortion vs. Output Power (4Ω, HI-EFF)

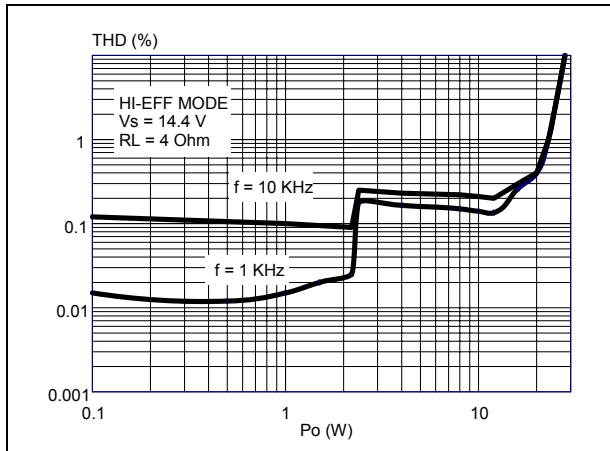


Figure 10. Distortion vs. Output Power (2Ω, STD)

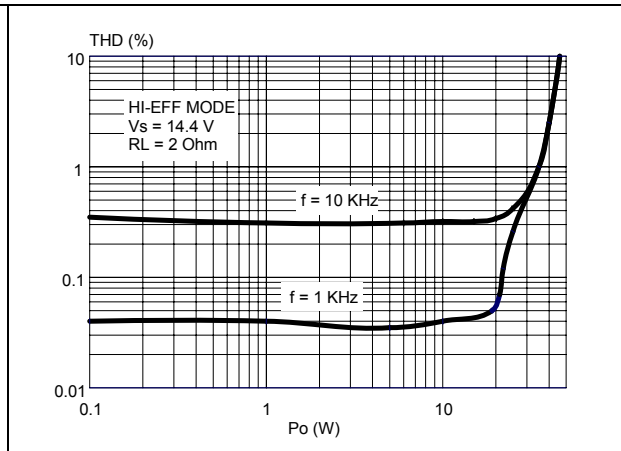


Figure 11. Distortion vs. Frequency (4Ω)

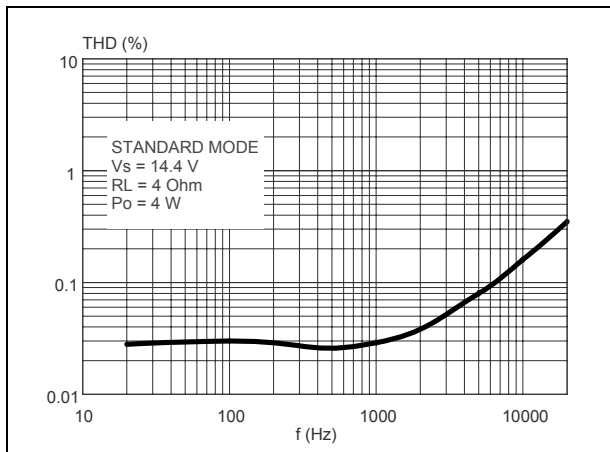


Figure 12. Distortion vs. Frequency (2Ω)

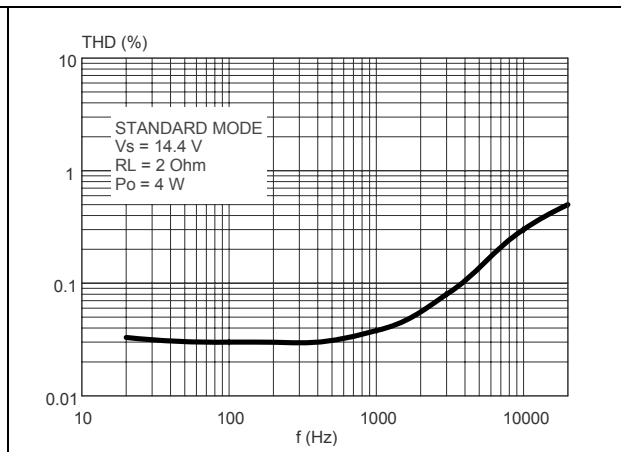


Figure 13. Crosstalk vs. Frequency

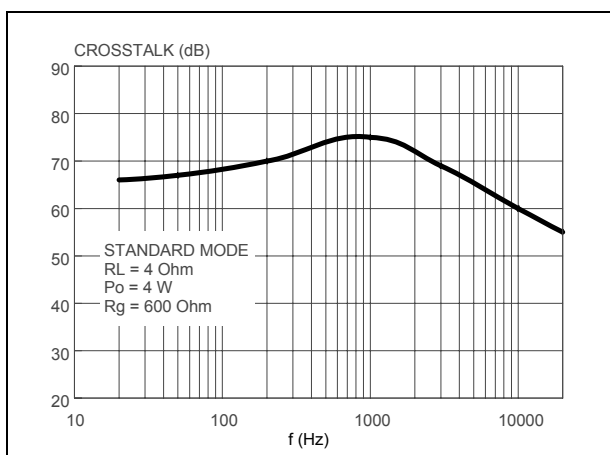


Figure 14. Supply Voltage Rejection vs. Freq.

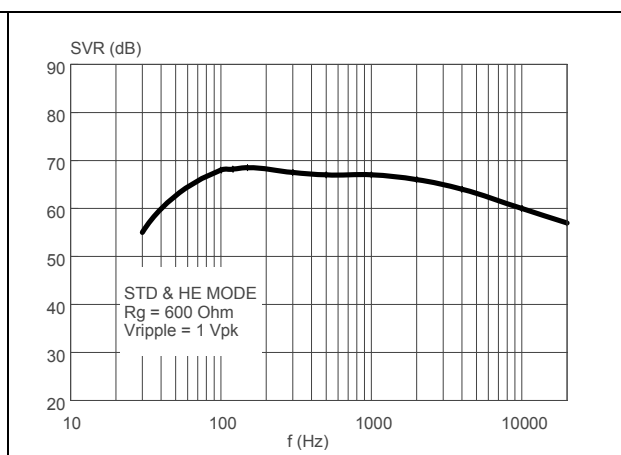


Figure 15. Power Dissipation & Efficiency vs. Output Power (4Ω, STD, SINE)

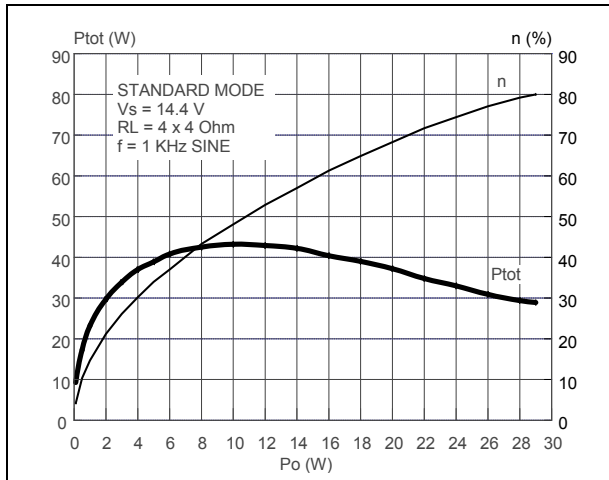


Figure 16. Power Dissipation & Efficiency vs. Output Power (4W, HI-EFF, SINE)

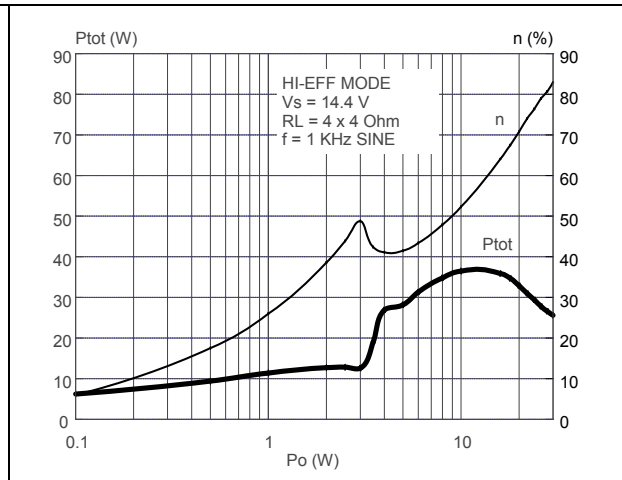


Figure 17. Power Dissipation vs. Average Output Power (Audio Program Simulation, 4Ω)

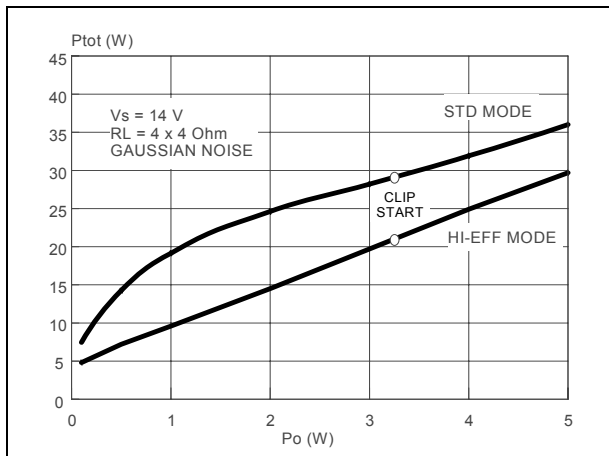
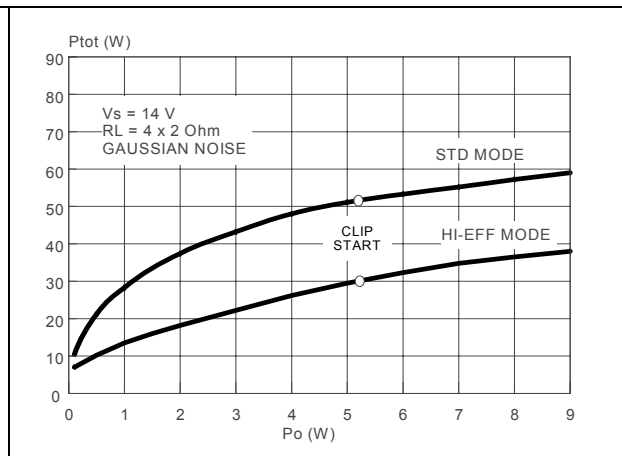


Figure 18. Power Dissipation vs. Average Output Power (Audio Program Simulation, 2Ω)



4 Diagnostics functional description

4.1 Turn-on diagnostic

It is activated at the turn-on (stand-by out) under I²Cbus request. Detectable output faults are:

- SHORT TO GND
- SHORT TO V_s
- SHORT ACROSS THE SPEAKER
- OPEN SPEAKER

To verify if any of the above misconnections are in place, a subsonic (inaudible) current pulse (fig. 19) is internally generated, sent through the speaker(s) and sunk back. The Turn On diagnostic status is internally stored until a successive diagnostic pulse is requested (after a I²C reading).

If the "stand-by out" and "diag. enable" commands are both given through a single programming step, the pulse takes place first (power stage still in stand-by mode, low, outputs= high impedance).

Afterwards, when the Amplifier is biased, the PERMANENT diagnostic takes place. The previous Turn On state is kept until a short appears at the outputs.

Figure 19. Turn - On diagnostic: working principle

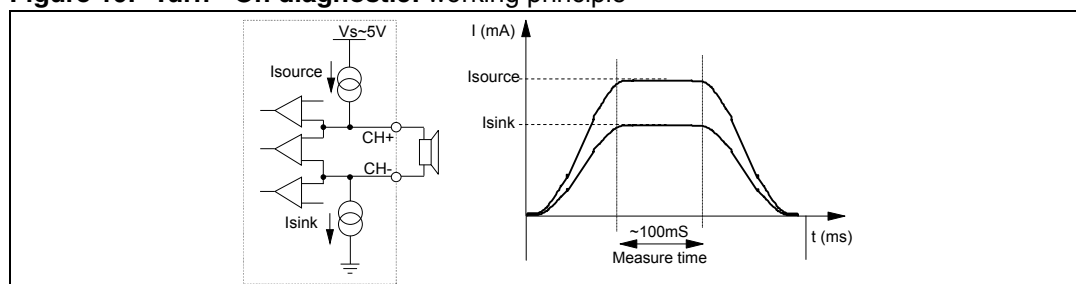


Figure 20 and 21 show SVR and OUTPUT waveforms at the turn-on (stand-by out) with and without turn-on diagnostic.

Figure 20. SVR and Output behaviour (Case 1: without turn-on diagnostic)

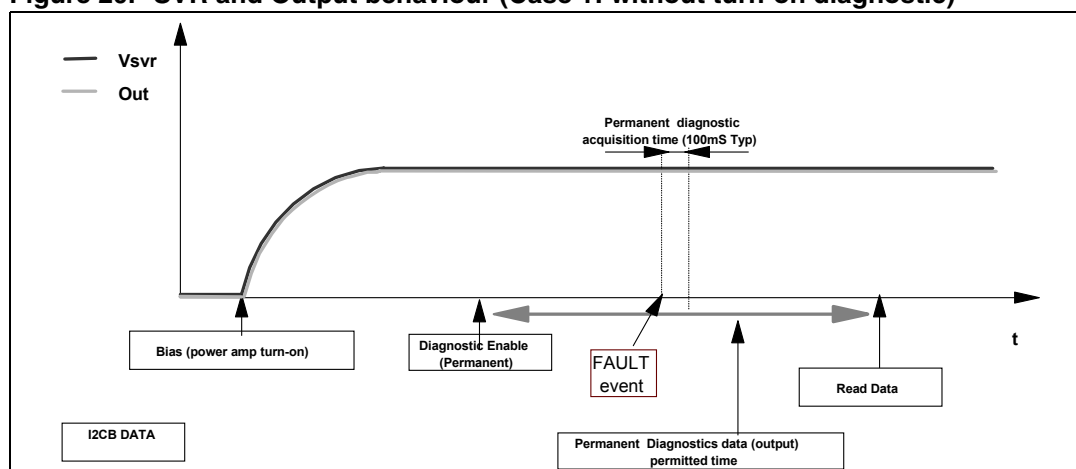
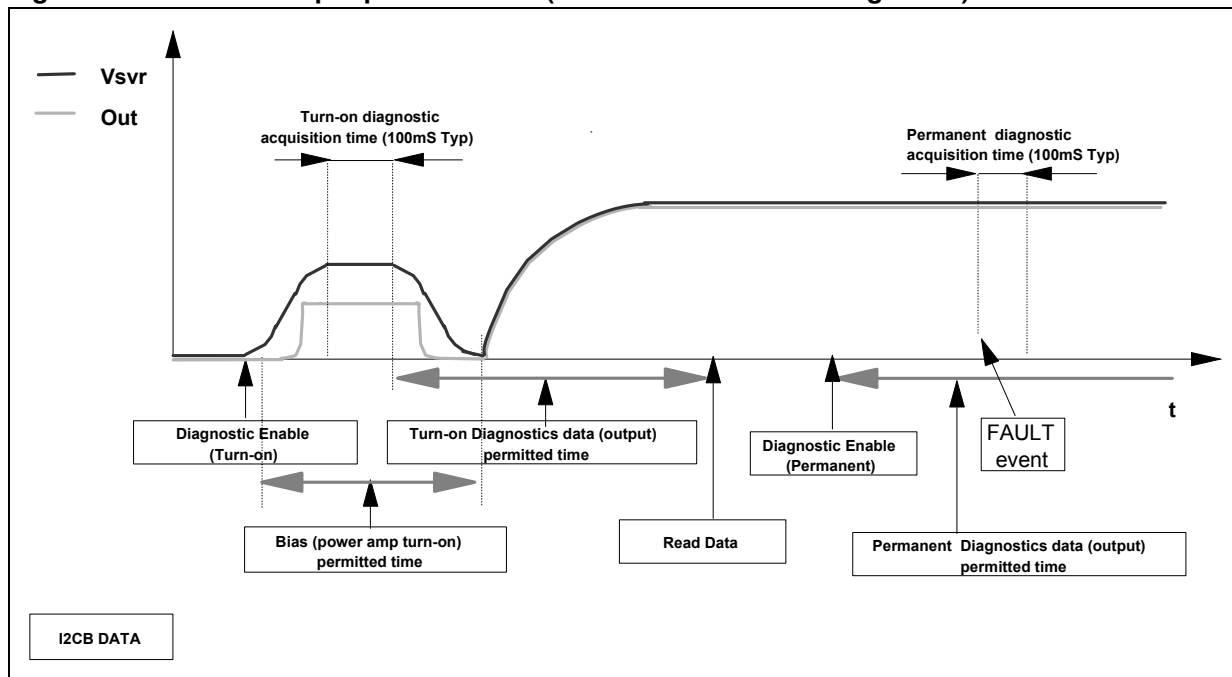
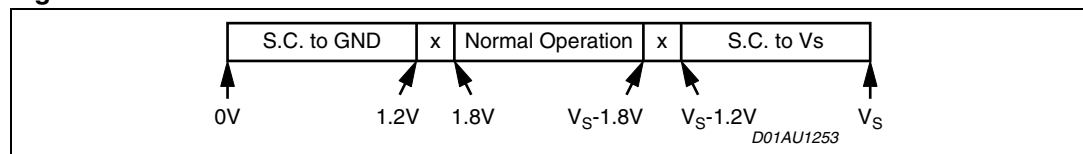


Figure 21. SVR and Output pin behaviour (CASE 2: with turn-on diagnostic)



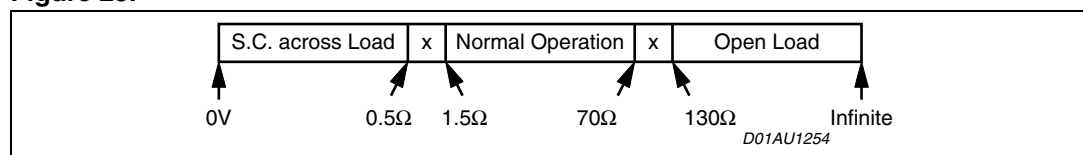
The information related to the outputs status is read and memorized at the end of the current pulse top. The acquisition time is 100 ms (typ.). No audible noise is generated in the process. As for SHORT TO GND / Vs the fault-detection thresholds remain unchanged from 30 dB to 16 dB gain setting. They are as follows: TDA7563B

Figure 22.



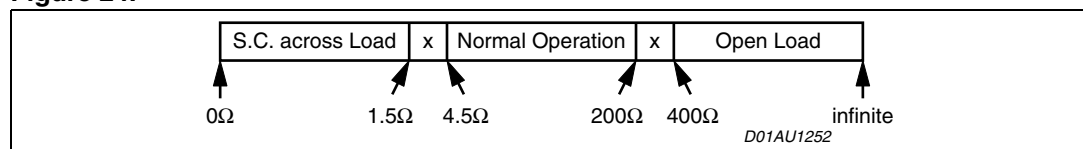
Concerning SHORT ACROSS THE SPEAKER / OPEN SPEAKER, the threshold varies from 30 dB to 16 dB gain setting, since different loads are expected (either normal speaker's impedance or high impedance). The values in case of 30 dB gain are as follows:

Figure 23.



If the Line-Driver mode ($G_v = 16$ dB and Line Driver Mode diagnostic = 1) is selected, the same thresholds will change as follows:

Figure 24.



4.2 Permanent diagnostics

Detectable conventional faults are:

- SHORT TO GND
- SHORT TO Vs
- SHORT ACROSS THE SPEAKER

The following additional features are provided:

- OUTPUT OFFSET DETECTION

The TDA7563B has 2 operating statuses:

1. **RESTART mode.** The diagnostic is not enabled. Each audio channel operates independently from each other. If any of the a.m. faults occurs, only the channel(s) interested is shut down. A check of the output status is made every 1 ms (*Figure 25*). Restart takes place when the overload is removed.
2. **DIAGNOSTIC mode.** It is enabled via I²C bus and self activates if an output overload (such to cause the intervention of the short-circuit protection) occurs to the speakers outputs . Once activated, the diagnostics procedure develops as follows (*Figure 26*):
 - To avoid momentary re-circulation spikes from giving erroneous diagnostics, a check of the output status is made after 1ms: if normal situation (no overloads) is detected, the diagnostic is not performed and the channel returns back active.
 - Instead, if an overload is detected during the check after 1 ms, then a diagnostic cycle having a duration of about 100 ms is started.
 - After a diagnostic cycle, the audio channel interested by the fault is switched to RESTART mode. The relevant data are stored inside the device and can be read by the microprocessor. When one cycle has terminated, the next one is activated by an I²C reading. This is to ensure continuous diagnostics throughout the car-radio operating time.
 - To check the status of the device a sampling system is needed. The timing is chosen at microprocessor level (over half a second is recommended).

Figure 25. Restart timing without Diagnostic Enable (Permanent) - Each 1mS time, a sampling of the fault is done

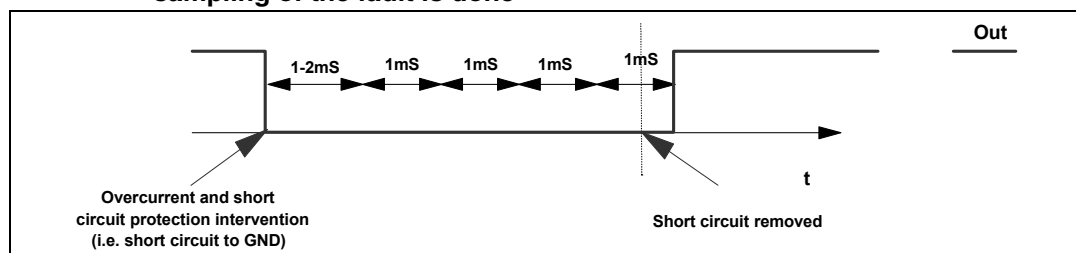
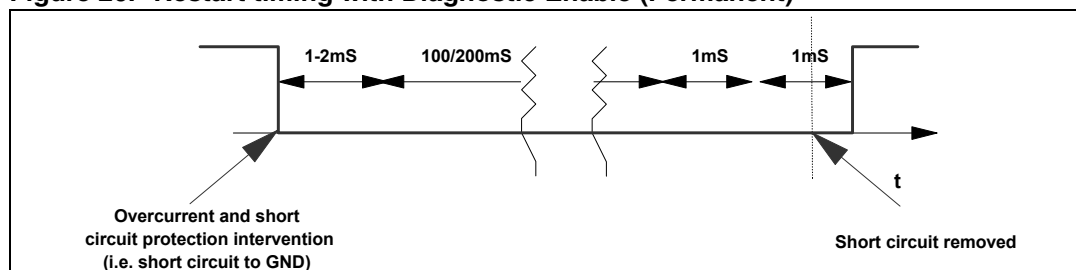


Figure 26. Restart timing with Diagnostic Enable (Permanent)



4.3 Output DC offset detection

Any DC output offset exceeding ± 2 V are signalled out. This inconvenient might occur as a consequence of initially defective or aged and worn-out input capacitors feeding a DC component to the inputs, so putting the speakers at risk of overheating.

This diagnostic has to be performed with low-level output AC signal (or $V_{in} = 0$).

The test is run with selectable time duration by microprocessor (from a "start" to a "stop" command):

- START = Last reading operation or setting IB1 - D5 - (OFFSET enable) to 1
- STOP = Actual reading operation

Excess offset is signalled out if persistent throughout the assigned testing time. This feature is disabled if any overloads leading to activation of the short-circuit protection occurs in the process.

4.4 AC diagnostic

It is targeted at detecting accidental disconnection of tweeters in 2-way speaker and, more in general, presence of capacitively (AC) coupled loads.

This diagnostic is based on the notion that the overall speaker's impedance (woofer + parallel tweeter) will tend to increase towards high frequencies if the tweeter gets disconnected, because the remaining speaker (woofer) would be out of its operating range (high impedance). The diagnostic decision is made according to peak output current thresholds, as follows:

$I_{out} > 500\text{mA}_{pk} = \text{NORMAL STATUS}$

$I_{out} < 250\text{mA}_{pk} = \text{OPEN TWEETER}$

To correctly implement this feature, it is necessary to briefly provide a signal tone (with the amplifier in "play") whose frequency and magnitude are such to determine an output current higher than 500mA_{pk} with in normal conditions and lower than 250mA_{pk} should the parallel tweeter be missing.

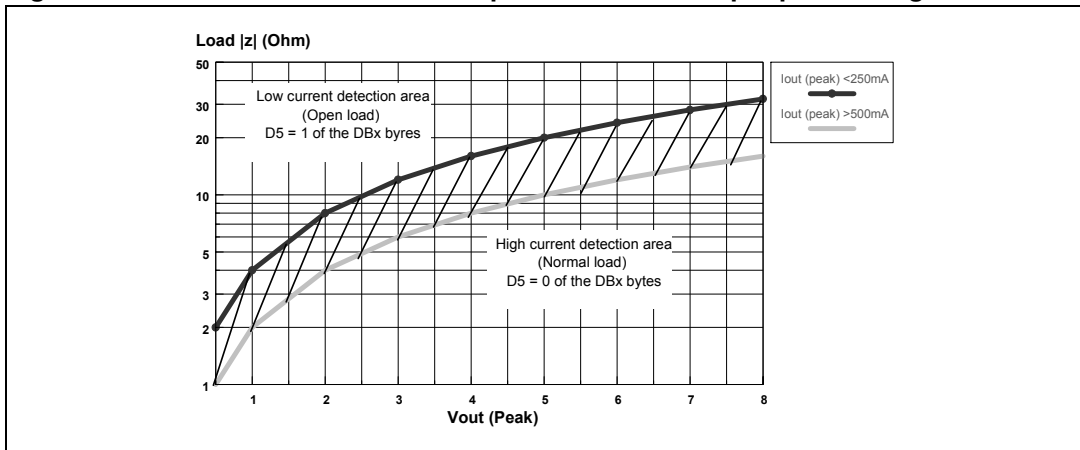
The test has to last for a minimum number of 3 sine cycles starting from the activation of the AC diagnostic function IB2<D2> up to the I²C reading of the results (measuring period). To confirm presence of tweeter, it is necessary to find at least 3 current pulses over 500mA over all the measuring period, else an "open tweeter" message will be issued.

The frequency / magnitude setting of the test tone depends on the impedance characteristics of each specific speaker being used, with or without the tweeter connected (to be calculated case by case). High-frequency tones (> 10 KHz) or even ultrasonic signals are recommended for their negligible acoustic impact and also to maximize the impedance module's ratio between with tweeter-on and tweeter-off.

Figure 27 shows the Load Impedance as a function of the peak output voltage and the relevant diagnostic fields.

This feature is disabled if any overloads leading to activation of the short-circuit protection occurs in the process.

Figure 27. Current detection: Load impedance |Z| vs. output peak voltage



5 Multiple faults

When more misconnections are simultaneously in place at the audio outputs, it is guaranteed that at least one of them is initially read out. The others are notified after successive cycles of I²C reading and faults removal, provided that the diagnostic is enabled. This is true for both kinds of diagnostic (Turn on and Permanent).

The table below shows all the couples of double-fault possible. It should be taken into account that a short circuit with the 4 ohm speaker unconnected is considered as double fault.

Table 4. Double fault table for Turn On Diagnostic

| | S. GND (so) | S. GND (sk) | S. Vs | S. Across L. | Open L. |
|--------------|-------------|-------------|----------------|--------------|-------------|
| S. GND (so) | S. GND | S. GND | S. Vs + S. GND | S. GND | S. GND |
| S. GND (sk) | / | S. GND | S. Vs | S. GND | Open L. (*) |
| S. Vs | / | / | S. Vs | S. Vs | S. Vs |
| S. Across L. | / | / | / | S. Across L. | N.A. |
| Open L. | / | / | / | / | Open L. (*) |

S. GND (so) / S. GND (sk) in the above table make a distinction according to which of the 2 outputs is shorted to ground (test-current source side= so, test-current sink side = sk). More precisely, in Channels LF and RR, so = CH+, sk = CH-; in Channels LR and RF, so = CH-, sk = CH+.

In Permanent Diagnostic the table is the same, with only a difference concerning Open Load(*), which is not among the recognisable faults. Should an Open Load be present during the device's normal working, it would be detected at a subsequent Turn on Diagnostic cycle (i.e. at the successive Car Radio Turn on).

5.1 Faults availability

All the results coming from I²Cbus, by read operations, are the consequence of measurements inside a defined period of time. If the fault is stable throughout the whole period, it will be sent out.

To guarantee always resident functions, every kind of diagnostic cycles (Turn on, Permanent, Offset) will be reactivate after any I²C reading operation. So, when the micro reads the I²C, a new cycle will be able to start, but the read data will come from the previous diag. cycle (i.e. The device is in Turn On state, with a short to Gnd, then the short is removed and micro reads I²C. The short to Gnd is still present in bytes, because it is the result of the previous cycle. If another I²C reading operation occurs, the bytes do not show the short). In general to observe a change in Diagnostic bytes, two I²C reading operations are necessary.

6 Thermal protection

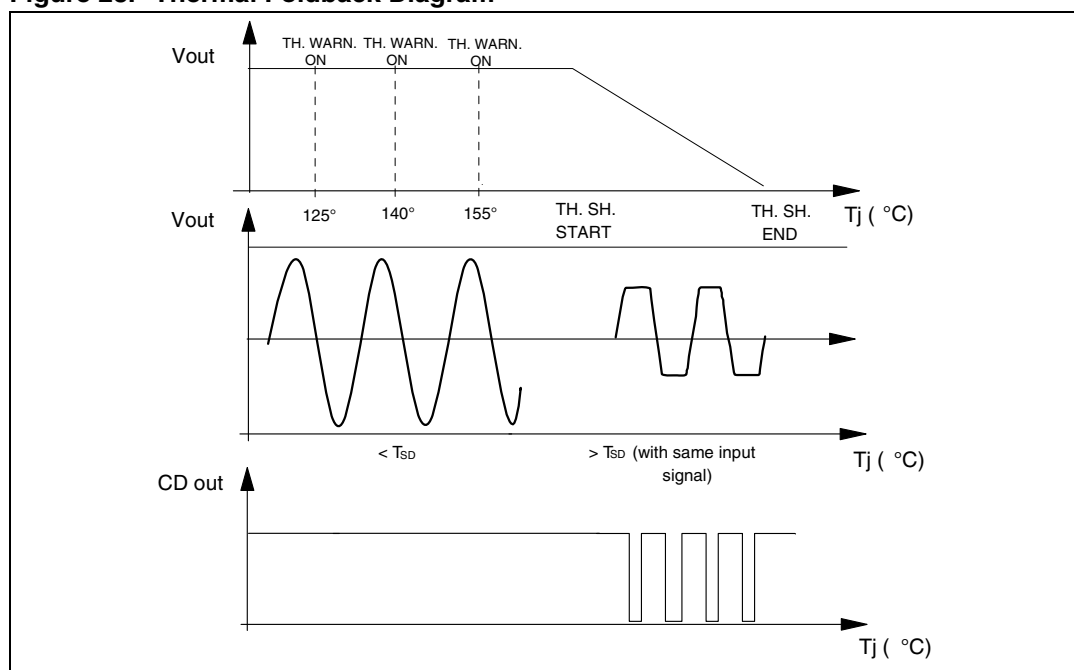
Thermal protection is implemented through thermal foldback ([Figure 28](#)).

Thermal foldback begins limiting the audio input to the amplifier stage as the junction temperatures rise above the normal operating range. This effectively limits the output power capability of the device thus reducing the temperature to acceptable levels without totally interrupting the operation of the device.

The output power will decrease to the point at which thermal equilibrium is reached. Thermal equilibrium will be reached when the reduction in output power reduces the dissipated power such that the die temperature falls below the thermal foldback threshold. Should the device cool, the audio level will increase until a new thermal equilibrium is reached or the amplifier reaches full power. Thermal foldback will reduce the audio output level in a linear manner.

Three Thermal warning are available through the I²C bus data.

Figure 28. Thermal Foldback Diagram



6.1 Fast muting

The muting time can be shortened to less than 1.5ms by setting (IB2) D5 = 1. This option can be useful in transient battery situations (i.e. during car engine cranking) to quickly turnoff the amplifier for avoiding any audible effects caused by noise/transients being injected by preamp stages. The bit must be set back to "0" shortly after the mute transition.

7 I²C Bus

7.1 I²C Programming/reading sequences

A correct turn on/off sequence respectful of the diagnostic timings and producing no audible noises could be as follows (after battery connection):

- TURN-ON: PIN2 > 7V --- 10ms --- (STAND-BY OUT + DIAG ENABLE) --- 500 ms (min) --- MUTING OUT
- TURN-OFF: MUTING IN --- 20 ms --- (DIAG DISABLE + STAND-BY IN) --- 10ms - -- PIN2 = 0
- Car Radio Installation: PIN2 > 7V --- 10ms DIAG ENABLE (write) --- 200 ms --- I2C read (repeat until All faults disappear).
- OFFSET TEST: Device in Play (no signal) -- OFFSET ENABLE - 30ms - I2C reading (repeat I2C reading until high-offset message disappears).

7.2 I²C Bus interface

Data transmission from microprocessor to the TDA7563B and viceversa takes place through the 2 wires I²C BUS interface, consisting of the two lines SDA and SCL (pull-up resistors to positive supply voltage must be connected).

7.2.1 Data Validity

As shown by [Figure 29](#), the data on the SDA line must be stable during the high period of the clock. The HIGH and LOW state of the data line can only change when the clock signal on the SCL line is LOW.

7.2.2 Start and Stop Conditions

As shown by [Figure 30](#) a start condition is a HIGH to LOW transition of the SDA line while SCL is HIGH. The stop condition is a LOW to HIGH transition of the SDA line while SCL is HIGH.

7.2.3 Byte Format

Every byte transferred to the SDA line must contain 8 bits. Each byte must be followed by an acknowledge bit. The MSB is transferred first.

7.2.4 Acknowledge

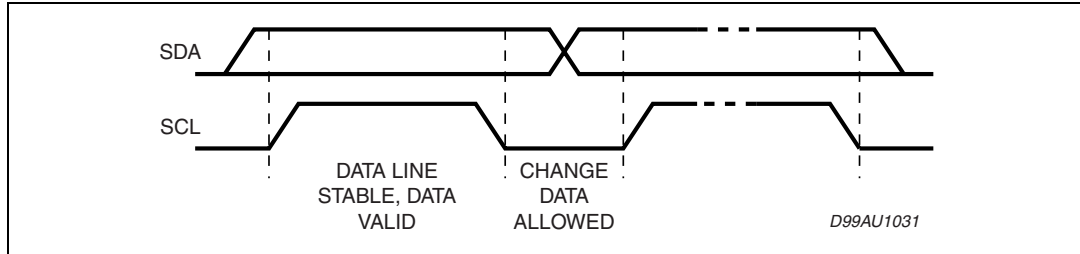
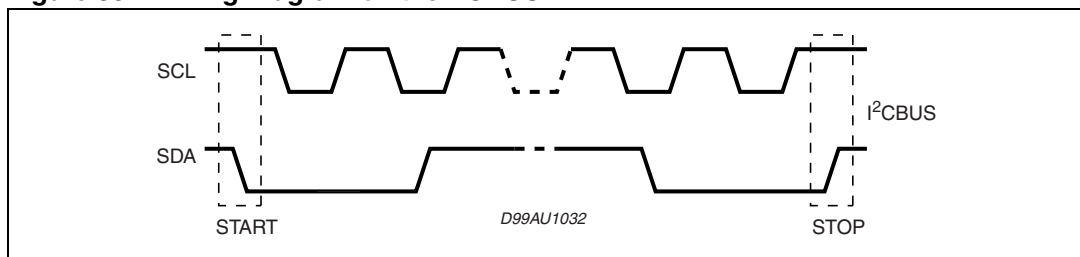
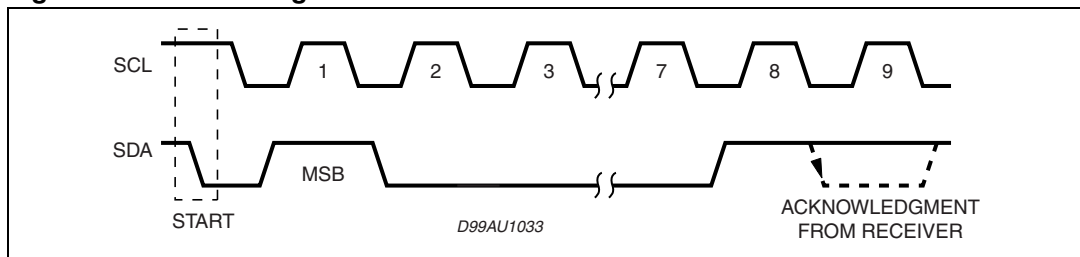
The transmitter* puts a resistive HIGH level on the SDA line during the acknowledge clock pulse (see [Figure 31](#)). The receiver** the acknowledges has to pull-down (LOW) the SDA line during the acknowledge clock pulse, so that the SDA line is stable LOW during this clock pulse.

* Transmitter

- master (μ P) when it writes an address to the TDA7563B
- slave (TDA7563B) when the μ P reads a data byte from TDA7563B

** Receiver

- slave (TDA7563B) when the μ P writes an address to the TDA7563B
- master (μ P) when it reads a data byte from TDA7563B

Figure 29. Data Validity on the I²C BUSFigure 30. Timing Diagram on the I²C BUSFigure 31. Acknowledge on the I²C BUS

8 Software specifications

All the functions of the TDA7563B are activated by I²C interface.

The bit 0 of the "ADDRESS BYTE" defines if the next bytes are write instruction (from μ P to TDA7563B) or read instruction (from TDA7563B to μ P).

Table 5. Chip Address:

| D7 | | | | | | | D0 | D8 Hex |
|----|---|---|---|---|---|---|----|--------|
| 1 | 1 | 0 | 1 | 1 | 0 | 0 | X | |

X = 0 Write to device

X = 1 Read from device

If R/W = 0, the μ P sends 2 "Instruction Bytes": IB1 and IB2.

Table 6. IB1

| | |
|-----------|--|
| D7 | 0 |
| D6 | Diagnostic enable (D6 = 1) Diagnostic defeat (D6 = 0) |
| D5 | Offset Detection enable (D5 = 1) Offset Detection defeat (D5 = 0) |
| D4 | Front Channel Gain = 30dB (D4 = 0) Gain = 16dB (D4 = 1) |
| D3 | Rear Channel Gain = 30dB (D3 = 0) Gain = 16dB (D3 = 1) |
| D2 | Mute front channels (D2 = 0) Unmute front channels (D2 = 1) |
| D1 | Mute rear channels (D1 = 0) Unmute rear channels (D1 = 1) |
| D0 | CD 2% (D0 = 0) CD 10% (D0 = 1) |

Table 7. IB2

| | |
|-----------|---|
| D7 | 0 |
| D6 | 0 |
| D5 | Normal muting time (D5 = 0) Fast muting time (D5 = 1) |
| D4 | Stand-by on - Amplifier not working - (D4 = 0) Stand-by off - Amplifier working - (D4 = 1) |
| D3 | Power amplifier mode diagnostic (D3 = 0) Line driver mode diagnostic (D3 = 1) |

Table 7. IB2 (continued)

| | |
|-----------|---|
| D2 | Current Detection Diagnostic Enabled (D2 =1) Current Detection Diagnostic Defeat (D2 =0) |
| D1 | Right Channel Power amplifier working in standard mode (D1 = 0) Power amplifier working in high efficiency mode (D1 = 1) |
| D0 | Left Channel Power amplifier working in standard mode (D0 = 0) Power amplifier working in high efficiency mode (D0 = 1) |

If R/W = 1, the TDA7563B sends 4 "Diagnostics Bytes" to μ P: DB1, DB2, DB3 and DB4.

Table 8. DB1

| | |
|-----------|---|
| D7 | Thermal warning 1 active (D7 = 1), $T_j = 155^\circ\text{C}$ |
| D6 | Diag. cycle not activated or not terminated (D6 = 0) Diag. cycle terminated (D6 = 1) |
| D5 | Channel LF Current Detection Output peak current <250mA - Output load (D5 = 1) Output peak current >500mA - Output load (D5 = 0) |
| D4 | Channel LF Turn-on diagnostic (D4 = 0) Permanent diagnostic (D4 = 1) |
| D3 | Channel LF Normal load (D3 = 0) Short load (D3 = 1) |
| D2 | Channel LF Turn-on diag.: No open load (D2 = 0) Open load detection (D2 = 1) Offset diag.: No output offset (D2 = 0) Output offset detection (D2 = 1) |
| D1 | Channel LF No short to Vcc (D1 = 0) Short to Vcc (D1 = 1) |
| D0 | Channel LF No short to GND (D1 = 0) Short to GND (D1 = 1) |

Table 9. DB2

| | |
|-----------|---|
| D7 | Offset detection not activated (D7 = 0) Offset detection activated (D7 = 1) |
| D6 | X |
| D5 | Channel LR Current Detection Output peak current <250mA - Output load (D5 = 1) Output peak current >500mA - Output load (D5 = 0) |

Table 9. DB2 (continued)

| | |
|-----------|--|
| D4 | Channel LR Turn-on diagnostic (D4 = 0) Permanent diagnostic (D4 = 1) |
| D3 | Channel LR Normal load (D3 = 0) Short load (D3 = 1) |
| D2 | Channel LR Turn-on diag.: No open load (D2 = 0) Open load detection (D2 = 1) Permanent diag.: No output offset (D2 = 0) Output offset detection (D2 = 1) |
| D1 | Channel LR No short to Vcc (D1 = 0) Short to Vcc (D1 = 1) |
| D0 | Channel LR No short to GND (D1 = 0) Short to GND (D1 = 1) |

Table 10. DB3

| | |
|-----------|--|
| D7 | Stand-by status (= IB1 - D4) |
| D6 | Diagnostic status (= IB1 - D6) |
| D5 | Channel RF Current Detection Output peak current <250mA - Output load (D5 = 1) Output peak current >500mA - Output load (D5 = 0) |
| D4 | Channel RF Turn-on diagnostic (D4 = 0) Permanent diagnostic (D4 = 1) |
| D3 | Channel RF Normal load (D3 = 0) Short load (D3 = 1) |
| D2 | Channel RF Turn-on diag.: No open load (D2 = 0) Open load detection (D2 = 1) Permanent diag.: No output offset (D2 = 0) Output offset detection (D2 = 1) |
| D1 | Channel RF No short to Vcc (D1 = 0) Short to Vcc (D1 = 1) |
| D0 | Channel RF No short to GND (D1 = 0) Short to GND (D1 = 1) |

Table 11. DB4

| | |
|-----------|--|
| D7 | Thermal warning 2 active (D7 = 1), $T_j = 140^\circ\text{C}$ |
| D6 | Thermal warning 3 active (D6 = 1) $T_j = 120^\circ\text{C}$ |
| D5 | Channel RR Current Detection Output peak current <250mA - Output load (D5 = 1) Output peak current >500mA - Output load (D5 = 0) |
| D4 | Channel RR Turn-on diagnostic (D4 = 0) Permanent diagnostic (D4 = 1) |
| D3 | Channel R RNormal load (D3 = 0) Short load (D3 = 1) |
| D2 | Channel RR Turn-on diag.: No open load (D2 = 0) Open load detection (D2 = 1) Permanent diag.: No output offset (D2 = 0) Output offset detection (D2 = 1) |
| D1 | Channel RR No short to Vcc (D1 = 0) Short to Vcc (D1 = 1) |
| D0 | Channel RR No short to GND (D1 = 0) Short to GND (D1 = 1) |

9 Examples of bytes sequence

1 - Turn-On diagnostic - Write operation

| | | | | | | | |
|-------|--------------------------|-----|-----------------|-----|-----|-----|------|
| Start | Address byte with D0 = 0 | ACK | IB1 with D6 = 1 | ACK | IB2 | ACK | STOP |
|-------|--------------------------|-----|-----------------|-----|-----|-----|------|

2 - Turn-On diagnostic - Read operation

| | | | | | | | | | | | |
|-------|--------------------------|-----|-----|-----|-----|-----|-----|-----|-----|-----|------|
| Start | Address byte with D0 = 1 | ACK | DB1 | ACK | DB2 | ACK | DB3 | ACK | DB4 | ACK | STOP |
|-------|--------------------------|-----|-----|-----|-----|-----|-----|-----|-----|-----|------|

The delay from 1 to 2 can be selected by software, starting from 1ms

3a - Turn-On of the power amplifier with 30dB gain, mute on, diagnostic defeat, CD = 2%

| | | | | | | | |
|-------|--------------------------|-----|----------|-----|----------|-----|------|
| Start | Address byte with D0 = 0 | ACK | IB1 | ACK | IB2 | ACK | STOP |
| | | | X0000000 | | XXX1XX11 | | |

3b - Turn-Off of the power amplifier

| | | | | | | | |
|-------|--------------------------|-----|----------|-----|----------|-----|------|
| Start | Address byte with D0 = 0 | ACK | IB1 | ACK | IB2 | ACK | STOP |
| | | | X0XXXXXX | | XXX0XXXX | | |

4 - Offset detection procedure enable

| | | | | | | | |
|-------|--------------------------|-----|----------|-----|----------|-----|------|
| Start | Address byte with D0 = 0 | ACK | IB1 | ACK | IB2 | ACK | STOP |
| | | | XX1XX11X | | XXX1XXXX | | |

5 - Offset detection procedure stop and reading operation (the results are valid only for the offset detection bits (D2 of the bytes DB1, DB2, DB3, DB4))

| | | | | | | | | | | | |
|-------|--------------------------|-----|-----|-----|-----|-----|-----|-----|-----|-----|------|
| Start | Address byte with D0 = 1 | ACK | DB1 | ACK | DB2 | ACK | DB3 | ACK | DB4 | ACK | STOP |
|-------|--------------------------|-----|-----|-----|-----|-----|-----|-----|-----|-----|------|

- The purpose of this test is to check if a D.C. offset (2V typ.) is present on the outputs, produced by input capacitor with anomalous leakage current or humidity between pins.
- The delay from 4 to 5 can be selected by software, starting from 1ms

10 Package information

In order to meet environmental requirements, ST offers these devices in ECOPACK® packages. These packages have a Lead-free second level interconnect. The category of second Level Interconnect is marked on the package and on the inner box label, in compliance with JEDEC Standard JESD97. The maximum ratings related to soldering conditions are also marked on the inner box label. ECOPACK is an ST trademark. ECOPACK specifications are available at: www.st.com.

Figure 32. Flexiwatt27 (horizontal) Mechanical Data & Package Dimensions

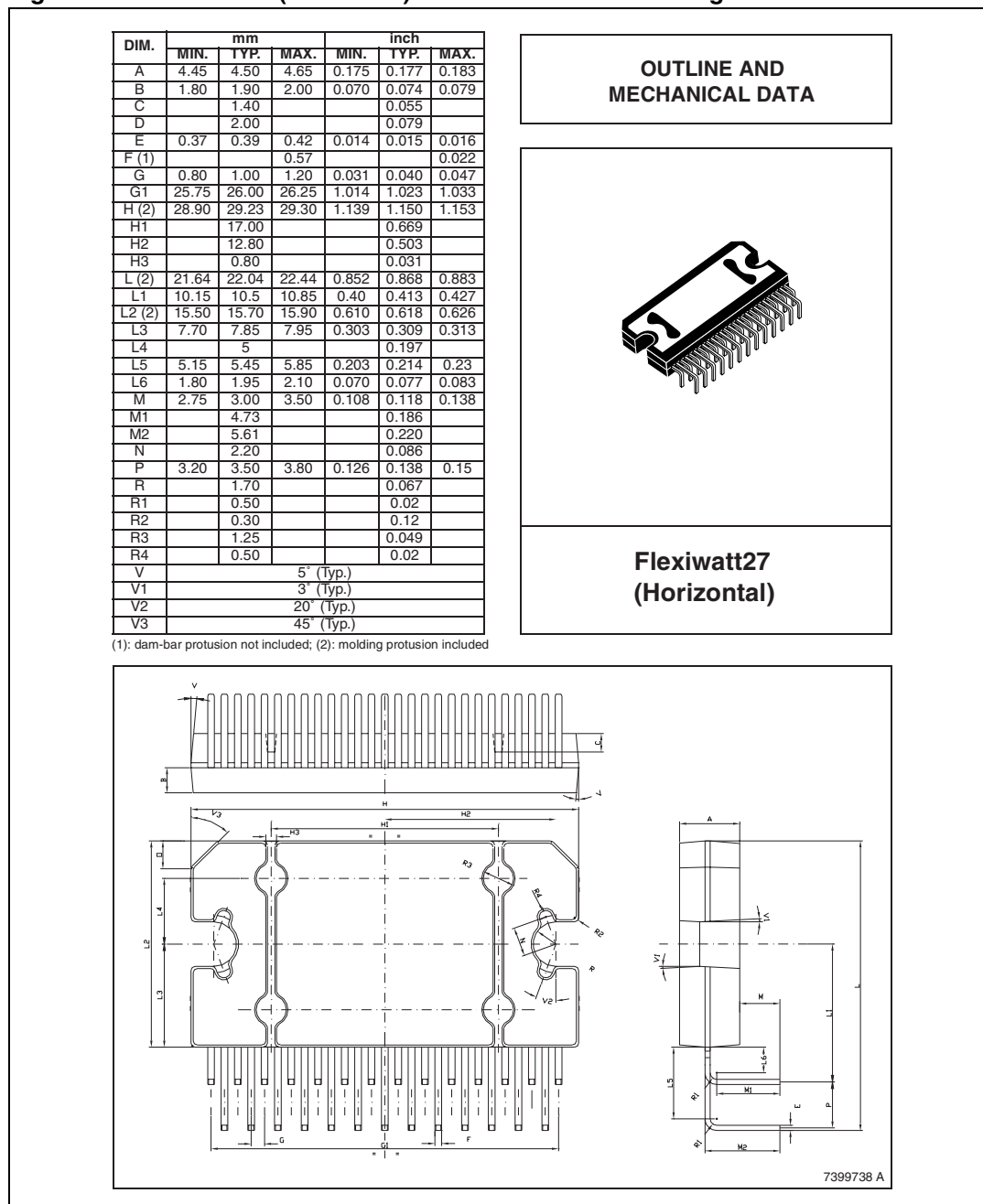
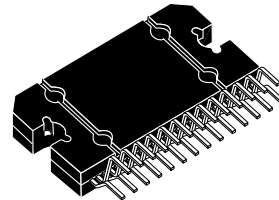


Figure 33. Flexiwatt27 (vertical) Mechanical Data & Package Dimensions

| DIM. | mm | | | inch | | |
|--------|------------|-------|-------|-------|-------|-------|
| | MIN. | TYP. | MAX. | MIN. | TYP. | MAX. |
| A | 4.45 | 4.50 | 4.65 | 0.175 | 0.177 | 0.183 |
| B | 1.80 | 1.90 | 2.00 | 0.070 | 0.074 | 0.079 |
| C | | 1.40 | | | 0.055 | |
| D | 0.75 | 0.90 | 1.05 | 0.029 | 0.035 | 0.041 |
| E | 0.37 | 0.39 | 0.42 | 0.014 | 0.015 | 0.016 |
| F (1) | | | 0.57 | | | 0.022 |
| G | 0.80 | 1.00 | 1.20 | 0.031 | 0.040 | 0.047 |
| G1 | 25.75 | 26.00 | 26.25 | 1.014 | 1.023 | 1.033 |
| H (2) | 28.90 | 29.23 | 29.30 | 1.139 | 1.150 | 1.153 |
| H1 | | 17.00 | | | 0.669 | |
| H2 | | 12.80 | | | 0.503 | |
| H3 | | 0.80 | | | 0.031 | |
| L (2) | 22.07 | 22.47 | 22.87 | 0.869 | 0.884 | 0.904 |
| L1 | 18.57 | 18.97 | 19.37 | 0.731 | 0.747 | 0.762 |
| L2 (2) | 15.50 | 15.70 | 15.90 | 0.610 | 0.618 | 0.626 |
| L3 | 7.70 | 7.85 | 7.95 | 0.303 | 0.309 | 0.313 |
| L4 | | 5 | | | 0.197 | |
| L5 | | 3.5 | | | 0.138 | |
| M | 3.70 | 4.00 | 4.30 | 0.145 | 0.157 | 0.169 |
| M1 | 3.60 | 4.00 | 4.40 | 0.142 | 0.157 | 0.173 |
| N | | 2.20 | | | 0.086 | |
| O | | 2 | | | 0.079 | |
| R | | 1.70 | | | 0.067 | |
| R1 | | 0.5 | | | 0.02 | |
| R2 | | 0.3 | | | 0.12 | |
| R3 | | 1.25 | | | 0.049 | |
| R4 | | 0.50 | | | 0.019 | |
| V | 5° (Typ.) | | | | | |
| V1 | 3° (Typ.) | | | | | |
| V2 | 20° (Typ.) | | | | | |
| V3 | 45° (Typ.) | | | | | |

(1): dam-bar protusion not included
(2): molding protusion included

OUTLINE AND MECHANICAL DATA



Flexiwatt27 (vertical)

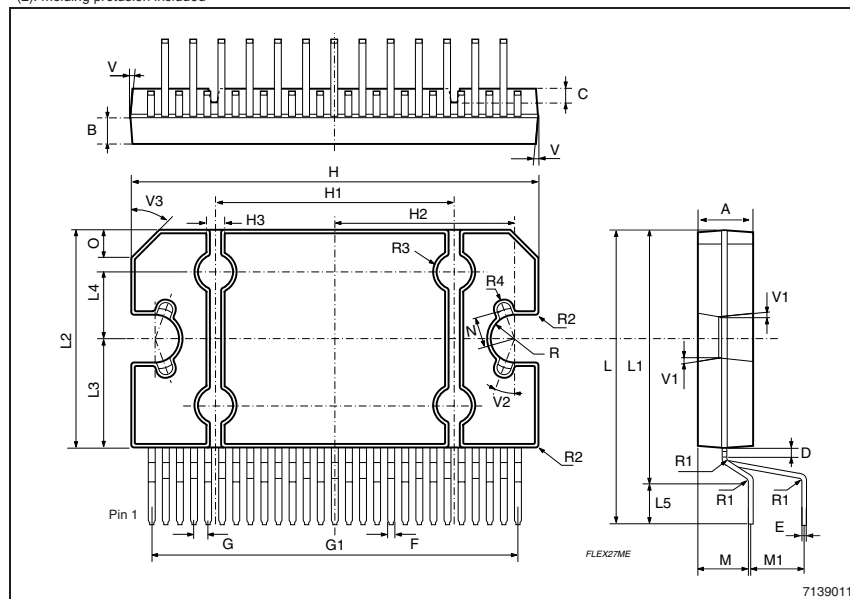


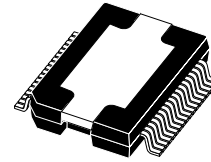
Figure 34. PowerSO36 (slug up) Mechanical Data & Package Dimensions

| DIM. | mm | | | inch | | |
|------|-------|-------|--------|--------|-------|---------|
| | MIN. | TYP. | MAX. | MIN. | TYP. | MAX. |
| A | 3.25 | | 3.43 | 0.128 | | 0.135 |
| A2 | 3.1 | | 3.2 | 0.122 | | 0.126 |
| A4 | 0.8 | | 1 | 0.031 | | 0.039 |
| A5 | | 0.2 | | | 0.008 | |
| a1 | 0.030 | | -0.040 | 0.0011 | | -0.0015 |
| b | 0.22 | | 0.38 | 0.008 | | 0.015 |
| c | 0.23 | | 0.32 | 0.009 | | 0.012 |
| D | 15.8 | | 16 | 0.622 | | 0.630 |
| D1 | 9.4 | | 9.8 | 0.37 | | 0.38 |
| D2 | | 1 | | | 0.039 | |
| E | 13.9 | | 14.5 | 0.547 | | 0.57 |
| E1 | 10.9 | | 11.1 | 0.429 | | 0.437 |
| E2 | | | 2.9 | | | 0.114 |
| E3 | 5.8 | | 6.2 | 0.228 | | 0.244 |
| E4 | 2.9 | | 3.2 | 0.114 | | 1.259 |
| e | | 0.65 | | | 0.026 | |
| e3 | | 11.05 | | | 0.435 | |
| G | 0 | | 0.075 | 0 | | 0.003 |
| H | 15.5 | | 15.9 | 0.61 | | 0.625 |
| h | | | 1.1 | | | 0.043 |
| L | 0.8 | | 1.1 | 0.031 | | 0.043 |
| N | | | 10° | | | 10° |
| s | | | 8° | | | 8° |

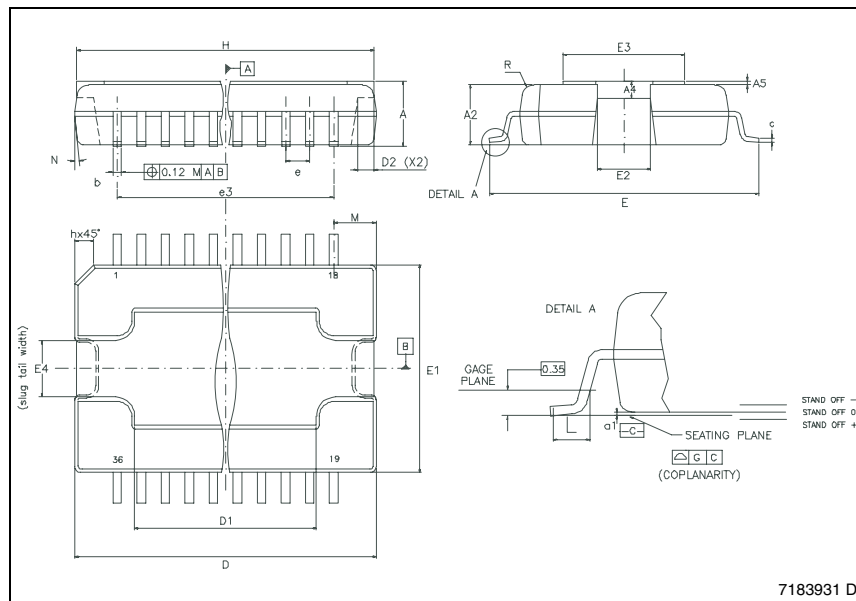
(1) "D and E1" do not include mold flash or protrusions.
Mold flash or protrusions shall not exceed 0.15mm (0.006")

(2) No intrusion allowed inwards the leads.

OUTLINE AND MECHANICAL DATA



PowerSO36 (SLUG UP)



11 Revision history

Table 12. Document revision history

| Date | Revision | Changes |
|-------------|----------|------------------|
| 05-Oct-2006 | 1 | Initial release. |

Please Read Carefully:

Information in this document is provided solely in connection with ST products. STMicroelectronics NV and its subsidiaries ("ST") reserve the right to make changes, corrections, modifications or improvements, to this document, and the products and services described herein at any time, without notice.

All ST products are sold pursuant to ST's terms and conditions of sale.

Purchasers are solely responsible for the choice, selection and use of the ST products and services described herein, and ST assumes no liability whatsoever relating to the choice, selection or use of the ST products and services described herein.

No license, express or implied, by estoppel or otherwise, to any intellectual property rights is granted under this document. If any part of this document refers to any third party products or services it shall not be deemed a license grant by ST for the use of such third party products or services, or any intellectual property contained therein or considered as a warranty covering the use in any manner whatsoever of such third party products or services or any intellectual property contained therein.

UNLESS OTHERWISE SET FORTH IN ST'S TERMS AND CONDITIONS OF SALE ST DISCLAIMS ANY EXPRESS OR IMPLIED WARRANTY WITH RESPECT TO THE USE AND/OR SALE OF ST PRODUCTS INCLUDING WITHOUT LIMITATION IMPLIED WARRANTIES OF MERCHANTABILITY, FITNESS FOR A PARTICULAR PURPOSE (AND THEIR EQUIVALENTS UNDER THE LAWS OF ANY JURISDICTION), OR INFRINGEMENT OF ANY PATENT, COPYRIGHT OR OTHER INTELLECTUAL PROPERTY RIGHT.

UNLESS EXPRESSLY APPROVED IN WRITING BY AN AUTHORIZED ST REPRESENTATIVE, ST PRODUCTS ARE NOT RECOMMENDED, AUTHORIZED OR WARRANTED FOR USE IN MILITARY, AIR CRAFT, SPACE, LIFE SAVING, OR LIFE SUSTAINING APPLICATIONS, NOR IN PRODUCTS OR SYSTEMS WHERE FAILURE OR MALFUNCTION MAY RESULT IN PERSONAL INJURY, DEATH, OR SEVERE PROPERTY OR ENVIRONMENTAL DAMAGE. ST PRODUCTS WHICH ARE NOT SPECIFIED AS "AUTOMOTIVE GRADE" MAY ONLY BE USED IN AUTOMOTIVE APPLICATIONS AT USER'S OWN RISK.

Resale of ST products with provisions different from the statements and/or technical features set forth in this document shall immediately void any warranty granted by ST for the ST product or service described herein and shall not create or extend in any manner whatsoever, any liability of ST.

ST and the ST logo are trademarks or registered trademarks of ST in various countries.

Information in this document supersedes and replaces all information previously supplied.

The ST logo is a registered trademark of STMicroelectronics. All other names are the property of their respective owners.

© 2006 STMicroelectronics - All rights reserved

STMicroelectronics group of companies

Australia - Belgium - Brazil - Canada - China - Czech Republic - Finland - France - Germany - Hong Kong - India - Israel - Italy - Japan - Malaysia - Malta - Morocco - Singapore - Spain - Sweden - Switzerland - United Kingdom - United States of America

www.st.com