

To all our customers

---

## **Regarding the change of names mentioned in the document, such as Mitsubishi Electric and Mitsubishi XX, to Renesas Technology Corp.**

---

The semiconductor operations of Hitachi and Mitsubishi Electric were transferred to Renesas Technology Corporation on April 1st 2003. These operations include microcomputer, logic, analog and discrete devices, and memory chips other than DRAMs (flash memory, SRAMs etc.) Accordingly, although Mitsubishi Electric, Mitsubishi Electric Corporation, Mitsubishi Semiconductors, and other Mitsubishi brand names are mentioned in the document, these names have in fact all been changed to Renesas Technology Corp. Thank you for your understanding. Except for our corporate trademark, logo and corporate statement, no changes whatsoever have been made to the contents of the document, and these changes do not constitute any alteration to the contents of the document itself.

Note : Mitsubishi Electric will continue the business operations of high frequency & optical devices and power devices.

Renesas Technology Corp.  
Customer Support Dept.  
April 1, 2003

# CR8PM

MEDIUM POWER USE  
INSULATED TYPE, GLASS PASSIVATION TYPE

**CR8PM**

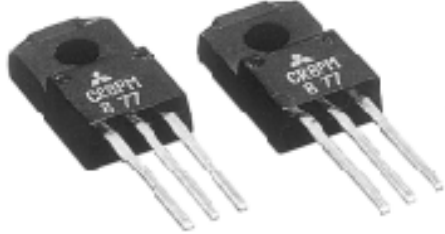

- $I_T$  (AV) ..... 8A
- $V_{DRM}$  ..... 400V/600V
- $I_{GT}$  ..... 15mA
- $V_{iso}$  ..... 1500V
- UL Recognized: File No. E80276

**OUTLINE DRAWING** Dimensions in mm

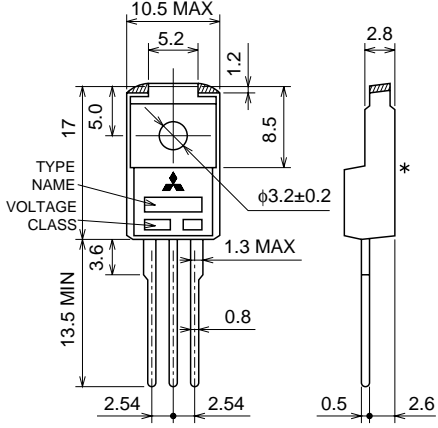

① CATHODE  
② ANODE  
③ GATE

TO-220F

\* Measurement point of case temperature

**APPLICATION**

Switching mode power supply, ECR, regulator for auticycle, motor control

**MAXIMUM RATINGS** ( $T_a=25^\circ\text{C}$ , unless otherwise noted)

Symbol	Parameter	Voltage class		Unit
		8	12	
VRRM	Repetitive peak reverse voltage	400	600	V
VRSM	Non-repetitive peak reverse voltage	500	720	V
VR (DC)	DC reverse voltage	320	480	V
VDRM	Repetitive peak off-state voltage	400	600	V
VD (DC)	DC off-state voltage	320	480	V

Symbol	Parameter	Conditions	Ratings	Unit
$I_T$ (RMS)	RMS on-state current		12.6	A
$I_T$ (AV)	Average on-state current	Commercial frequency, sine half wave, 180° conduction, $T_c=81^\circ\text{C}$	8.0	A
$I_{TSM}$	Surge on-state current	60Hz sine half wave 1 full cycle, peak value, non-repetitive	120	A
$I^2t$	$I^2t$ for fusing	Value corresponding to 1 cycle of half wave 60Hz, surge on-state current	60	A <sup>2</sup> s
PGM	Peak gate power dissipation		5.0	W
PG (AV)	Average gate power dissipation		0.5	W
VFGM	Peak gate forward voltage		6.0	V
VRGM	Peak gate reverse voltage		10	V
IFGM	Peak gate forward current		2.0	A
$T_j$	Junction temperature		-40 ~ +125	°C
$T_{stg}$	Storage temperature		-40 ~ +125	°C
—	Weight	Typical value	2.0	g
$V_{iso}$	Isolation voltage	$T_a=25^\circ\text{C}$ , AC 1 minute, each terminal to case	1500	V

**ELECTRICAL CHARACTERISTICS**

Symbol	Parameter	Test conditions	Limits			Unit
			Min.	Typ.	Max.	
IRRM	Repetitive peak reverse current	$T_j=125^{\circ}\text{C}$ , $V_{RRM}$ applied	—	—	2.0	mA
IDRM	Repetitive peak off-state current	$T_j=125^{\circ}\text{C}$ , $V_{DRM}$ applied	—	—	2.0	mA
V <sub>TM</sub>	On-state voltage	$T_c=25^{\circ}\text{C}$ , $I_{TM}=25\text{A}$ , instantaneous value	—	—	1.4	V
V <sub>GT</sub>	Gate trigger voltage	$T_a=25^{\circ}\text{C}$ , $V_D=6\text{V}$ , $I_T=1\text{A}$	—	—	1.0	V
V <sub>GD</sub>	Gate non-trigger voltage	$T_j=125^{\circ}\text{C}$ , $V_D=1/2V_{DRM}$	0.2	—	—	V
I <sub>GT</sub>	Gate trigger current	$T_j=25^{\circ}\text{C}$ , $V_D=6\text{V}$ , $I_T=1\text{A}$	—	—	15	mA
I <sub>H</sub>	Holding current	$T_j=25^{\circ}\text{C}$ , $V_D=12\text{V}$	—	1.5	—	mA
R <sub>th(j-c)</sub>	Thermal resistance	Junction to case *1	—	—	3.7	$^{\circ}\text{C}/\text{W}$

\*1. The contact thermal resistance R<sub>th(j-c)</sub> is 0.5 $^{\circ}\text{C}/\text{W}$  with greased.

**PERFORMANCE CURVES**

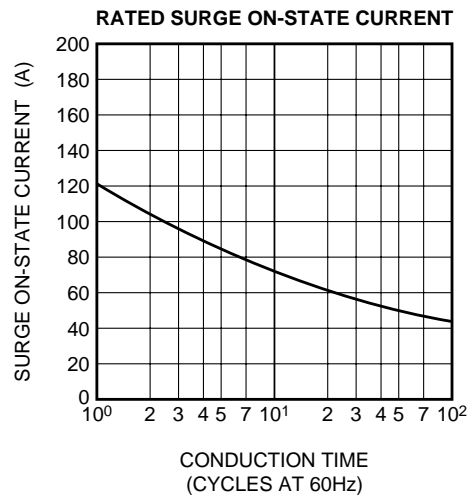
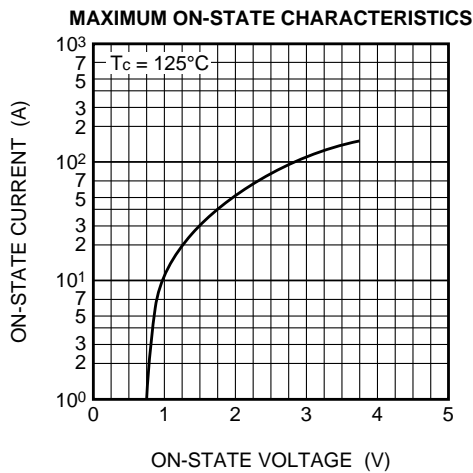

# CR8PM

MEDIUM POWER USE  
INSULATED TYPE, GLASS PASSIVATION TYPE

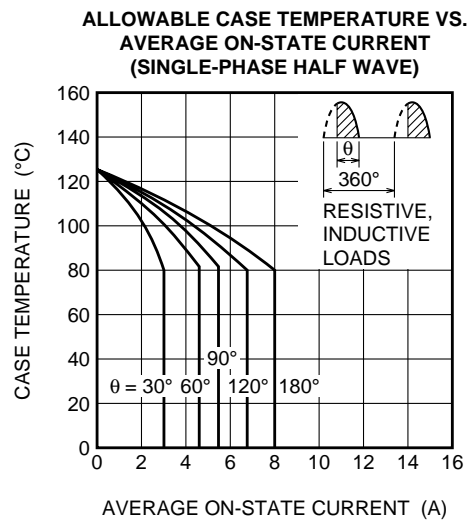
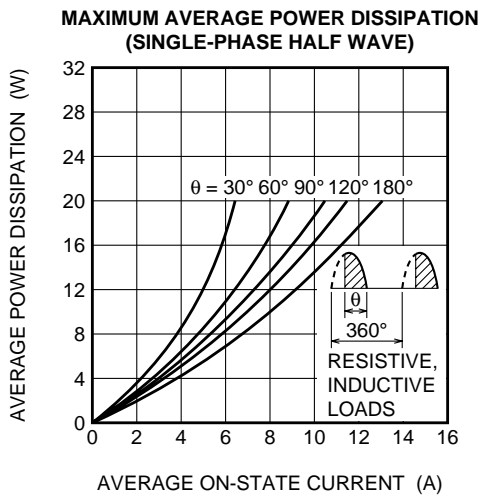
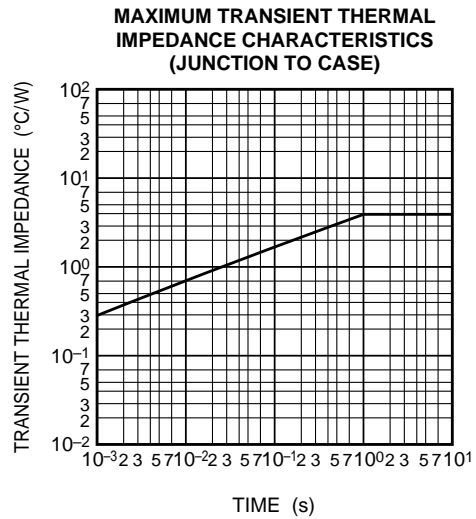
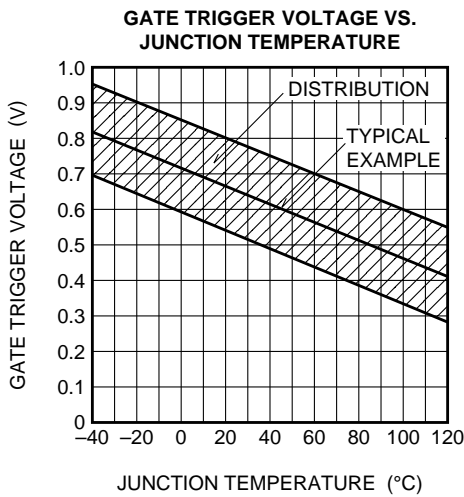
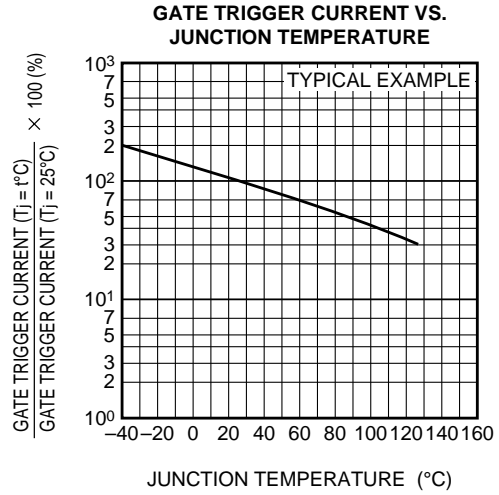
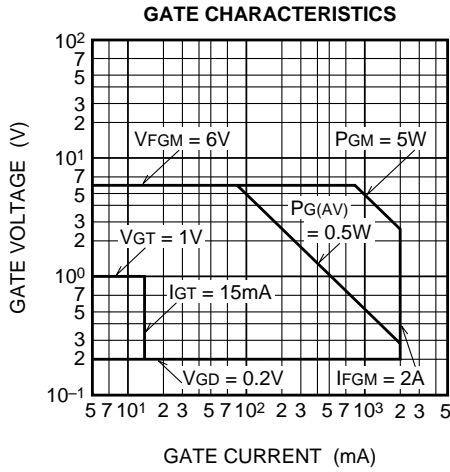

# CR8PM

MEDIUM POWER USE  
INSULATED TYPE, GLASS PASSIVATION TYPE

**MAXIMUM AVERAGE POWER DISSIPATION  
(SINGLE-PHASE FULL WAVE)**

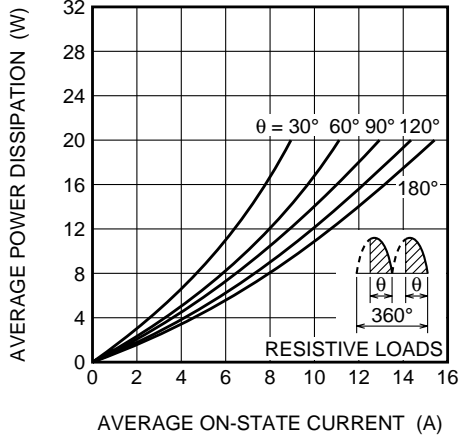

**ALLOWABLE CASE TEMPERATURE VS.  
AVERAGE ON-STATE CURRENT  
(SINGLE-PHASE FULL WAVE)**

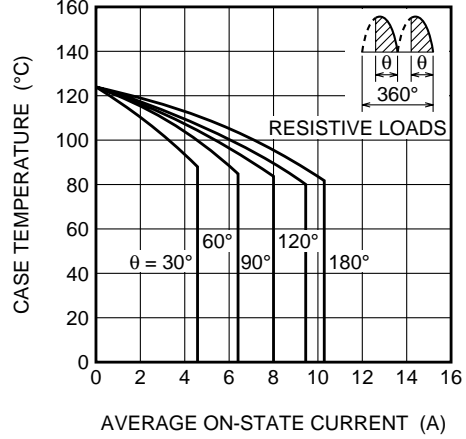

**MAXIMUM AVERAGE POWER DISSIPATION  
(RECTANGULAR WAVE)**

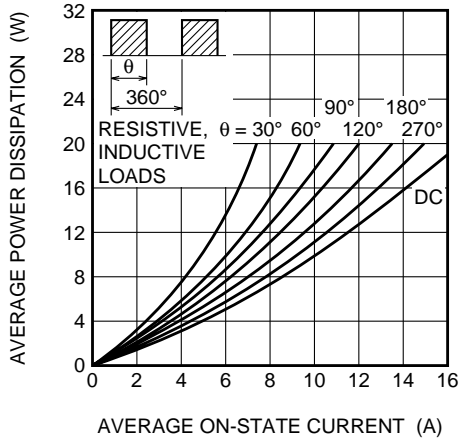

**ALLOWABLE CASE TEMPERATURE VS.  
AVERAGE ON-STATE CURRENT  
(RECTANGULAR WAVE)**

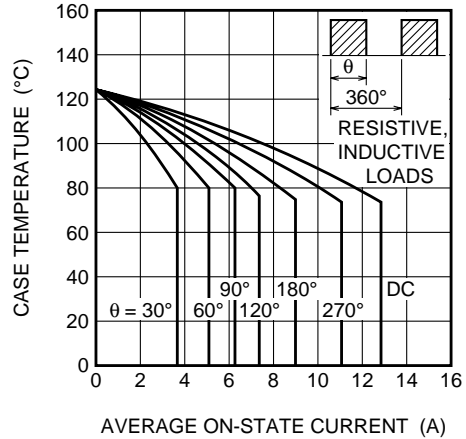

**BREAKOVER VOLTAGE VS.  
JUNCTION TEMPERATURE**

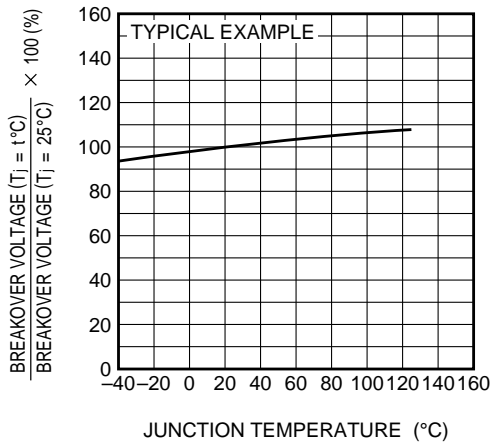

**BREAKOVER VOLTAGE VS.  
RATE OF RISE OF OFF-STATE VOLTAGE**

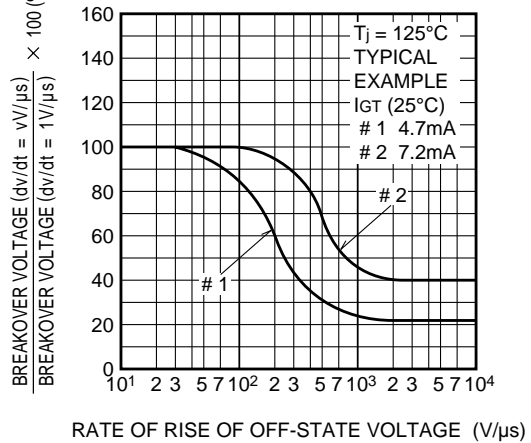

**CR8PM**

MEDIUM POWER USE  
INSULATED TYPE, GLASS PASSIVATION TYPE

**HOLDING CURRENT VS. JUNCTION TEMPERATURE**

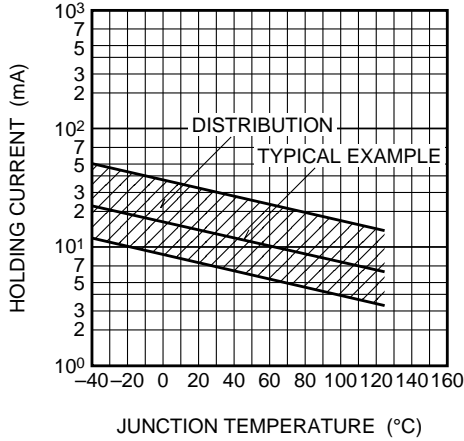

**HOLDING CURRENT VS. GATE TRIGGER CURRENT**

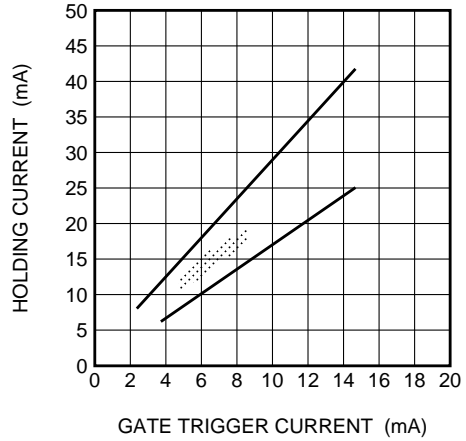

**TURN-ON TIME VS. GATE CURRENT**

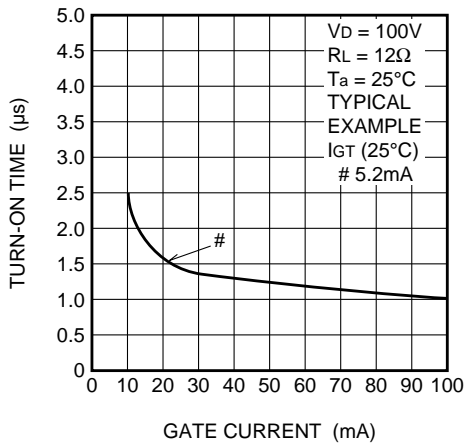

**TURN-OFF TIME VS. JUNCTION TEMPERATURE**

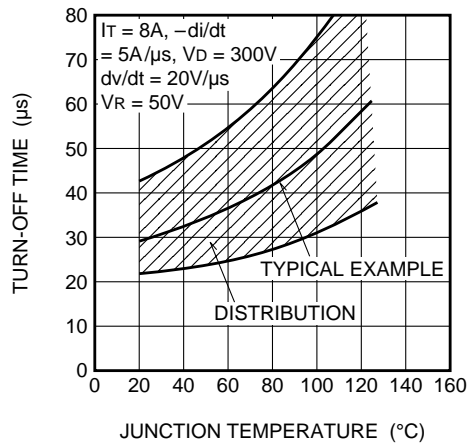

**REPETITIVE PEAK REVERSE VOLTAGE VS. JUNCTION TEMPERATURE**

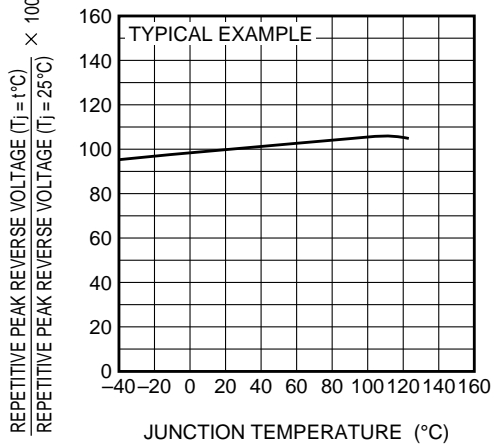

**GATE TRIGGER CURRENT VS. GATE CURRENT PULSE WIDTH**

