



Features

- Automatic power-down when deselected
- CMOS for optimum speed/power
- High speed
— 25 ns
- Low active power
— 440 mW (commercial)
— 605 mW (military)
- Low standby power
— 55 mW
- TTL-compatible inputs and outputs
- Capable of withstanding greater than 2001V electrostatic discharge

Functional Description

The CY7C147 is a high-performance CMOS static RAMs organized as 4096 words by 1 bit. Easy memory expansion is provided by an active LOW chip enable (CE) and three-state drivers. The CY7C147 has an automatic power-down feature, reducing the power consumption by 80% when deselected.

Writing to the device is accomplished when the chip select (CE) and write enable (WE) inputs are both LOW. Data on the input pin (DI) is written into the memory loca-

tion specified on the address pins (A₀ through A₁₁).

Reading the device is accomplished by taking the chip enable (CE) LOW while (WE) remains HIGH. Under these conditions, the contents of the locations specified on the address pins will appear on the data output (DO) pin.

The output pin remains in a high-impedance state when chip enable is HIGH, or write enable (WE) is LOW.

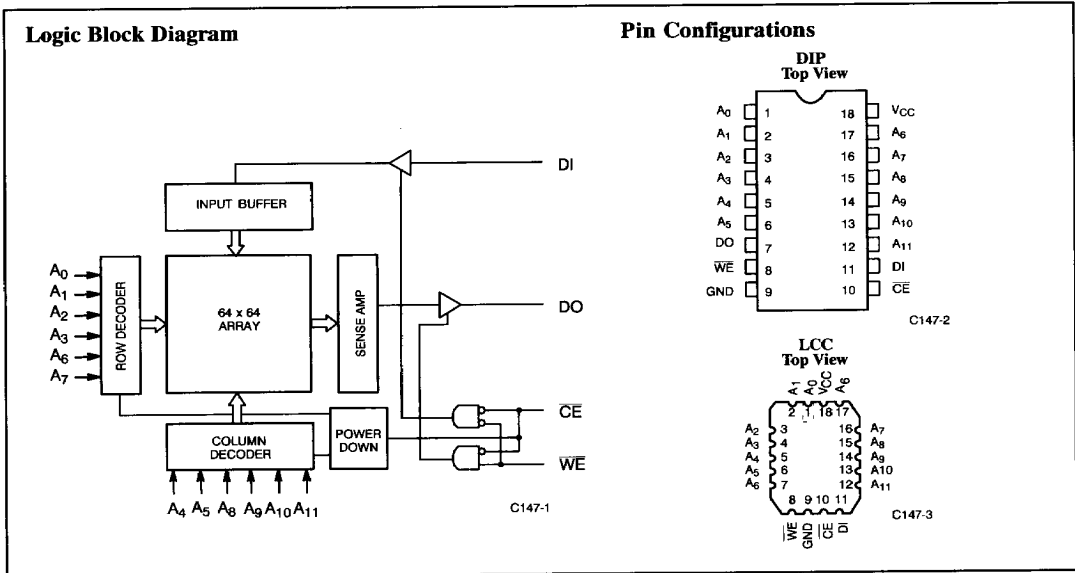

Selection Guide

			7C147-25	7C147-35	7C147-45
Maximum Access Time (ns)	Commercial		25	35	45
	Military			35	45
Maximum Operating Current (mA)	Commercial	90	80	110	110
	Military				
Maximum Standby Current (mA)	Commercial	15	10	10	10
	Military			10	10

Maximum Ratings

(Above which the useful life may be impaired. For user guidelines, not tested.)

Storage Temperature	- 65°C to +150°C
Ambient Temperature with Power Applied	- 55°C to +125°C
Supply Voltage to Ground Potential (Pin 18 to Pin 9)	- 0.5V to +7.0V
DC Voltage Applied to Outputs in High Z State	- 0.5V to +7.0V
DC Input Voltage	- 3.0V to +7.0V

Output Current into Outputs (LOW)	20 mA
Static Discharge Voltage (per MIL-STD-883, Method 3015)	>2001V
Latch-Up Current	>200 mA

Operating Range

Range	Ambient Temperature	V _{CC}
Commercial	0°C to +70°C	5V ± 10%
Military ^[1]	- 55°C to +125°C	5V ± 10%

Electrical Characteristics Over the Operating Range^[2]

Parameters	Description	Test Conditions	7C147-25		7C147-35,45		Units
			Min.	Max.	Min.	Max.	
V _{OH}	Output High Voltage	V _{CC} = Min., I _{OH} = -4.0 mA	2.4		2.4		V
V _{OL}	Output Low Voltage	V _{CC} = Min., I _{OL} = 12.0 mA		0.4		0.4	V
V _{IH}	Input High Voltage		2.0	6.0	2.0	6.0	V
V _{IL}	Input Low Voltage		-3.0	0.8	-3.0	0.8	V
I _{Ix}	Input Load Current	GND ≤ V _I ≤ V _{CC}	-10	+10	-10	+10	μA
I _{OZ}	Output Leakage Current	GND ≤ V _O ≤ V _{CC} Output Disabled	-50	+50	-50	+50	μA
I _{OS}	Output Short Circuit Current ^[3]	V _{CC} = Max., V _{OUT} = GND		-350		-350	mA
I _{CC}	V _{CC} Operating Supply Current	V _{CC} = Max., I _{OUT} = 0 mA	Com'l	90		80	mA
			Mil			110	
I _{SB}	Automatic CE ^[4] Power-Down Current	Max. V _{CC} , CE ≥ V _{IH}	Com'l	15		10	mA
			Mil			10	

Capacitance^[5]

Parameters	Description	Test Conditions	Max.	Units
C _{IN}	Input Capacitance	T _A = 25°C, f = 1 MHz, V _{CC} = 5.0V	8	pF
C _{OUT}	Output Capacitance		8	pF

Notes:

1. T_A is the "instant on" case temperature.
2. See the last page of this specification for Group A subgroup testing information.
3. Duration of the short circuit should not exceed 30 seconds.
4. A pull-up resistor to V_{CC} on the \overline{CE} input is required to keep the device deselected during V_{CC} power-up, otherwise I_{SB} will exceed values given.
5. Tested initially and after any design or process changes that may affect these parameters.

AC Test Loads and Waveforms

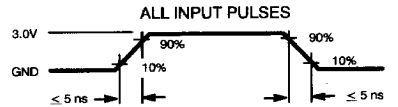
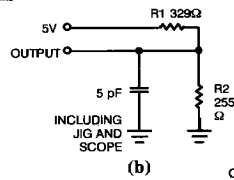
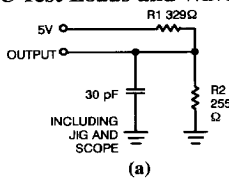

C147-5

Equivalent to: THEVENIN EQUIVALENT

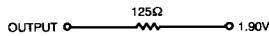

C147-4

Switching Characteristics Over the Operating Range^[6]

Parameters	Description	7C147-25		7C147-35		7C147-45		Units
		Min.	Max.	Min.	Max.	Min.	Max.	
READ CYCLE								
t _{RC}	Read Cycle Time	25		35		45		ns
t _{AA}	Address to Data Valid		25		35		45	ns
t _{OHA}	Data Hold from Address Change	3		5		5		ns
t _{ACE}	\overline{CE} LOW to Data Valid		25		35		45	ns
t _{LZCE}	\overline{CE} LOW to Low Z ^[7]	5		5		5		ns
t _{HZCE}	\overline{CE} HIGH to High Z ^[7,8]		20		30		30	ns
t _{PU}	\overline{CE} LOW to Power-Up	0		0		0		ns
t _{PD}	\overline{CE} HIGH to Power-Down		20		20		20	ns
WRITE CYCLE^[9]								
t _{WC}	Write Cycle Time	25		35		45		ns
t _{SCE}	CE LOW to Write End	25		35		45		ns
t _{AW}	Address Set-Up to Write End	25		35		45		ns
t _{HA}	Address Hold from Write End	0		0		0		ns
t _{SA}	Address Set-Up to Write Start	0		0		0		ns
t _{PWE}	WE Pulse Width	15		20		25		ns
t _{SD}	Data Set-Up to Write End	15		20		25		ns
t _{HD}	Data Hold from Write End	0		10		10		ns
t _{LZWE}	WE HIGH to Low Z ^[7]	0		0		0		ns
t _{HZWE}	\overline{WE} LOW to High Z ^[7,8]		15		20		25	ns

Notes:

- Test conditions assume signal transition times of 5 ns or less, timing reference levels of 1.5V, input pulse levels of 0 to 3.0V, and output loading of the specified I_{OL}/I_{OH} and 30-pF load capacitance.
- At any given temperature and voltage condition, t_{HZ} is less than t_{LZ} for all devices.
- t_{HZCE} and t_{HZWE} are tested with C_L = 5 pF as in part (b) of AC Test Loads. Transition is measured ±500 mV from steady state voltage.
- The internal write time of the memory is defined by the overlap of \overline{CE} LOW and WE LOW. Both signals must be LOW to initiate a write and either signal can terminate a write by going HIGH. The data input set-up and hold timing should be referenced to the rising edge of the signal that terminates the write.

Switching Waveforms

Read Cycle No. 1^[10, 11]

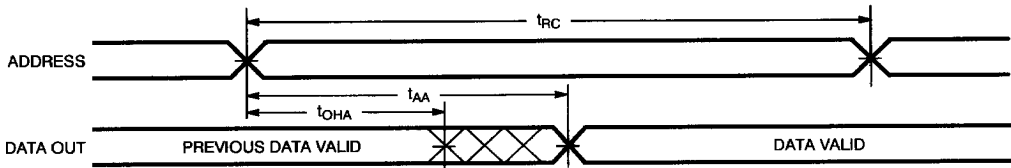

C147-6

Read Cycle No. 2^[10, 12]

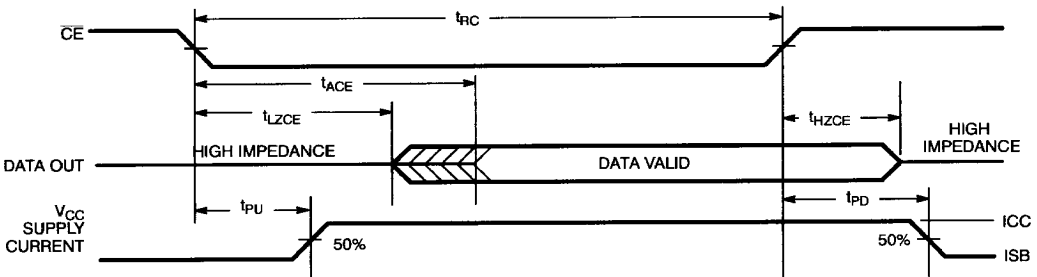

C147-7

Write Cycle No. 1 (\overline{WE} Controlled)^[9]

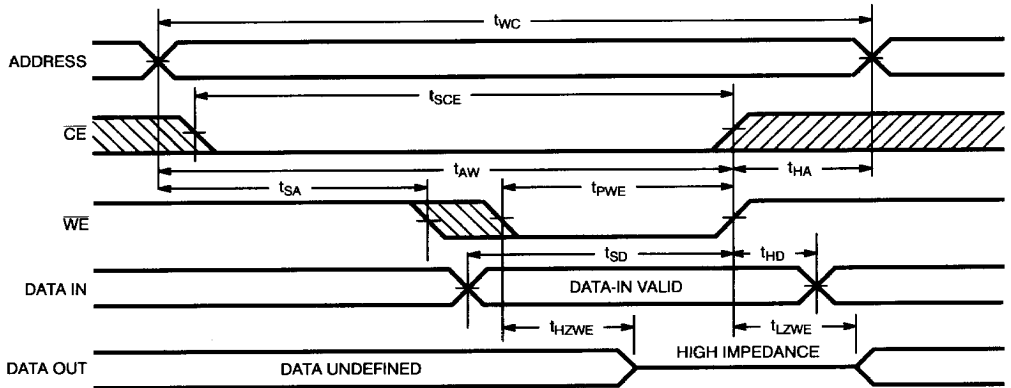

C147-8

Notes:

- 10. \overline{WE} is HIGH for read cycle.
- 11. Device is continuously selected, $\overline{CE} = V_{IL}$.
- 12. Address valid prior to or coincident with \overline{CE} transition LOW.

Switching Waveforms (continued)

Write Cycle No. 2 (\overline{CE} Controlled)^[9, 13]

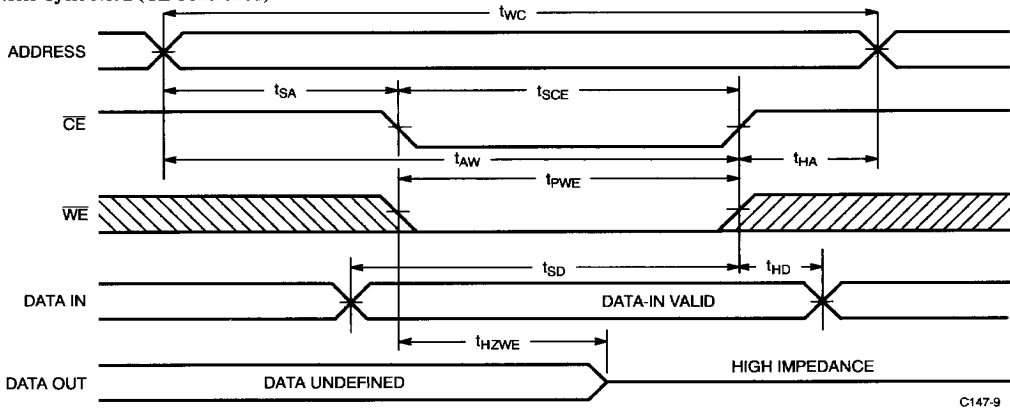

C147-9

Notes:

13. If \overline{CE} goes HIGH simultaneously with \overline{WE} HIGH, the output remains in a high-impedance state.

Typical DC and AC Characteristics

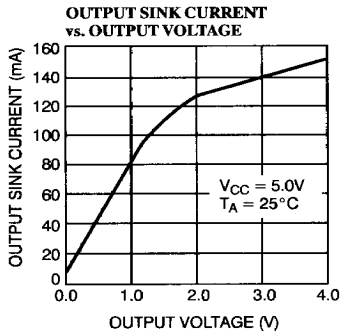
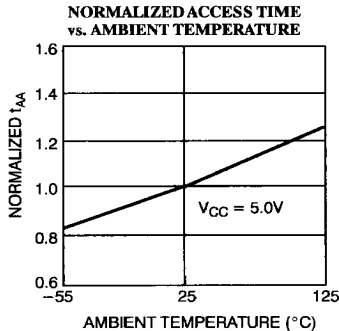
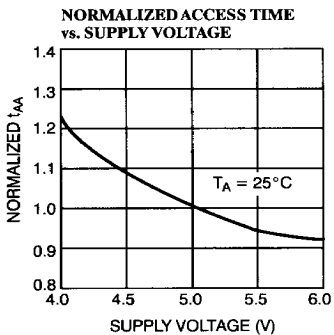
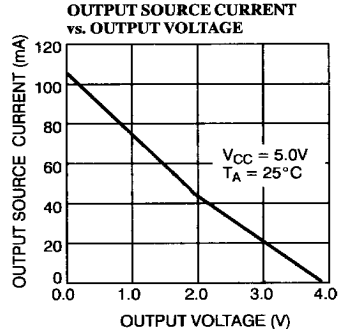
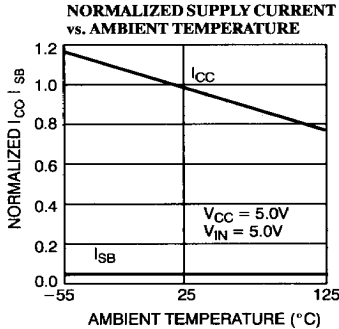
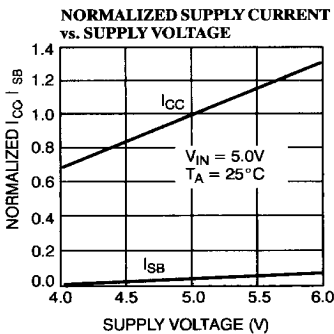

Typical DC and AC Characteristics (continued)

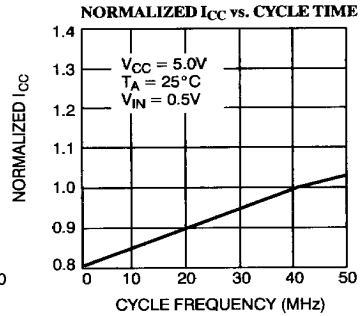
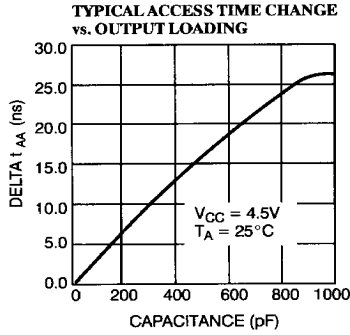
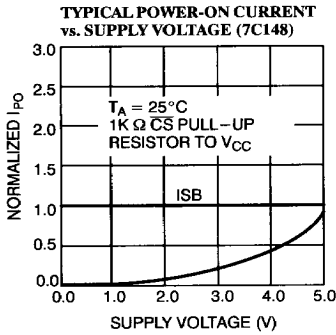

Ordering Information

Speed (ns)	Ordering Code	Package Type	Operating Range
25	CY7C147-25PC	P3	Commercial
	CY7C147-25DC	D4	
	CY7C147-25LC	L50	
35	CY7C147-35PC	P3	Commercial
	CY7C147-35DC	D4	
	CY7C147-35LC	L50	
	CY7C147-35DMB	D4	Military
	CY7C147-35KMB	K70	
	CY7C147-35LMB	L50	
45	CY7C147-45PC	P3	Commercial
	CY7C147-45DC	D4	
	CY7C147-45LC	L50	
	CY7C147-45DMB	D4	Military
	CY7C147-45KMB	K70	
	CY7C147-45LMB	L50	

MILITARY SPECIFICATIONS
Group A Subgroup Testing

DC Characteristics

Parameters	Subgroups
V _{OH}	1,2,3
V _{OL}	1,2,3
V _{IH}	1,2,3
V _{IL Max.}	1,2,3
I _{IX}	1,2,3
I _{OZ}	1,2,3
I _{CC}	1,2,3
I _{SB}	1,2,3

Switching Characteristics

Parameters	Subgroups
READ CYCLE	
t _{RC}	7,8,9,10,11
t _{AA}	7,8,9,10,11
t _{OHA}	7,8,9,10,11
t _{ACE}	7,8,9,10,11
WRITE CYCLE	
t _{WC}	7,8,9,10,11
t _{SCE}	7,8,9,10,11
t _{AW}	7,8,9,10,11
t _{HA}	7,8,9,10,11
t _{SA}	7,8,9,10,11
t _{PWE}	7,8,9,10,11
t _{SD}	7,8,9,10,11
t _{HD}	7,8,9,10,11

Document #: 38-00030-B