

Features

- Low On-Resistance
 - 70mΩ @V_{GS} = 4.5V
 - 100mΩ @V_{GS} = 2.5V
 - 170mΩ @V_{GS} = 1.5V
- Very Low Gate Threshold Voltage
- Low Input Capacitance
- Fast Switching Speed
- **Lead, Halogen and Antimony Free, RoHS Compliant "Green" Device (Notes 2, 3 and 6)**
- **Qualified to AEC-Q101 Standards for High Reliability**
- **ESD Protected Gate**

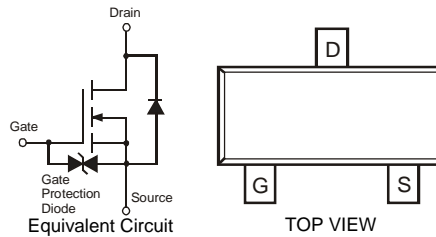

SOT-23



Maximum Ratings @T_A = 25°C unless otherwise specified

Characteristic	Symbol	Value	Units
Drain-Source Voltage	V _{DSS}	20	V
Gate-Source Voltage	V _{GSS}	±12	V
Drain Current (Note 1)	I _D	2.3	A
Pulsed Drain Current (Note 4)	I _{DM}	8	A

Thermal Characteristics

Characteristic	Symbol	Value	Units
Total Power Dissipation (Note 1)	P _D	600	mW
Thermal Resistance, Junction to Ambient	R _{θJA}	208	°C/W
Operating and Storage Temperature Range	T _J , T _{STG}	-55 to +150	°C

Electrical Characteristics @T_A = 25°C unless otherwise specified

Characteristic	Symbol	Min	Typ	Max	Unit	Test Condition
OFF CHARACTERISTICS (Note 5)						
Drain-Source Breakdown Voltage	BV _{DSS}	20	28	—	V	V _{GS} = 0V, I _D = 10μA
Zero Gate Voltage Drain Current	I _{DSS}	—	—	1	μA	V _{DS} = 20V, V _{GS} = 0V
Gate-Source Leakage	I _{GSS}	—	—	±10	μA	V _{GS} = ±12V, V _{DS} = 0V
ON CHARACTERISTICS (Note 5)						
Gate Threshold Voltage	V _{GS(th)}	0.45	—	1.0	V	V _{DS} = V _{GS} , I _D = 250μA
Static Drain-Source On-Resistance	R _{DS(ON)}	—	50	70	mΩ	V _{GS} = 4.5V, I _D = 3A
		—	70	100		V _{GS} = 2.5V, I _D = 2.3A
		—	125	170		V _{GS} = 1.5V, I _D = 0.5A
Forward Transfer Admittance	Y _{fs}	—	6	—	S	V _{DS} = 5V, I _D = 2.4A
Diode Forward Voltage (Note 5)	V _{SD}	—	0.7	0.9	V	V _{GS} = 0V, I _S = 1.05A
DYNAMIC CHARACTERISTICS						
Input Capacitance	C _{iss}	—	217	—	pF	V _{DS} = 10V, V _{GS} = 0V f = 1.0MHz
Output Capacitance	C _{oss}	—	62	—	pF	
Reverse Transfer Capacitance	C _{rss}	—	34	—	pF	

- Notes:
1. Device mounted on FR-4 PCB, on minimum recommended, 2oz Copper pad layout.
 2. No purposefully added lead. Halogen and Antimony Free.
 3. Diodes Inc.'s "Green" policy can be found on our website at http://www.diodes.com/products/lead_free/index.php.
 4. Repetitive rating, pulse width limited by junction temperature.
 5. Short duration pulse test used to minimize self-heating effect.
 6. Product manufactured with Green Molding Compound and does not contain Halogens or Sb₂O₃ Fire Retardants.

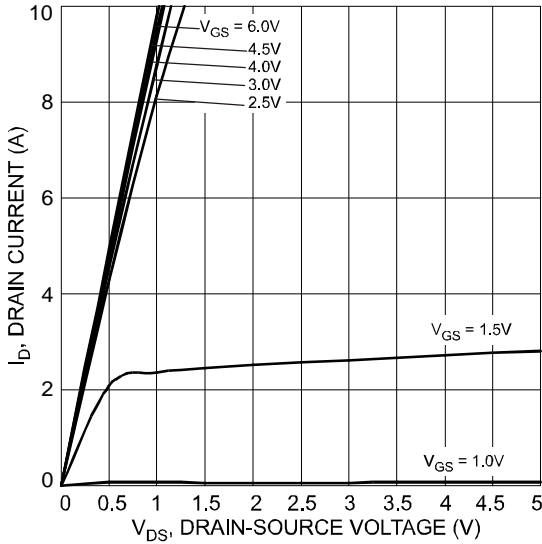

Fig. 1 Typical Output Characteristic

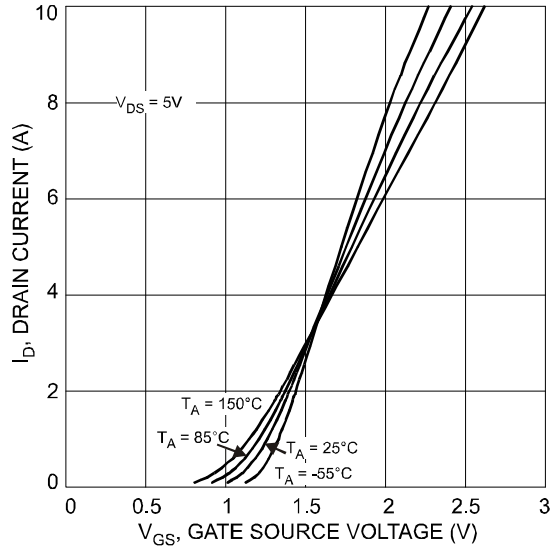

Fig. 2 Typical Transfer Characteristics

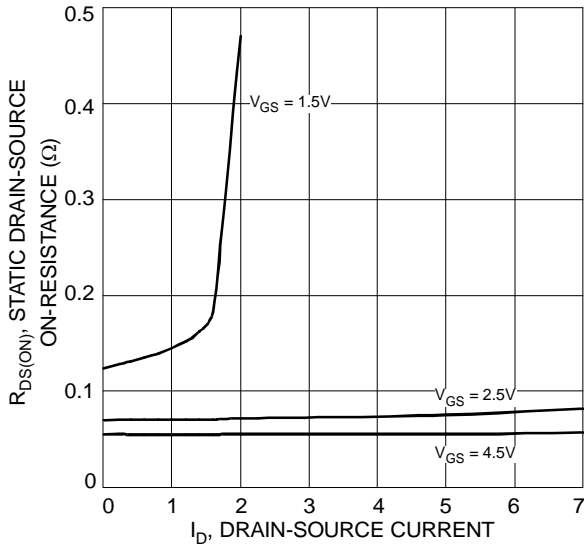

Fig. 3 On-Resistance vs. Drain-Source Current & Gate Voltage

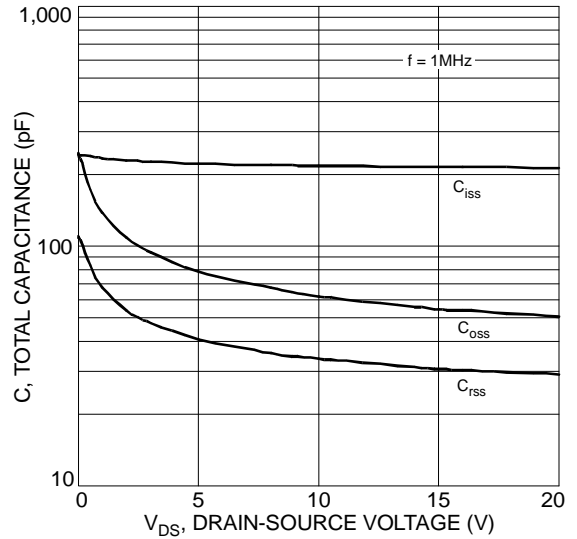

Fig. 4 Typical Total Capacitance

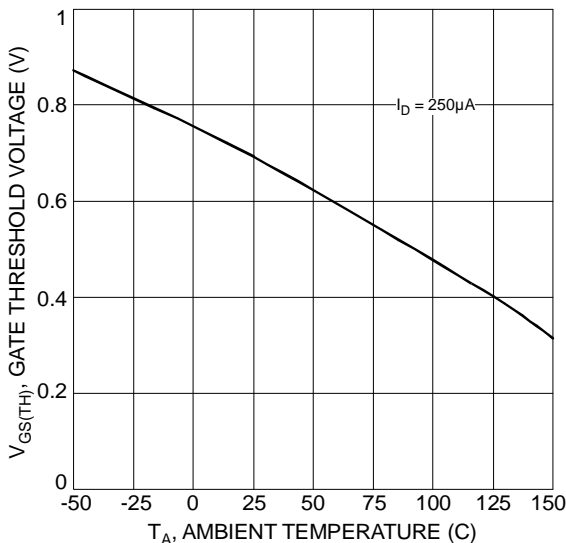

Fig. 5 Gate Threshold Variation with Ambient Temperature

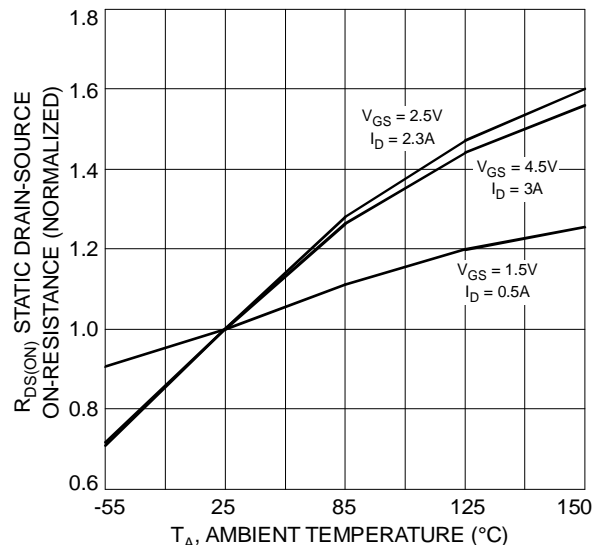

Fig. 6 Normalized Static Drain-Source On-Resistance vs. Ambient Temperature

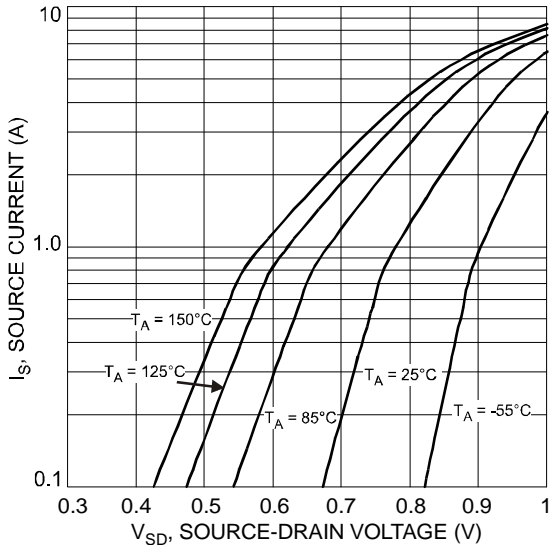

Fig. 7 Reverse Drain Current vs. Source-Drain Voltage

Ordering Information (Note 7)

Part Number	Case	Packaging
DMN2170U-7	SOT-23	3000/Tape & Reel

Notes: 7. For packaging details, go to our website at <http://www.diodes.com/datasheets/ap02007.pdf>.

Marking Information

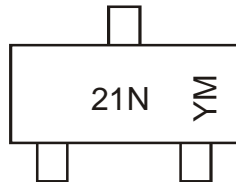

21N = Marking Code
 YM = Date Code Marking
 Y = Year ex: U = 2007
 M = Month ex: 9 = September

Date Code Key (If Applicable)

Year	2007	2008	2009	2010	2011	2012
Code	U	V	W	X	Y	Z

Month	Jan	Feb	Mar	Apr	May	Jun	Jul	Aug	Sep	Oct	Nov	Dec
Code	1	2	3	4	5	6	7	8	9	O	N	D

Package Outline Dimensions

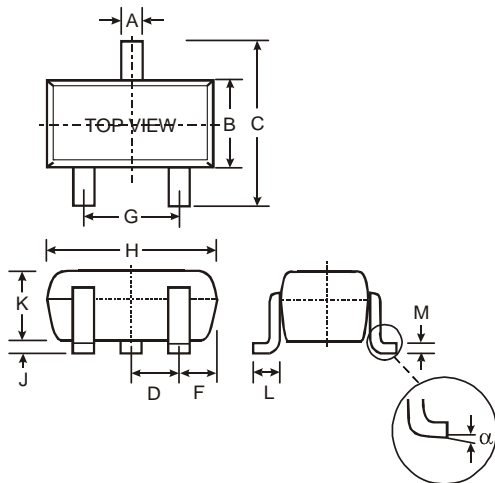

SOT-23		
Dim	Min	Max
A	0.37	0.51
B	1.20	1.40
C	2.30	2.50
D	0.89	1.03
F	0.45	0.60
G	1.78	2.05
H	2.80	3.00
J	0.013	0.10
K	0.903	1.10
L	0.45	0.61
M	0.085	0.180
α	0°	8°
All Dimensions in mm		

Suggested Pad Layout

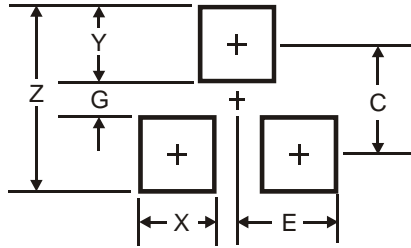

Dimensions	Value (in mm)
Z	3.4
G	0.7
X	0.9
Y	1.4
C	2.0
E	0.9

IMPORTANT NOTICE

Diodes Incorporated and its subsidiaries reserve the right to make modifications, enhancements, improvements, corrections or other changes without further notice to any product herein. Diodes Incorporated does not assume any liability arising out of the application or use of any product described herein; neither does it convey any license under its patent rights, nor the rights of others. The user of products in such applications shall assume all risks of such use and will agree to hold Diodes Incorporated and all the companies whose products are represented on our website, harmless against all damages.

LIFE SUPPORT

Diodes Incorporated products are not authorized for use as critical components in life support devices or systems without the expressed written approval of the President of Diodes Incorporated.

NEW PRODUCT