

Features

- High collector-emitter voltage ($V_{CE0}=70V$)
- High input-output isolation voltage: ($V_{iso} : 5,000V_{rms}$)
- Directly connectable to TTL
- UL approved (No. E113898)
- TUV approved (No.R9653630)
- CSA approved (No. CA91533-1)
- FIMKO approved (No. 193422)
- NEMKO approved (No. P96103013)
- DEMKO approved (No. 303968)
- SEMKO approved (No. 9646047/01-30)
- VDE approved (No. 094722)
- Options available :
 - Leads with 0.4"(10.16mm)spacing (M Type)
 - Leads bends for surface mounting(S Type)
 - Tape and Reel of Type I for SMD(Add"-TA"Suffix)
 - Tape and Reel of Type II for SMD(Add"-TA1"Suffix)
 - VDE 0884 approvals (Add"-V"Suffix)

Applications

1. Telephone sets, telephone exchangers.
2. System appliances, measuring instruments.
3. Signal transmission between circuits of different potentials and impedances.

Package Dimensions

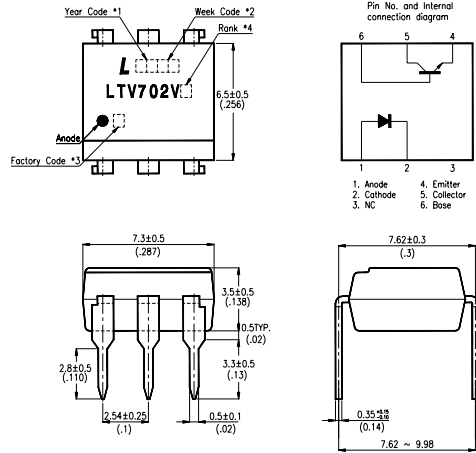

Note:

1. Year date code.
2. 2-digit work week.
3. Factory code shall be marked (Z : Taiwan, Y : Thailand).
4. Rank shall be or shall not be marked.
5. All dimensions are in millimeters (inches).
6. Tolerance is $\pm 0.25mm$ (.010") unless otherwise noted.
7. Specifications are subject to change without notice.

Ordering Information

Part Number	Package	Safety Standard Approval	Application part number
LTV-702V LTV-702VM LTV-702VS LTV-702VS-TA LTV-702VS-TA1	6-pin DIP 6-pin (leads with 0.4" spacing) 6-pin (lead bends for surface mount) 6-pin (tape and reel packaging of type I) 6-pin (tape and reel packaging of type II)	<ul style="list-style-type: none"> • UL approved • TUV approved • CSA approved • FIMKO approved • NEMKO approved • SEMKO approved • DEMKO approved 	LTV - 702V
LTV702V-V LTV702VM-V LTV702VS-V LTV702VSTA-V LTV702VSTA1-V	6-pin DIP 6-pin (leads with 0.4" spacing) 6-pin (lead bends for surface mount) 6-pin (tape and reel packaging of type I) 6-pin (tape and reel packaging of type II)	<ul style="list-style-type: none"> • VDE approved 	LTV - 702V

Absolute Maximum Ratings

(Ta=25°C)

Parameter		Symbol	Rating	Unit
Input	Forward Current	I _F	60	mA
	Reverse Voltage	V _R	6	V
	Power Dissipation	P	105	mW
Output	Collector-Emitter Voltage	V _{CEO}	70	V
	Emitter-Collector Voltage	V _{ECO}	6	V
	Collector Current	I _C	50	mA
	Collector Power Dissipation	P _C	160	mW
	Collector-Base Voltage	V _{CBO}	70	V
	Emitter-Base Voltage	V _{EBO}	6	V
Total Power Dissipation		P _{tot}	200	mW
Operating Temperature		T _{opr}	-55~+100	°C
Storage Temperature		T _{stg}	-55~+150	°C
*1.Isolation Voltage		V _{iso}	5	KV _{rms}
*2.Soldering Temperature		T _{sol}	260	°C

*1. AC for 1 minute, R.H. = 40 ~ 60%

• Isolation voltage shall be measured using the following method.

(1) Short between anode and cathode on the primary side and between collector, emitter and base on the secondary side.

(2) The isolation voltage tester with zero-cross circuit shall be used.

(3) The waveform of applied voltage shall be a sine wave.

*2. For 10 seconds.

Electrical/Optical Characteristics

(Ta=25°C)

Parameter		Symbol	Min.	Typ.	Max.	Unit	Conditions
Input	Forward Voltage	V _F	—	1.4	1.7	V	I _F =60mA
	Reverse Current	I _R	—	—	10	μA	V _R =6V
	Terminal Capacitance	C _t	—	30	250	pF	V=0, f=1KHz
Output	Collector Dark Current	I _{CEO}	—	—	50	nA	V _{CE} =10V
	Collector-Emitter Breakdown Voltage	BV _{CEO}	70	—	—	V	I _C =0.1mA
	Emitter-Collector Breakdown Voltage	BV _{ECO}	6	—	—	V	I _E =10 μA
	Collector-Base Breakdown Voltage	BV _{CBO}	70	—	—	V	I _C =0.1mA
Transfer Characteristics	Collector Current	I _C	4	—	32	mA	I _F =10mA V _{CE} =5V
	*Current Transfer Ratio	CTR	40	—	320	%	I _F =10mA V _{CE} =5V
	Collector-emitter Saturation Voltage	V _{CE(sat)}	—	0.25	0.4	V	I _F =10mA, I _C =2.5mA
	Isolation Resistance	R _{iso}	5 × 10 ¹⁰	10 ¹¹	—	Ω	DC500V, 40~60% R.H.
	Floating Capacitance	C _f	—	0.6	1.0	pF	V=0, f=1MHz
	Cut-off Frequency	f _c	—	150	—	KHz	V _{CC} =5V, I _F =10mA R _L =75 Ω, -3dB
	Response Time (Rise)	t _r	—	2	7	μs	V _{CC} =5V, I _F =10mA
Response Time (Fall)	t _f	—	2	8	μs	R _L =75 Ω	

$$*CTR = \frac{I_C}{I_F} \times 100\%$$

■ Supplement

Rank Table of Current Transfer Ratio CTR

Model No.	Rank Mark	CTR(%)
LTV-702V	A	40~80
LTV-702V	B	63~125
LTV-702V	C	100~200
LTV-702V	D	160~320
LTV-702V	A or B or C or D	40~320
Conditions	$I_F=10\text{mA}$ $V_{CE}=5\text{V}$ $T_a=25^\circ\text{C}$	

Typical Electrical/Optical Characteristic Curves (25°C Ambient Temperature Unless Otherwise Noted)

Fig.1 Forward Current vs. Ambient Temperature

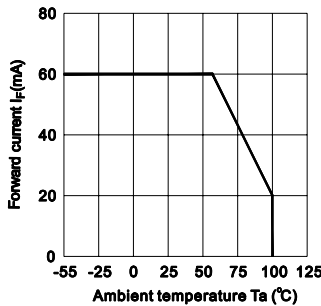

Fig.2 Collector Power Dissipation vs. Ambient Temperature

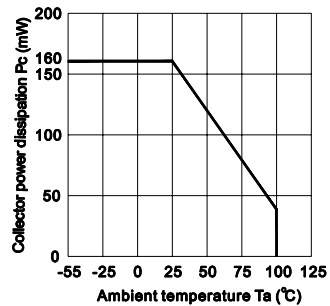

Fig.3 Frequency Response

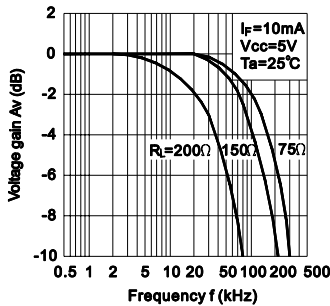

Fig.4 Forward Current vs. Forward Voltage

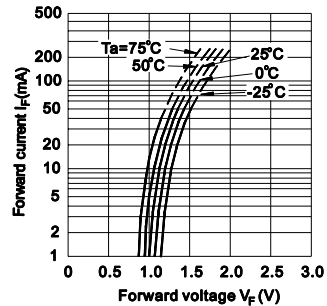

Fig.5 Current Transfer Ratio vs. Forward Current

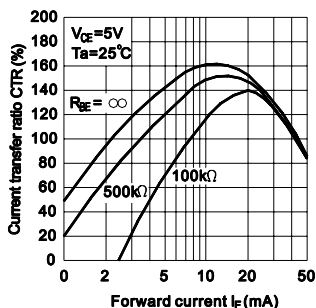

Fig.6 Collector Current vs. Collector-emitter Voltage

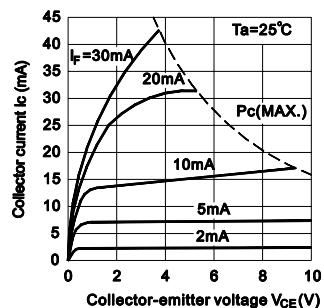

Fig.7 Relative Current Transfer Ratio vs. Ambient Temperature

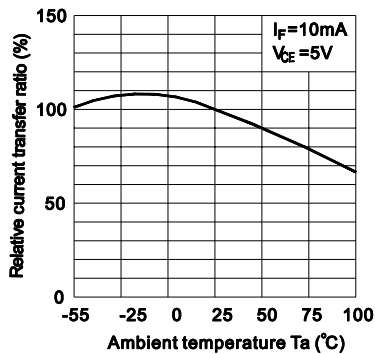

Fig.8 Collector-emitter Saturation Voltage vs. Ambient Temperature

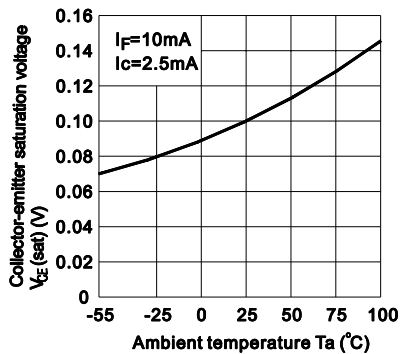

Fig.9 Collector Dark Current vs. Ambient Temperature

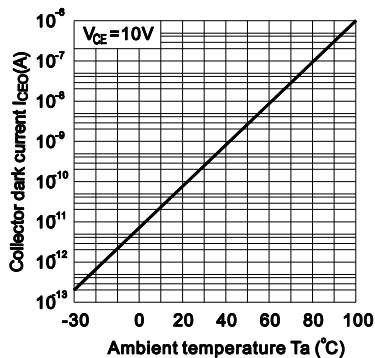

Fig.10 Response Time vs. Load Resistance

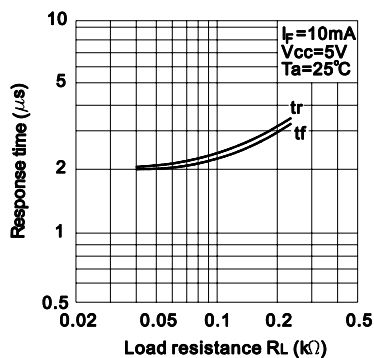
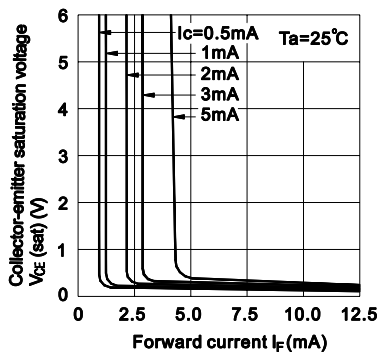
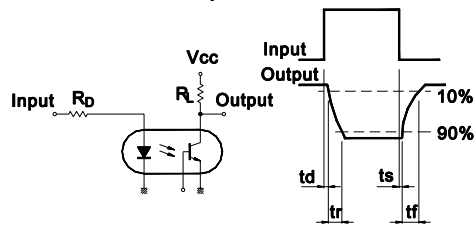

Fig.11 Collector-emitter Saturation Voltage vs. Forward Current



Test Circuit for Response Time



Test Circuit for Frequency Response

