

Silicon NPN Power Transistors

2SC4301

DESCRIPTION

- With TO-3PML package
- High voltage switching transistor

APPLICATIONS

- Switching Regulator,
- Lighting Inverter and general purpose

PINNING

PIN	DESCRIPTION
1	Base
2	Collector
3	Emitter

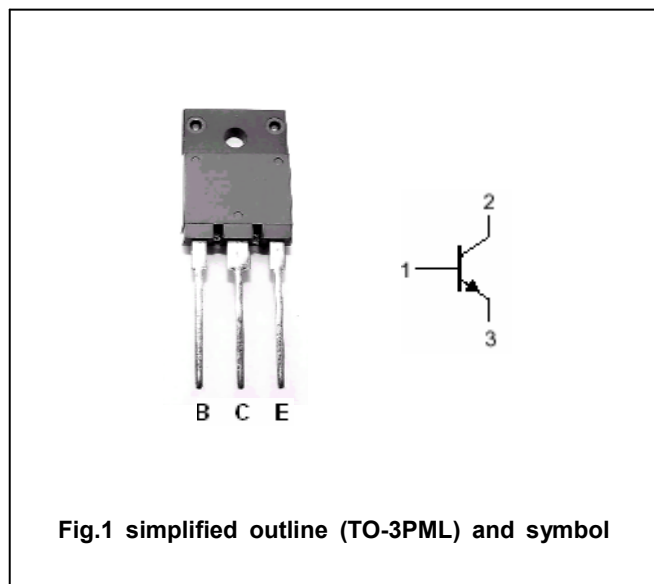
Absolute maximum ratings($T_a=25^\circ\text{C}$)

SYMBOL	PARAMETER	CONDITIONS	VALUE	UNIT
V_{CBO}	Collector-base voltage	Open emitter	900	V
V_{CEO}	Collector-emitter voltage	Open base	800	V
V_{EBO}	Emitter-base voltage	Open collector	7	V
I_C	Collector current		7	A
I_{CM}	Collector current-peak		14	A
I_B	Base current		3.5	A
P_C	Collector power dissipation	$T_C=25^\circ\text{C}$	80	W
T_j	Junction temperature		150	$^\circ\text{C}$
T_{stg}	Storage temperature		-55~150	$^\circ\text{C}$

Silicon NPN Power Transistors

2SC4301

CHARACTERISTICS

T_j=25°C unless otherwise specified

SYMBOL	PARAMETER	CONDITIONS	MIN	TYP.	MAX	UNIT
V _{(BR)CEO}	Collector-emitter breakdown voltage	I _C =10mA; I _B =0	800			V
V _{CEsat}	Collector-emitter saturation voltage	I _C =3A; I _B =0.6A			0.5	V
V _{BEsat}	Base-emitter saturation voltage	I _C =3A; I _B =0.6A			1.2	V
I _{CBO}	Collector cut-off current	V _{CB} =800V; I _E =0			100	μA
I _{EBO}	Emitter cut-off current	V _{EB} =7V; I _C =0			100	μA
h _{FE}	DC current gain	I _C =3A; V _{CE} =4V	10		30	
f _T	Transition frequency	I _E =-1A; V _{CE} =12V		6		MHz
C _{OB}	Output capacitance	V _{CB} =10V; f=1MHz		105		pF

Switching times

t _{on}	Turn-on time	I _C =3A; I _{B1} =0.45A; I _{B2} =-1.5A; R _L =83Ω; V _{CC} =250V			1	μs
t _{stg}	Storage time				5	μs
t _f	Fall time				1	μs

Silicon NPN Power Transistors

2SC4301

PACKAGE OUTLINE

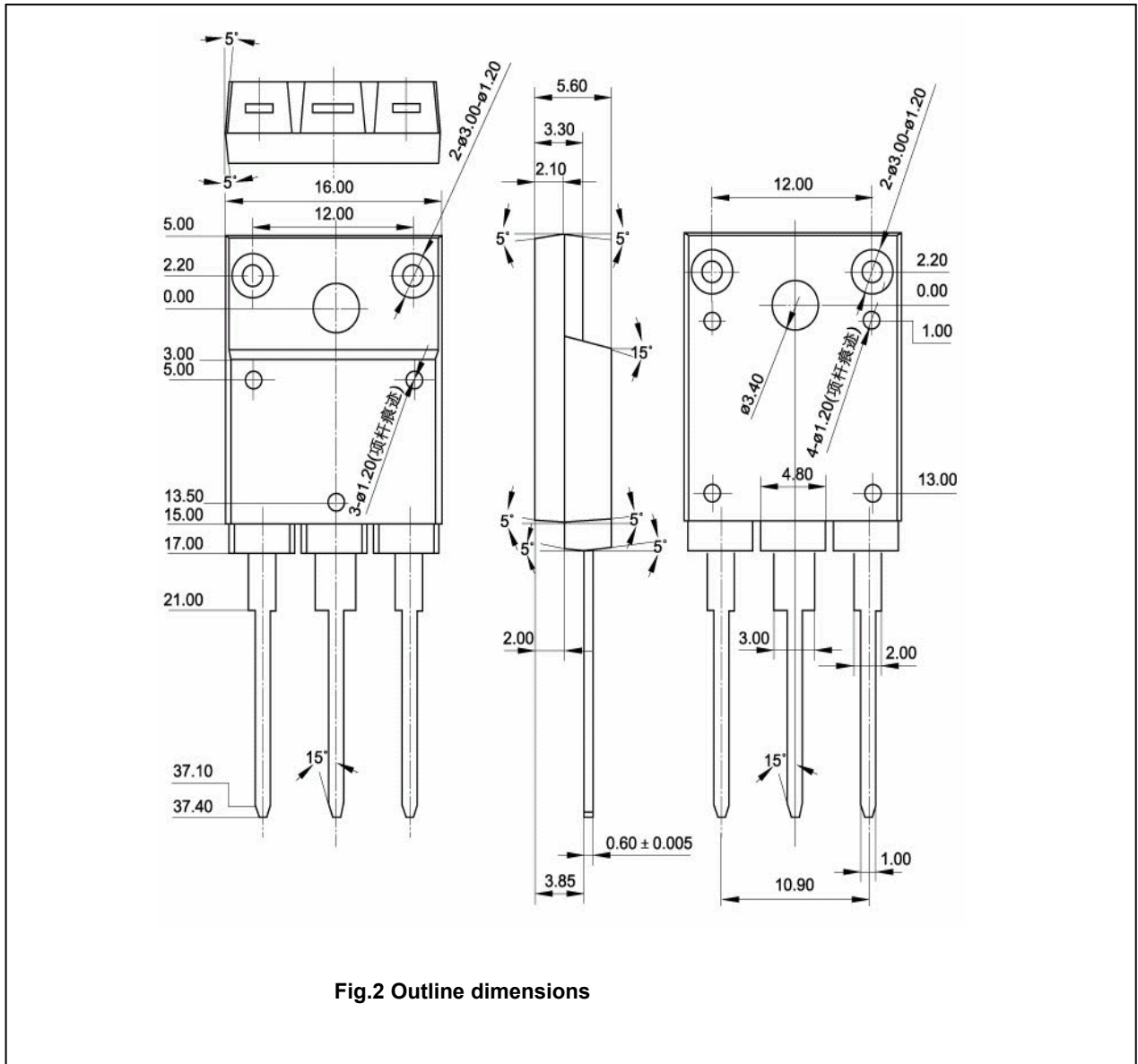

Fig.2 Outline dimensions

Silicon NPN Power Transistors

2SC4301

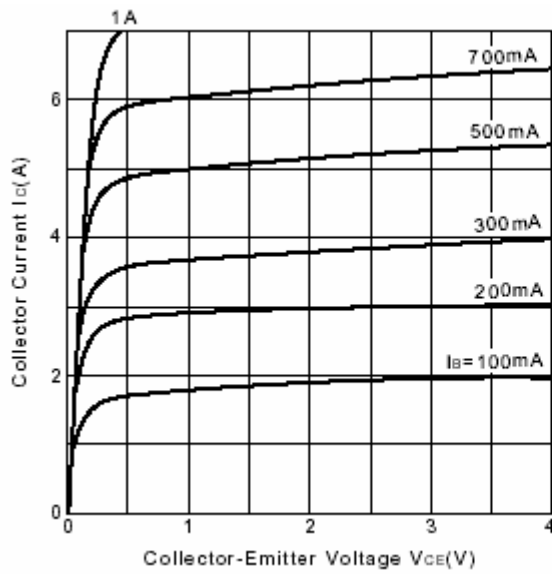

Fig.3 Static Characteristic

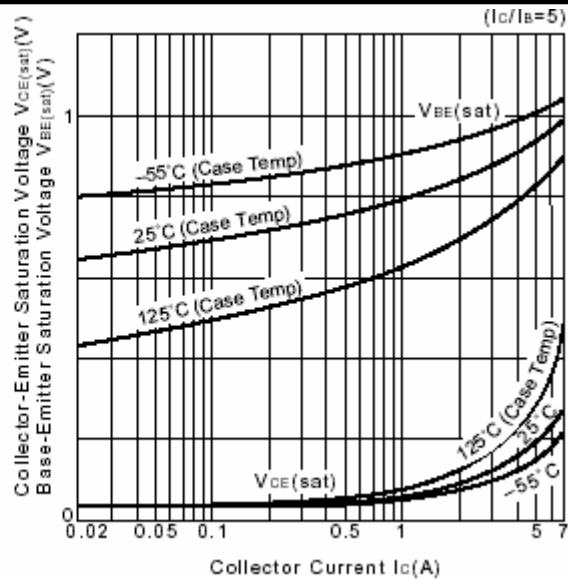

Fig.4 Base-Emitter Saturation Voltage
Collector-Emitter Saturation Voltage

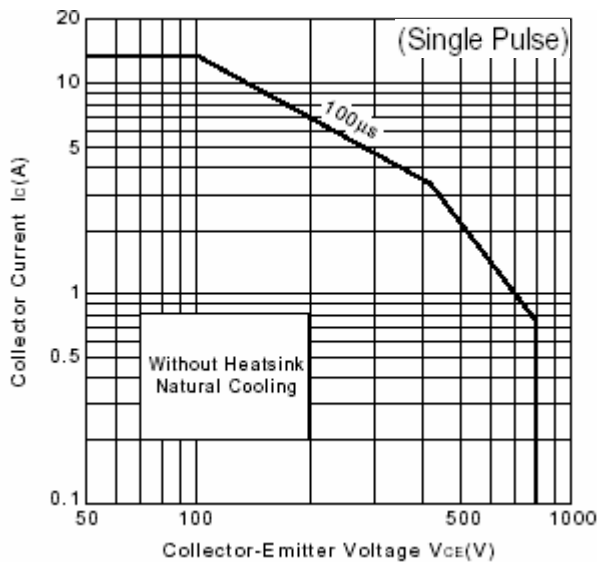

Fig.5 Safe Operating Area

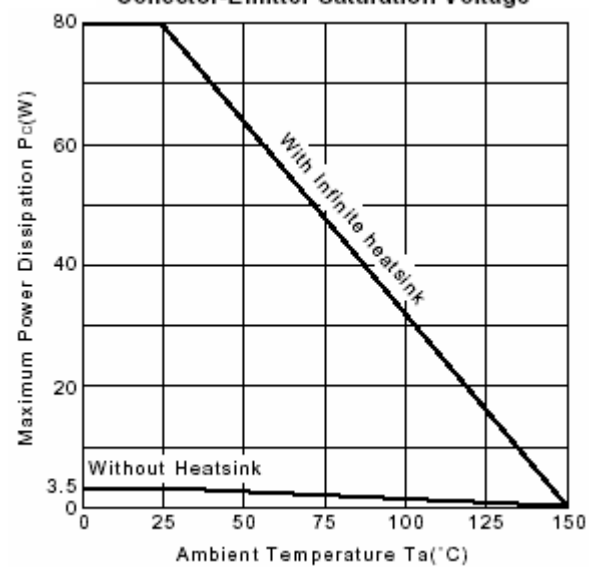

Fig.6 P_c - T_a Derating

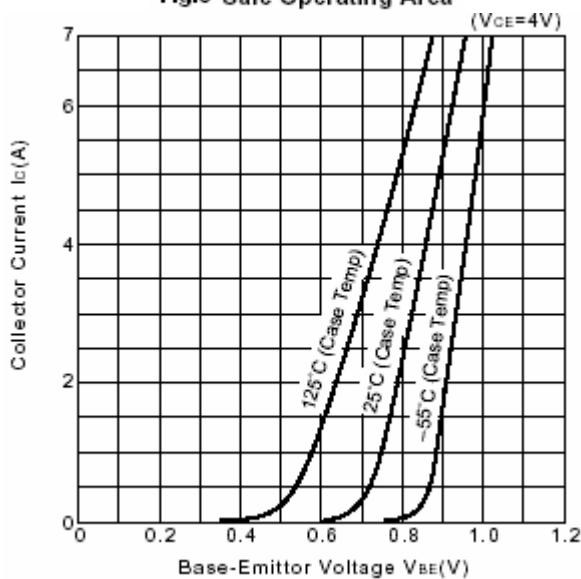

Fig.7 I_c - V_{BE}

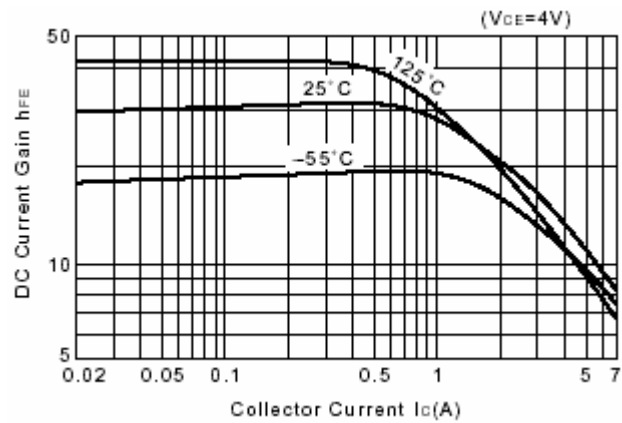

Fig.8 DC current Gain