

# Liquid Leakage Sensor Amplifier with Disconnection Detection Function K7L-AT50D/-AT50D-S

## Detect disconnections between the Sensor Amplifier and a Terminator connected to the end of the Sensing Band.

- Constantly monitors for disconnections between the Sensor Amplifier and the Sensing Band.
- Failure to detect liquid leakage due to disconnection in the Sensing Band prevented.
- Notification of disconnection detection made using LED indicator and transistor output.
- After a disconnection is detected, in order to avoid instability due to further contact of the disconnected part, the operating status is held.
- This model retains all the characteristics of the K7L-AT50 (detection sensitivity, sensing ranges, and AC detection method).
- Meets UL/CSA standards. (See information on standards on page 31.)

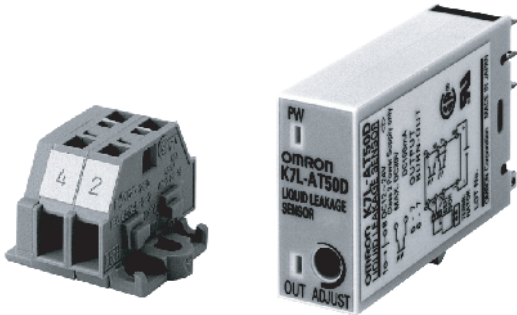

Level Controllers

## Application Examples

### Liquid Leakage Detection for Measuring Baths in CMP Devices

Detects liquid leaked to drain pans, and prevents damage to devices and cleaning irregularities for wafers.

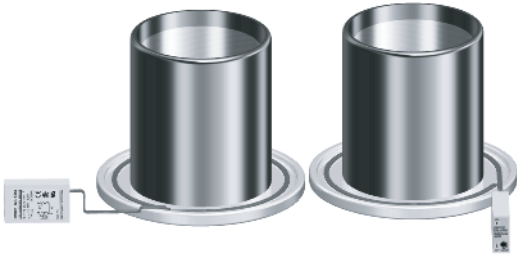

### Detection of Condensation and Liquid Leakage at Semiconductor Production Installations

Detects condensation inside cleaning devices and liquid leaked to the surroundings.

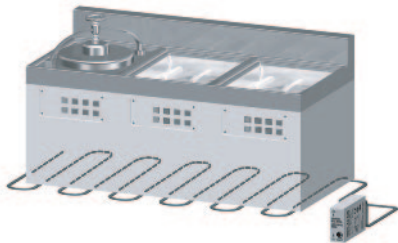

### Detection of Liquid Leakage at Pipe Joints for Chemical Liquid Tanks

Liquid leakage at a pipe joint can be detected by wrapping the Sensing Band around the joint.

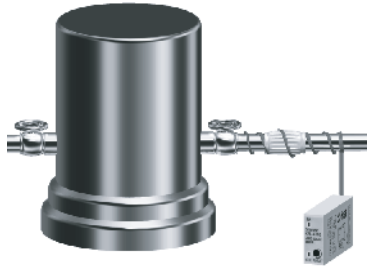

### Detection of Cleaning Fluid Level for Plating Devices

Detects the level of pure water inside plating baths. High sensitivity allows high-accuracy control that prevents cleaning irregularities.

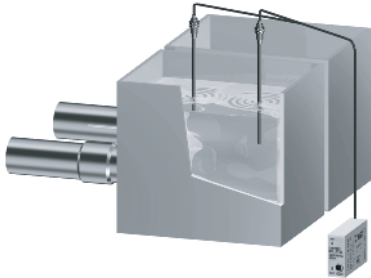

# Model Number Structure

---

## ■ Model Number Legend

K7L - AT50  -   
                   1      2

### 1. Disconnection Detection Function

Blank: No

D: Yes

### 2. S: Without terminator

## Ordering Information

---

### ■ List of Models

Name	Model number
Liquid Leakage Sensor Amplifier with Disconnection Detection Function Set	K7L-AT50D
Liquid Leakage Sensor Amplifier with Disconnection Detection Function Sensor Amplifier Only	K7L-AT50D-S
Terminator (2P)	F03-20T

**Note:** The Socket, Terminal Block, Sticker, and Sensing Band are the same as for the K7L-AT50.

# Specifications

## ■ Ratings

<b>Rated power supply voltage</b>	12 to 24 VDC (Allowable voltage fluctuation range: 10 to 30 VDC)
<b>Operate resistance</b>	0 Ω to 50 MΩ, variable Range 0: 0 to 250 kΩ Range 1: 0 to 600 kΩ Range 2: 0 to 5 MΩ Range 3: 0 to 50 MΩ  <b>Note:</b> The range used is set using the DIP switch on the side of the Sensor Amplifier. (Refer to <i>DIP Switch Settings</i> .) Set the corresponding pin of the DIP switch in the up position. (For range 0, set all 3 pins in the down position.) The adjuster (ADJUST) on the top of the Sensor Amplifier sets the resistance value for detection within the set range. It is factory-set to the upper limit. (Normally, use with the adjuster set to the upper limit.) With any range, resistance values can be set from 0 Ω.
<b>Disconnection detection function</b>	Detection signal: 10 VDC max., 200 ms Detection time: 10 s max. Release: Released by resetting the power supply.
<b>Release resistance</b>	105% min. of operate resistance
<b>Output configuration</b>	NPN open collector transistor output with 100 mA at 30 VDC max. for both liquid leakage detection and disconnection detection.  <b>Note:</b> If the rightmost pin of the DIP switch on the side of the Sensor Amplifier is set to the down position, the output turns ON when liquid/disconnection is detected; if it is set to the up position, the output turns OFF.
<b>Wiring distance</b>	Wiring cable: 50 m max. Sensing Band length: 10 m max.  <b>Note:</b> These values are possible on condition that a completely insulated 3-conductor VCT cable with a thickness of 0.75 mm <sup>2</sup> and a dielectric strength of 600 V is used together with a Liquid Sensing Band specified by OMRON. (A 0.2-mm <sup>2</sup> cable can also be used.)
<b>Accessories</b>	F03-20 Terminal Block (for connecting wiring cable and Sensing Band) Screwdriver for ADJUST setting. F03-20T Terminator (provided with K7L-AT50D only) (Purchase the Sensing Band, Sensing Band Sticker, wiring cable, and Socket separately. The Terminal Block is 3P; the Terminator is 2P.)

**Note:** UL File No. E138234  
CSA File No. LR95291-21

## ■ Characteristics

<b>Ambient temperature</b>	Operating: -10°C to 55°C
<b>Ambient humidity</b>	Operating: 45% to 85%
<b>Insulation resistance</b>	10 MΩ at 100 VDC between case and current-carrying parts
<b>Dielectric strength</b>	1,000 VAC at 50/60 Hz for 1 min between case and current-carrying parts
<b>Power consumption</b>	1 VA max.
<b>Response time</b>	Operate: 800 ms max. Release: 800 ms max.
<b>Weight</b>	Approx. 14 g

# Connections

## ■ Block Diagram for External Connections

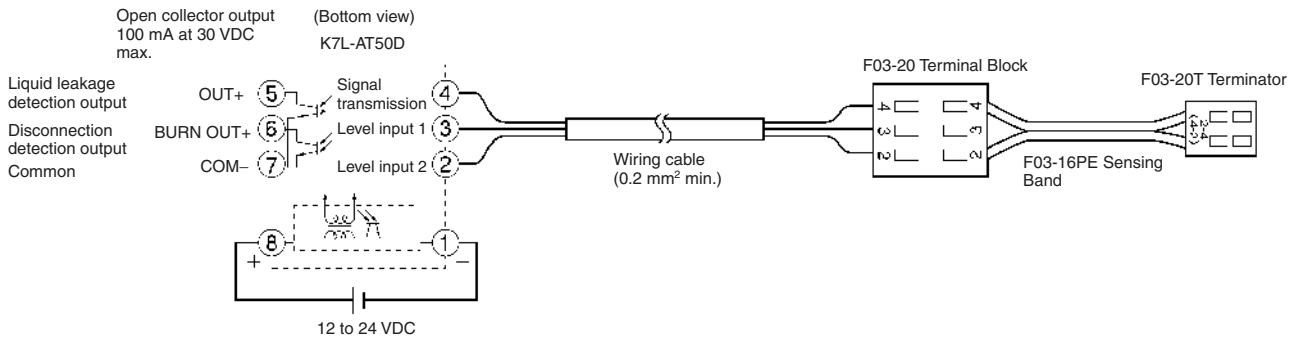

## Output Circuit

### ■ Connections Example

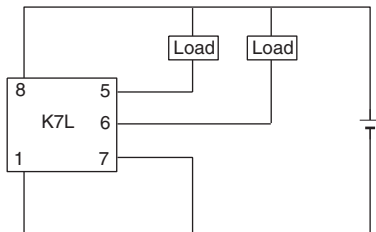

# Operation

## ■ Disconnection Detection Function

### Operation During Monitoring for Liquid Leakage

- Short-wave signals (2.5 VAC, 3.75 Hz) for liquid leakage detection are output from terminal 4 of the K7L.
- When there is no liquid leakage, the liquid leakage detection signals that are output are interrupted by the Terminator and the core of the Sensing Band will be an open loop.

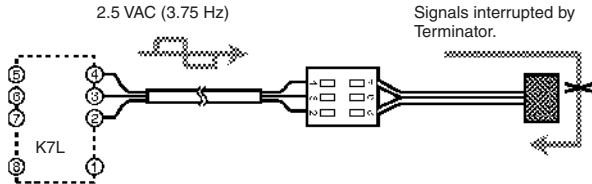

### Operation at Liquid Leakage Detection

- When liquid leakage occurs within the sensing range, the liquid leakage detection signals output from terminal 4 are input to terminal 2 through the leaked liquid.
- The voltage of the input signals will vary with the resistance of the leaked liquid. This voltage is compared with the detection level set at the K7L.
- As a result of the comparison, if the K7L determines that liquid leakage has occurred, the K7L's output LED will light, and the liquid detection output will either turn ON or OFF.

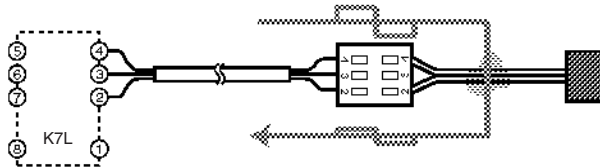

### Operation During Monitoring for Disconnection

- Output of disconnection detection signals starts within 2 s of power being supplied to the K7L and is repeated at 7-s intervals.
- Disconnection signals are DC signals of 10 V max. that are output for approximately 200 ms. During this time, the K7L is in disconnection monitoring mode, i.e. it monitors for disconnections only and the liquid leakage detection signals are stopped.
- If there is no disconnection, the disconnection detection signals (10 VDC) that are output pass through the Terminator and return to the K7L. The K7L takes this as normal, i.e., there is no disconnection.

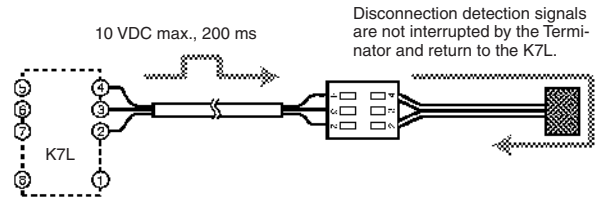

### Operation at Disconnection Detection

- If there is a disconnection, the signals will be interrupted at the place where the disconnection occurred, and will not return to the K7L.
- If the signals do not return, when the K7L is in disconnection monitoring mode it will determine that a disconnection has occurred. The output LED will flash, and the disconnection output will turn ON.

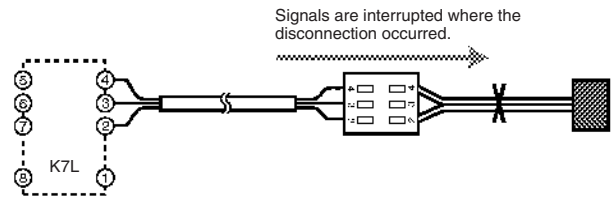

- Note:**
1. Disconnection detection is only performed between terminals 2 and 4. Therefore, be sure to connect the Sensing Band between terminals 2 and 4.
  2. The K7L will switch from liquid leakage detection to disconnection detection if either of the following conditions occur while liquid leakage is detected.
    - Disconnection occurs between the K7L and the place where liquid is leaked.
    - While liquid leakage is detected, disconnection occurs between the place where liquid is leaked and the Terminator (F03-20T) and, subsequently, the leaked liquid is removed (e.g., wiped up or dried).
  3. During disconnection detection, liquid leakage will not be detected. Once disconnection has been detected, reset the power supply to stop disconnection detection.

# Nomenclature

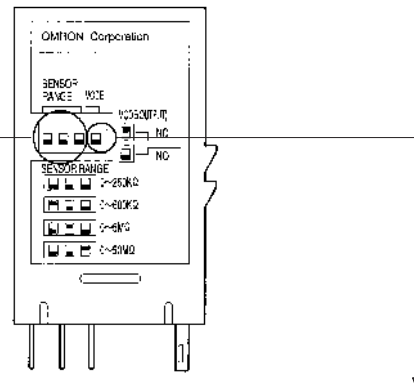
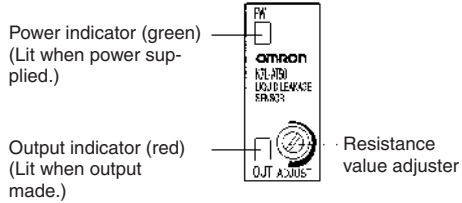

## ■ DIP Switch Settings Setting Detection Range

DIP switch	Range number	Detection range
	Range 0	0 to 250 kΩ
	Range 1	0 to 600 kΩ
	Range 2	0 to 5 MΩ
	Range 3	0 to 50 MΩ

DIP switch	Output
	Output OFF when liquid leakage detected.
	Output ON when liquid leakage detected.

- Set a detection range according to the impedance of the liquid to be detected. (If the detection range DIP switches are set in a way not shown above, the actual range used will be the largest one by default.) For the setting procedure refer to the label on the side of the Sensor Amplifier.
- It is possible to set the resistance value within the set detection range using the resistance value adjuster. At time of delivery, it is set to the largest possible value and for normal use this setting can be used.
- The resistance value adjuster is a precision component. Do not apply a torque to the resistance value adjuster in excess of the specified one. Doing so may cause the resistance value adjuster to be damaged.  
Applicable torque:
  - Rotational torque: 9.81 mN·m max.
  - Detent strength: 29.4 mN·m min.

# Dimensions

**Note:** All units are in millimeters unless otherwise indicated.

**K7L-AT50D**  
Liquid Leakage Sensor Amplifier

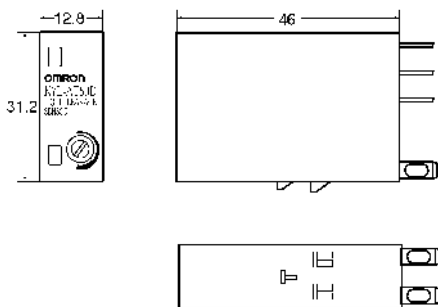

**F03-20T**  
Terminator

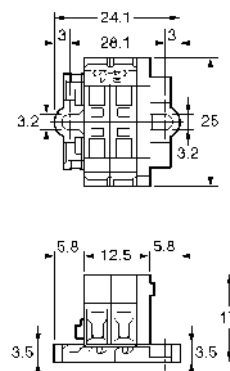

**Mounting Hole Dimensions**

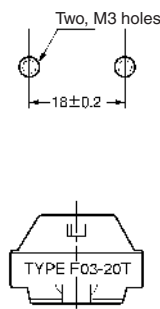

# Accessories (Order Separately)

## ■ Sensing Band F03-16PE

### Features

- Polyethylene used for sheath to ensure high resistance to chemicals.
- SUS316 used for core and polyethylene used for sheath to ensure high resistance to both acidic and alkaline liquids.
- Sensing Band Stickers that use the same material as the Sensing Band's insulating resin are available in 2 types: adhesive-tape type and screw type.



### Specifications

<b>Sheath</b>	Polyethylene
<b>Core</b>	Stainless steel SUS316
<b>Ambient operating temperature</b>	-15 to 55°C
<b>Applications</b>	<ul style="list-style-type: none"> <li>• Early detection of water leakage in computer rooms etc.</li> <li>• Used in locations with low-conductivity materials.</li> </ul>
<b>Weight</b>	Approx. 16 g (1 m)

Level Controllers

### Chemical Resistivity for the Sensing Band

Material	F03-16PE	
	Sheath	Core
	Polyethylene	SUS316
Water	A	A
Acetone	C	A
Ammonia	A	A
Ethanol	B	A
Hydrochloric acid	A	C
Hydrogen peroxide solution	A	A
Xylene	B	A
Cyclohexane	C	---
Trichloroethylene	C	A
Toluene	C	B
Phenol	B	A
Butanol	B	---
Fluorine	A	C
Hexane	C	---
Benzene	C	A
Methanol	B	A
Sulfuric acid	C	B
Phosphoric acid	A	B

- Note:**
1. A: Not affected at all or only very slightly affected.  
 B: Slightly affected but, depending on the conditions, sufficient for use.  
 C: Affected but may still be used. (Replace the Sensing Band immediately after detection.)
  2. In order to prevent secondary fire damage, consider the effect of the atmosphere of the environment and the solution to be detected on the Sensing Band.
  3. If the Sensing Band changes shape or color when a liquid is detected, replace the Sensing Band.

## Sensing Band

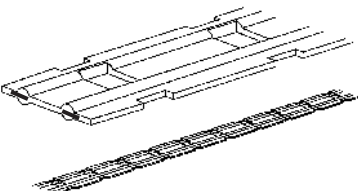
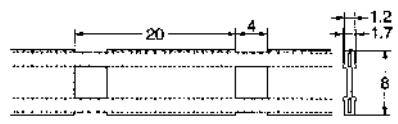
Model	Appearance	Structure	Material
F03-16PE			Sheath: Polyethylene Core: Stainless steel SUS316

**Note:** Specify length (in meter units) when ordering.  
When cleaning with a mop, for example, do not make contact with the Sensing Band.

## Sensing Band Sticker

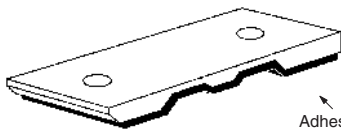
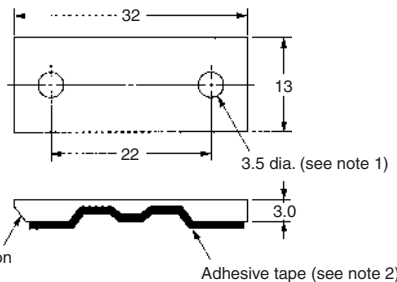
Model	Appearance	Structure
F03-26PE/ F03-26PEN for F03-16PE	<p>F03-26PE</p>  <p>Adhesive tape (see note)</p> <p><b>Note:</b> The adhesive part is on the F03-26PE only.</p>	 <p>Cut section</p> <p>Adhesive tape (see note 2)</p> <p>Material: Polyethylene</p> <p><b>Note:</b> 1. The holes are in the F03-26PEN only. 2. The adhesive part is on the F03-26PE only.</p>

## Connecting the Sensing Band

**Note:** Check that the wiring is secure before using the K7L in applications.

### Bending the Sensing Band

In order to change the direction of the Sensing Band, bend the Sensing Band in one or two places where the core is not exposed.

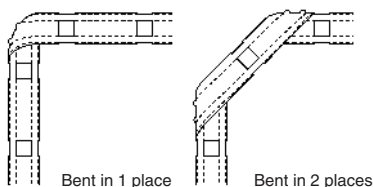

**Note:** Bend the Sensing Band approximately 4 cm (i.e., twice the distance between places where the core is exposed) away from places where the Sticker is attached. If the Sensing Band is bent at places further away than this, the Sensing Band may come away from the surface.

### Interval Between Stickers

When securing the Sensing Band with Stickers, attach the Stickers at intervals of 20 to 30 cm in places where the core is not exposed.

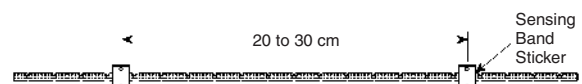

**Note:** 1. When using the F03-26PE (adhesive-tape model), be sure to wipe all moisture, oil, and dust from the surface to which the Sticker is to be attached. Failure to do so may result in insufficient adhesion, and the Sticker may peel away from the surface.  
2. When using the F03-26PEN (screw model), before installing the Sensing Band, it is necessary to perform stud welding. For details on the pitch of the studs, refer to the information on the dimensions of Sensing Band Stickers.

## Stripping and Connecting Terminals

1. Cut into the Sensing Band approximately 4 to 6 cm in from the end as shown in the diagram below.
2. Strip away approximately the last 9 mm of the sheath to expose the core (SUS line).
3. To connect to the Terminal Block, push down the top of the terminal with a screwdriver and insert the core from the side. (Refer to *Dimensions* on page 34.) More Sensing Bands can be connected simply by wiring in an arch shape.

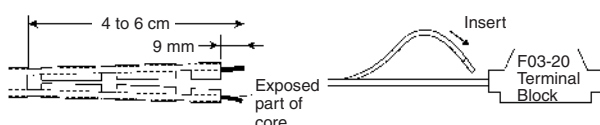



# Precautions

---

## ■ General Precautions

Before using the product under conditions which are not described in the manual or applying the product to nuclear control systems, railroad systems, aviation systems, vehicles, combustion systems, medical equipment, amusement machines, safety equipment, and other systems, machines, and equipment that may have a serious influence on lives and property if used improperly, consult your OMRON representative.

Make sure that the ratings and performance characteristics of the product are sufficient for the systems, machines, and equipment, and be sure to provide the systems, machines, and equipment with double safety mechanisms.

## ■ Safety Precautions

Observe the following points to ensure safe operation.

- Be sure to use a power supply voltage within the specified range. Not doing so may result in burning or malfunction.
- Do not use the product in locations subject to flammable gases or combustible objects. Not doing so may result in fire.
- Insert the connection points into Sockets until the connection is locked securely. Not doing so may result in burning or malfunction.
- Do not short-circuit loads connected to output terminals. Doing so may result in burning.
- Be sure to connect the power supply with the correct orientation. Not doing so may result in malfunction.

## ■ Correct Use

### Installation

Attach to a panel of thickness 1 to 5 mm.

Do not install in the following locations.

- Locations subject to shock or vibration.
- Locations where the temperature or humidity lies outside the specified range, or where condensation is likely to occur. (To detect liquids with high impedances, do not use in locations with high humidity.)
- Locations subject to dust.
- Locations subject to corrosive gases (particularly sulfide and ammonia gases).
- Outdoors or locations subject to direct sunlight.
- Near devices that generate strong high-frequency noise (e.g., high-frequency welding devices etc.).

# FAQs

Some questions that are frequently asked about the K7L are given below. Use this information when selecting a model.

## Can one K7L be used for detection in more than one place?

**Yes.**

By using Terminal Blocks to connect Sensing Bands in parallel, detection can be performed in more than place with only one K7L.

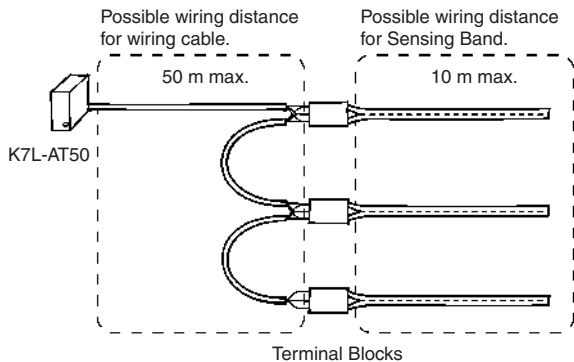

**Note:** When wiring, be sure not to exceed the maximum possible wiring distances for both the wiring cable and the Sensing Band. Exceeding these distances may lead to faulty operation. Connect one Sensing Band to the each Terminal Block.

## Can the K7L be used as a replacement for the 61F-GPN-V50 Water Leakage Detector?

**Yes.**

Because the surge withstand capability is different, however, do not use in locations where it will be exposed to impulses and surges such as outdoor roofs or pump panels. Also, items such as the power supply voltage and the connection sockets are different. Confirm these items before application.

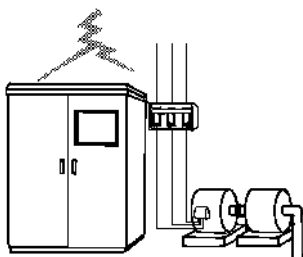

## Can a different terminal block (e.g. a commercially available terminal block or a terminal block constructed by the user) be used instead of the one provided?

**Yes.**

When using another terminal block, however, be sure to check that all the terminals are mutually isolated, and that there is no danger of ground faults in wiring cables or Sensing Bands.

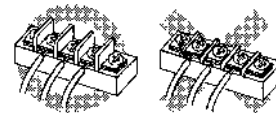

## Can the K7L detect pure water?

**Yes.**

Even pure water, which has a resistance exceeding 10 MΩ·cm, can nearly always be detected if the K7L is used at its maximum sensitivity. This is because impurities are mixed with the water when it is leaked and the resistance drops.

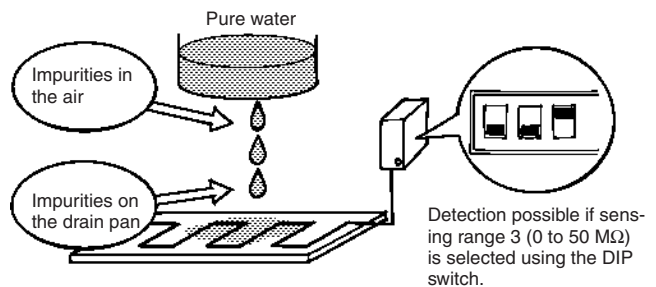

## Can the K7L detect oil?

**In most cases, no.**

If, however, it contains impurities such as metal powder, as is the case with cutting oil and used engine oil, detection may be possible (actual instances of detection have been observed). The user should confirm whether the required kind of detection is possible before application.

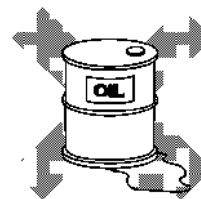

ALL DIMENSIONS SHOWN ARE IN MILLIMETERS.  
To convert millimeters into inches, multiply by 0.03937. To convert grams into ounces, multiply by 0.03527.