

# PM75B5L1C060

FLAT-BASE TYPE  
INSULATED PACKAGE

PM75B5L1C060



**FEATURE**

- a) Adopting new 5th generation Full-Gate CSTBT™ chip
  - b) Error output signal is possible from all each protection upper and lower IGBT
  - c) The mounting surface is 90mm×50mm about 30% less than B5LA type
- Monolithic gate drive & protection logic
  - Detection, protection & status indication circuits for, short-circuit, over-temperature & under-voltage

**APPLICATION**

Photo voltaic power conditioner

**PACKAGE OUTLINES**

Dimensions in mm

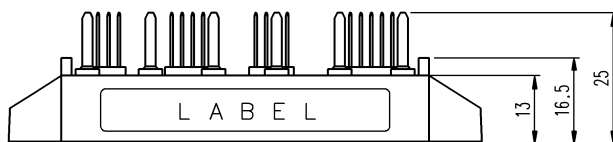
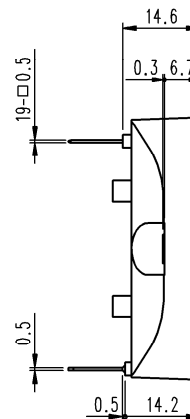
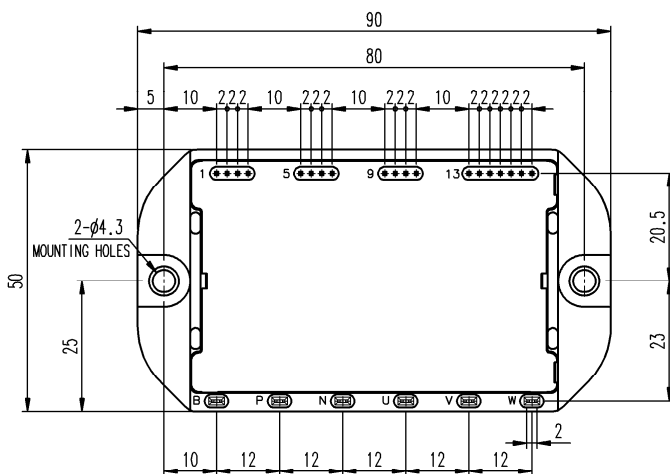

**Terminal code**

1. VUPC	8. VVP1	15. NC
2. UFo	9. NC	16. UN
3. UP	10. NC	17. VN
4. VUP1	11. NC	18. WN
5. VVPC	12. NC	19. Fo
6. VFo	13. VNC	
7. VP	14. VN1	

# PM75B5L1C060

FLAT-BASE TYPE  
INSULATED PACKAGE

## INTERNAL FUNCTIONS BLOCK DIAGRAM

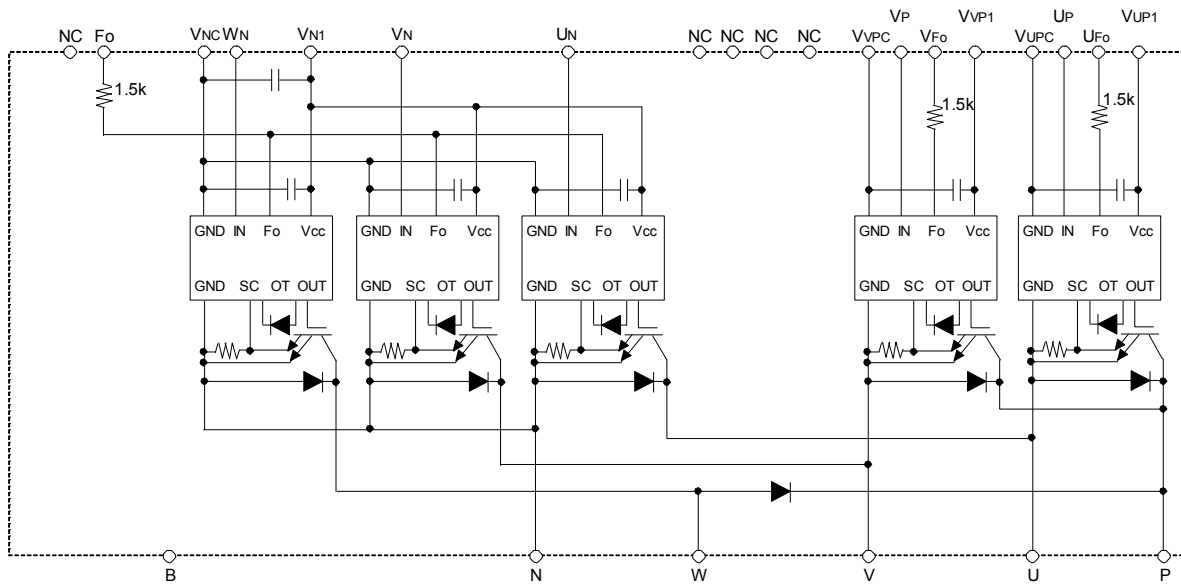

### MAXIMUM RATINGS ( $T_j = 25^\circ\text{C}$ , unless otherwise noted)

#### INVERTER PART

Symbol	Parameter	Conditions	Ratings	Unit
$V_{CES}$	Collector-Emitter Voltage	$V_D=15\text{V}$ , $V_{CIN}=15\text{V}$	600	V
$I_C$	Collector Current	$T_C=25^\circ\text{C}$	75	A
$I_{CRM}$		Pulse	150	
$P_{tot}$	Total Power Dissipation	$T_C=25^\circ\text{C}$	201	W
$I_E$	Emitter Current	$T_C=25^\circ\text{C}$	75	A
$I_{ERM}$	(Free wheeling Diode Forward current)	Pulse	150	
$T_j$	Junction Temperature		-20 ~ +150	$^\circ\text{C}$

\*:  $T_c$  measurement point is just under the chip.

#### CONVERTER PART

Symbol	Parameter	Conditions	Ratings	Unit
$V_{CES}$	Collector-Emitter Voltage	$V_D=15\text{V}$ , $V_{CIN}=15\text{V}$	600	V
$I_C$	Collector Current	$T_C=25^\circ\text{C}$	75	A
$I_{CRM}$		Pulse	150	
$P_{tot}$	Total Power Dissipation	$T_C=25^\circ\text{C}$	201	W
$I_E$	Emitter Current	$T_C=25^\circ\text{C}$	75	A
$I_{ERM}$	(Free wheeling Diode Forward current)	Pulse	150	
$I_F$	Di Forward Current	$T_C=25^\circ\text{C}$	75	A
$V_{R(DC)}$	Di Rated DC Reverse Voltage	$T_C=25^\circ\text{C}$	600	V
$T_j$	Junction Temperature		-20 ~ +150	$^\circ\text{C}$

\*:  $T_c$  measurement point is just under the chip.

# PM75B5L1C060

FLAT-BASE TYPE  
INSULATED PACKAGE

## CONTROL PART

Symbol	Parameter	Conditions	Ratings	Unit
$V_D$	Supply Voltage	Applied between : $V_{UP1}-V_{UPC}, V_{VP1}-V_{VPC}, V_{N1}-V_{NC}$	20	V
$V_{CIN}$	Input Voltage	Applied between : $UP-V_{UPC}, VP-V_{VPC}, UN \cdot VN \cdot WN -V_{NC}$	20	V
$V_{FO}$	Fault Output Supply Voltage	Applied between : $UFo-V_{UPC}, VFo-V_{VPC}, Fo-V_{NC}$	20	V
$I_{FO}$	Fault Output Current	Sink current at $UFo, VFo, Fo$ terminals	20	mA

## TOTAL SYSTEM

Symbol	Parameter	Conditions	Ratings	Unit
$V_{CC(PROT)}$	Supply Voltage Protected by SC	$V_D = 13.5V \sim 16.5V$ Inverter Part, $T_j = +125^\circ C$ Start	450	V
$V_{CC(surge)}$	Supply Voltage (Surge)	Applied between : P-N, Surge value	500	V
$T_{stg}$	Storage Temperature		-40 ~ +125	$^\circ C$
$V_{isol}$	Isolation Voltage	60Hz, Sinusoidal, RMS, Charged part to Base, AC 1min.	2500	V

\*:  $T_C$  measurement point is just under the chip.

## THERMAL RESISTANCE

Symbol	Parameter	Conditions	Limits			Unit
			Min.	Typ.	Max.	
$R_{th(i-c)Q}$	Thermal Resistance	Inverter, IGBT (per 1 element) (Note.1)	-	-	0.62	K/W
$R_{th(i-c)D}$		Inverter, FWDi (per 1 element) (Note.1)	-	-	1.06	
$R_{th(i-c)Q}$		Converter, IGBT (per 1 element) (Note.1)	-	-	0.62	
$R_{th(i-c)D}$		Converter, FWDi (per 1 element) (Note.1)	-	-	1.06	
$R_{th(i-c)D}$		Converter, Di (per 1 element) (Note.1)	-	-	1.06	
$R_{th(c-s)}$	Contact Thermal Resistance	Case to heat sink, (per 1 module) Thermal grease applied (Note.1)	-	0.06	-	

Note.1: If you use this value,  $R_{th(s-a)}$  should be measured just under the chips.

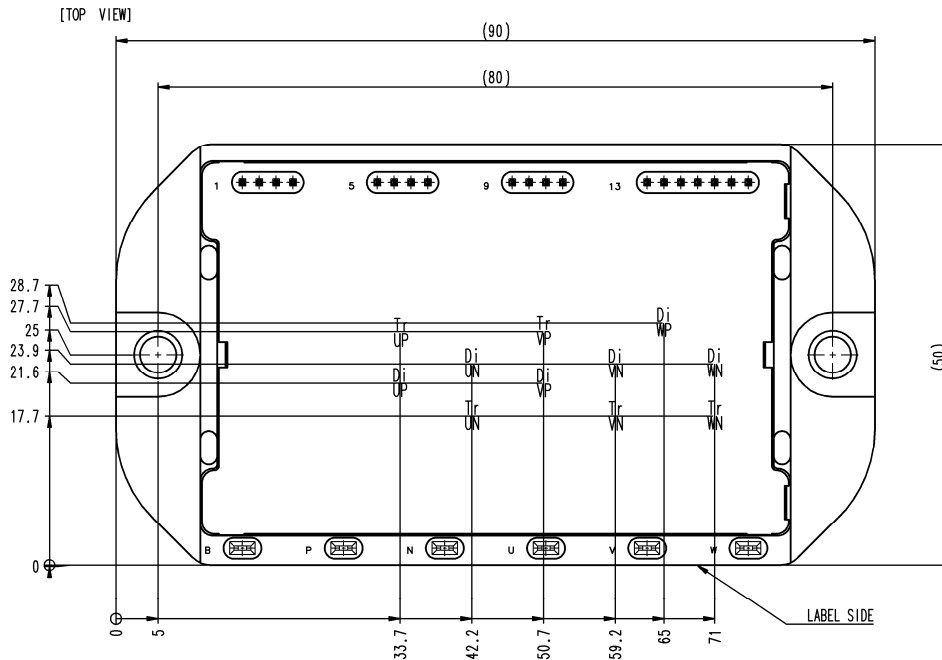

ELECTRICAL CHARACTERISTICS (T<sub>j</sub> = 25°C, unless otherwise noted)

## INVERTER PART

Symbol	Parameter	Conditions	Limits			Unit	
			Min.	Typ.	Max.		
V <sub>CEsat</sub>	Collector-Emitter Saturation Voltage	V <sub>D</sub> =15V, I <sub>C</sub> =75A V <sub>CIN</sub> =0V, Pulsed (Fig. 1)	T <sub>j</sub> =25°C	-	2.2	2.7	V
			T <sub>j</sub> =125°C	-	2.2	2.7	
V <sub>EC</sub>	Emitter-Collector Voltage	I <sub>E</sub> =75A, V <sub>D</sub> =15V, V <sub>CIN</sub> =15V (Fig. 2)	-	2.4	3.3	V	
t <sub>on</sub>	Switching Time	V <sub>D</sub> =15V, V <sub>CIN</sub> =0V↔15V V <sub>CC</sub> =300V, I <sub>C</sub> =75A T <sub>j</sub> =125°C Inductive Load (Fig. 3,4)	-	0.1	0.5	1.2	μs
t <sub>rr</sub>			-	-	0.1	0.2	
t <sub>c(on)</sub>			-	-	0.15	0.3	
t <sub>off</sub>			-	-	1.1	2.0	
t <sub>c(off)</sub>			-	-	0.2	0.4	
I <sub>CES</sub>	Collector-Emitter Cut-off Current	V <sub>CE</sub> =V <sub>CES</sub> , V <sub>D</sub> =15V, V <sub>CIN</sub> =15V (Fig. 5)	T <sub>j</sub> =25°C	-	-	1	mA
			T <sub>j</sub> =125°C	-	-	10	

## CONVERTER PART

Symbol	Parameter	Conditions	Limits			Unit	
			Min.	Typ.	Max.		
V <sub>CEsat</sub>	Collector-Emitter Saturation Voltage	V <sub>D</sub> =15V, I <sub>C</sub> =75A V <sub>CIN</sub> =0V, Pulsed (Fig. 1)	T <sub>j</sub> =25°C	-	2.2	2.7	V
			T <sub>j</sub> =125°C	-	2.2	2.7	
V <sub>EC</sub>	Emitter-Collector Voltage	I <sub>E</sub> =75A, V <sub>D</sub> =15V, V <sub>CIN</sub> =15V (Fig. 2)	-	2.4	3.3	V	
V <sub>FM</sub>	Di Forward Voltage	I <sub>F</sub> =75A	-	2.4	3.3	V	
t <sub>on</sub>	Switching Time	V <sub>D</sub> =15V, V <sub>CIN</sub> =0V↔15V V <sub>CC</sub> =300V, I <sub>C</sub> =75A T <sub>j</sub> =125°C Inductive Load (Fig. 3,4)	-	0.1	0.5	1.2	μs
t <sub>rr</sub>			-	-	0.1	0.2	
t <sub>c(on)</sub>			-	-	0.15	0.3	
t <sub>off</sub>			-	-	1.1	2.0	
t <sub>c(off)</sub>			-	-	0.2	0.4	
I <sub>CES</sub>	Collector-Emitter Cut-off Current	V <sub>CE</sub> =V <sub>CES</sub> , V <sub>D</sub> =15V, V <sub>CIN</sub> =15V (Fig. 5)	T <sub>j</sub> =25°C	-	-	1	mA
			T <sub>j</sub> =125°C	-	-	10	

## CONTROL PART

Symbol	Parameter	Conditions	Limits			Unit	
			Min.	Typ.	Max.		
I <sub>D</sub>	Circuit Current	V <sub>D</sub> =15V, V <sub>CIN</sub> =15V	V <sub>N1</sub> -V <sub>NC</sub>	-	6.5	12	mA
			V <sub>P1</sub> -V <sub>PC</sub>	-	1.6	4.0	
V <sub>th(ON)</sub>	Input ON Threshold Voltage	Applied between : UP-V <sub>UPC</sub> , VP-V <sub>VPC</sub> , UN·VN·WN -V <sub>NC</sub>	-	1.2	1.5	1.8	V
V <sub>th(OFF)</sub>	Input OFF Threshold Voltage		-	1.7	2.0	2.3	
SC	Short Circuit Trip Level	-20≤T <sub>j</sub> ≤125°C, V <sub>D</sub> =15V (Fig. 3, 6)	112	-	-	A	
t <sub>off(SC)</sub>	Short Circuit Current Delay Time	V <sub>D</sub> =15V (Fig. 3, 6)	-	0.2	-	μs	
OT	Over Temperature Protection	Detect Temperature of IGBT chip	Trip level	135	-	-	°C
OT <sub>(hys)</sub>			Hysteresis	-	20	-	
UV <sub>t</sub>	Supply Circuit Under-Voltage Protection	-20≤T <sub>j</sub> ≤125°C	Trip level	11.5	12.0	12.5	V
UV <sub>r</sub>			Reset level	-	12.5	-	
I <sub>FO(H)</sub>	Fault Output Current	V <sub>D</sub> =15V, V <sub>FO</sub> =15V (Note.2)	-	-	0.01	mA	
I <sub>FO(L)</sub>			-	10	15		
t <sub>FO</sub>	Fault Output Pulse Width	V <sub>D</sub> =15V (Note.2)	1.0	1.8	-	ms	

Note.2: Fault output is given only when the internal SC, OT & UV protections schemes of either upper or lower arm device operate to protect it.

**PM75B5L1C060**

**FLAT-BASE TYPE  
INSULATED PACKAGE**

**MECHANICAL RATINGS AND CHARACTERISTICS**

Symbol	Parameter	Conditions	Limits			Unit
			Min.	Typ.	Max.	
$M_t$	Mounting Torque	Mounting part screw : M4	1.4	1.65	1.9	N·m
m	Weight	-	-	135	-	g

**RECOMMENDED CONDITIONS FOR USE**

Symbol	Parameter	Conditions	Recommended value	Unit
$V_{CC}$	Supply Voltage	Applied across P-N terminals	$\leq 450$	V
$V_D$	Control Supply Voltage	Applied between : $V_{UP1}-V_{UPC}$ , $V_{VP1}-V_{VPC}$ ; $V_{N1}-V_{NC}$ (Note.3)	$15.0 \pm 1.5$	V
$V_{CIN(ON)}$	Input ON Voltage	Applied between : $UP-V_{UPC}$ , $VP-V_{VPC}$ , $UN \cdot VN \cdot WN -V_{NC}$	$\leq 0.8$	V
$V_{CIN(OFF)}$	Input OFF Voltage		$\geq 9.0$	
$f_{PWM}$	PWM Input Frequency	Using Application Circuit of Fig. 8	$\leq 20$	kHz
$t_{dead}$	Arm Shoot-through Blocking Time	For IPM's each input signals (Fig. 7)	$\geq 2.0$	$\mu s$
$I_o$	Module Operating Current	RMS	$\leq 30$	A

Note.3: With ripple satisfying the following conditions:  $dv/dt$  swing  $\leq \pm 5V/\mu s$ , Variation  $\leq 2V$  peak to peak

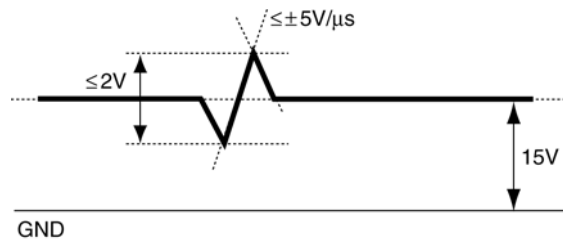

# PM75B5L1C060

FLAT-BASE TYPE  
INSULATED PACKAGE

## PRECAUTIONS FOR TESTING

1. Before applying any control supply voltage ( $V_D$ ), the input terminals should be pulled up by resistors, etc. to their corresponding supply voltage and each input signal should be kept off state.  
After this, the specified ON and OFF level setting for each input signal should be done.
2. When performing "SC" tests, the turn-off surge voltage spike at the corresponding protection operation should not be allowed to rise above  $V_{CES}$  rating of the device.  
(These test should not be done by using a curve tracer or its equivalent.)

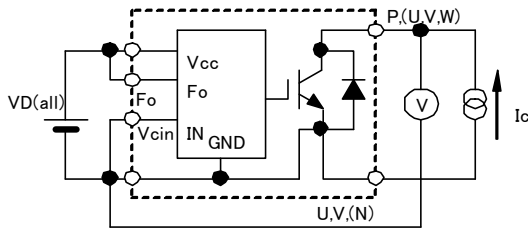

Fig. 1  $V_{CESat}$  Test

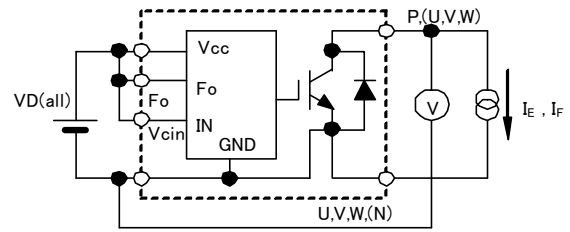

Fig. 2  $V_{EC}$ ,  $V_{FM}$  Test

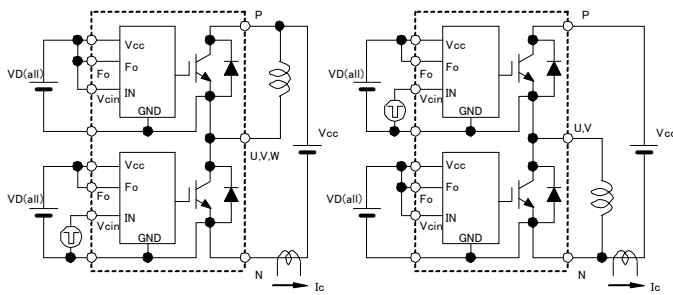

Fig. 3 Switching time and SC test circuit

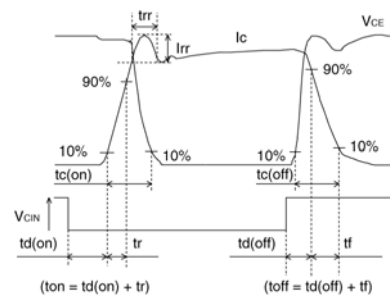

Fig. 4 Switching time test waveform

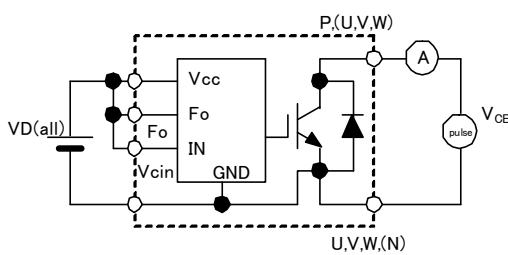

Fig. 5  $I_{CES}$  Test

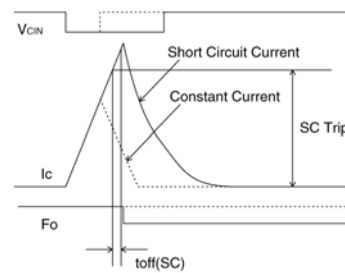
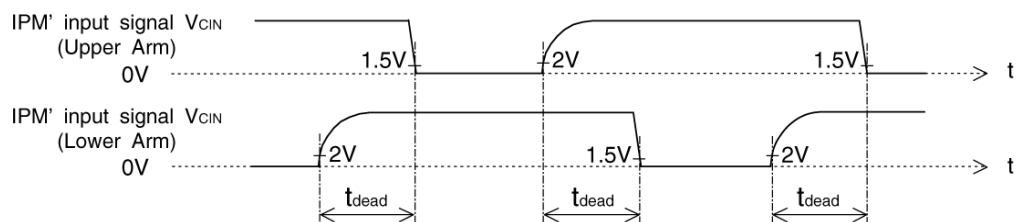

Fig. 6 SC test waveform



1.5V: Input on threshold voltage  $V_{th(on)}$  typical value, 2V: Input off threshold voltage  $V_{th(off)}$  typical value

Fig. 7 Dead time measurement point example

PM75B5L1C060

FLAT-BASE TYPE  
INSULATED PACKAGE

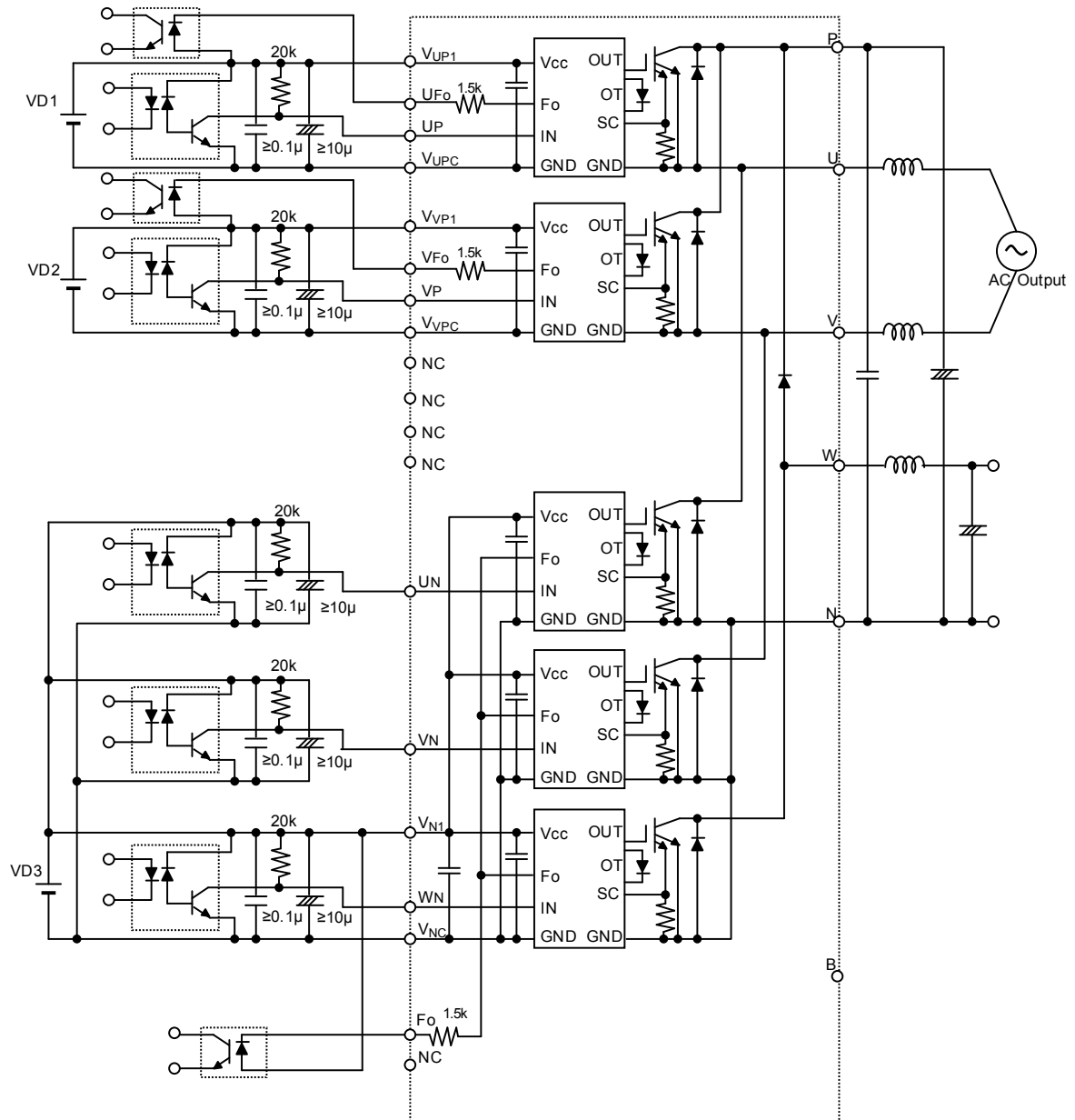

Fig. 8 Application Example Circuit

**NOTES FOR STABLE AND SAFE OPERATION ;**

- Design the PCB pattern to minimize wiring length between opto-coupler and IPM's input terminal, and also to minimize the stray capacity between the input and output wirings of opto-coupler.
- Connect low impedance capacitor between the Vcc and GND terminal of each fast switching opto-coupler.
- Fast switching opto-couplers:  $t_{PLH}, t_{PHL} \leq 0.8\mu s$ , Use High CMR type.
- Slow switching opto-coupler: CTR > 100%
- Use 3 isolated control power supplies ( $V_D$ ). Also, care should be taken to minimize the instantaneous voltage charge of the power supply.
- Make inductance of DC bus line as small as possible, and minimize surge voltage using snubber capacitor between P and N terminal.

**PERFORMANCE CURVES**

**OUTPUT CHARACTERISTICS**

(TYPICAL)

**INVERTER PART & CONVERTER PART**

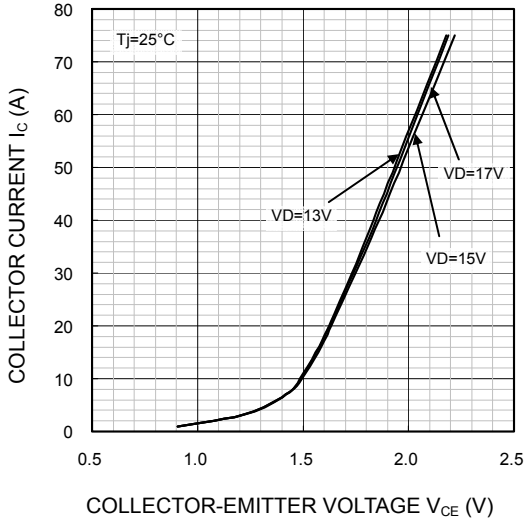

**COLLECTOR-EMITTER SATURATION VOLTAGE (VS.  $I_c$ ) CHARACTERISTICS**

(TYPICAL)

**INVERTER PART & CONVERTER PART**

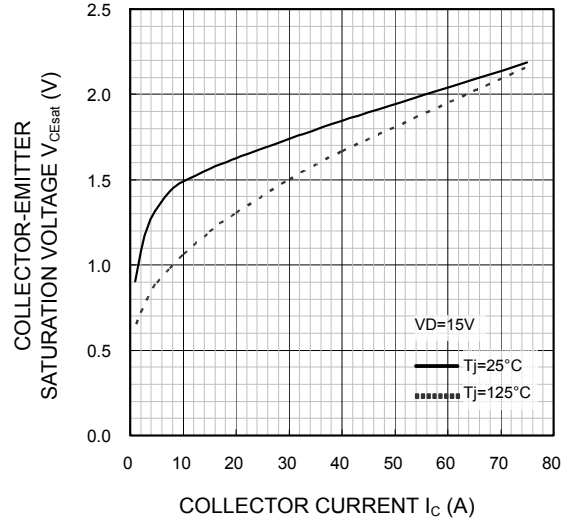

**COLLECTOR-EMITTER SATURATION VOLTAGE (VS.  $V_D$ ) CHARACTERISTICS**

(TYPICAL)

**INVERTER PART & CONVERTER PART**

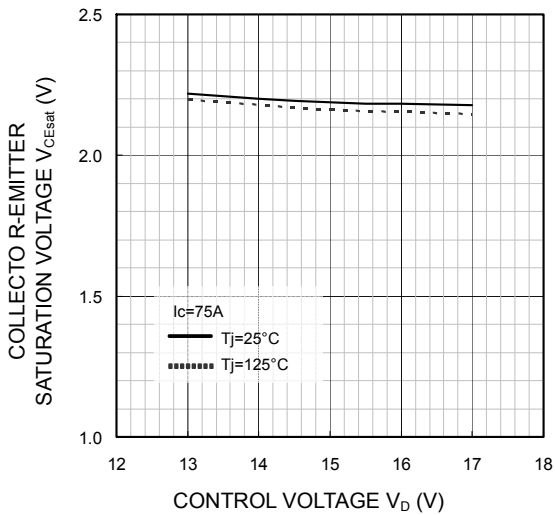

**FREE WHEELING DIODE & DIODE FORWARD CHARACTERISTICS**

(TYPICAL)

**INVERTER PART & CONVERTER PART**

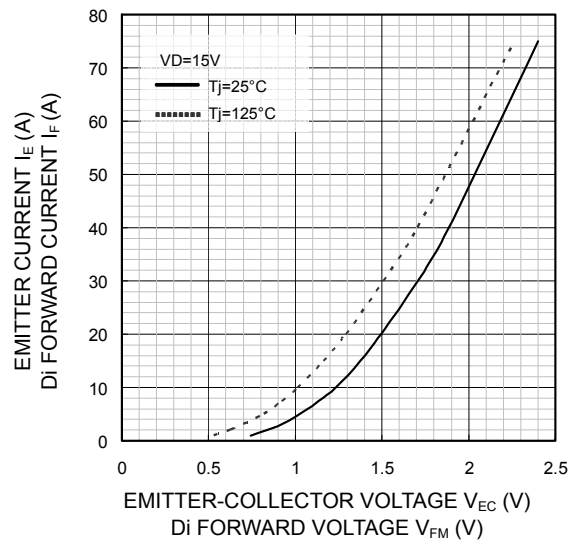



PM75B5L1C060

FLAT-BASE TYPE  
INSULATED PACKAGE

SWITCHING TIME ( $t_{on}$ ,  $t_{off}$ ) CHARACTERISTICS  
(TYPICAL)

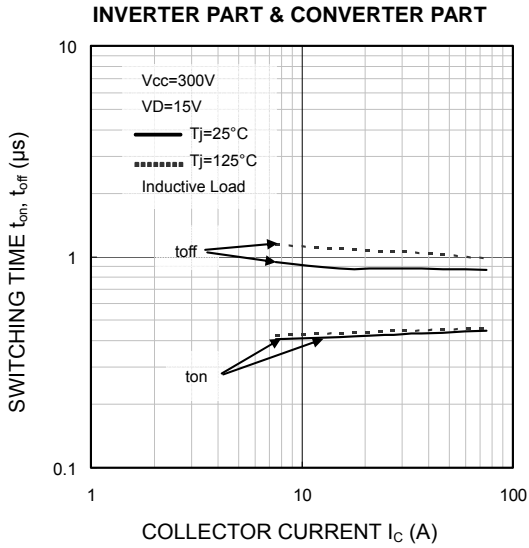

SWITCHING TIME ( $t_{c(on)}$ ,  $t_{c(off)}$ ) CHARACTERISTICS  
(TYPICAL)

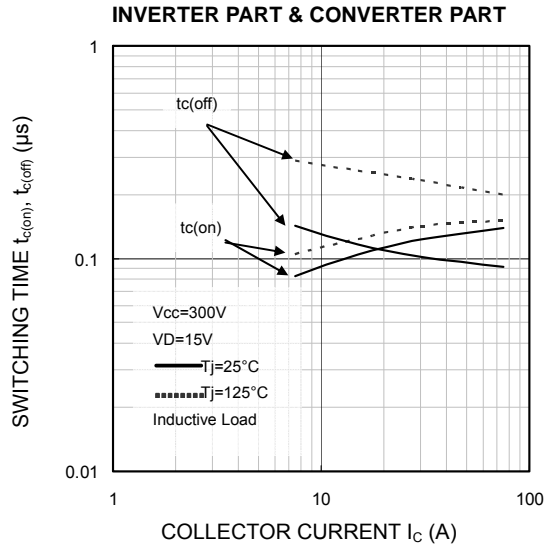

SWITCHING ENERGY CHARACTERISTICS  
(TYPICAL)  
INVERTER PART

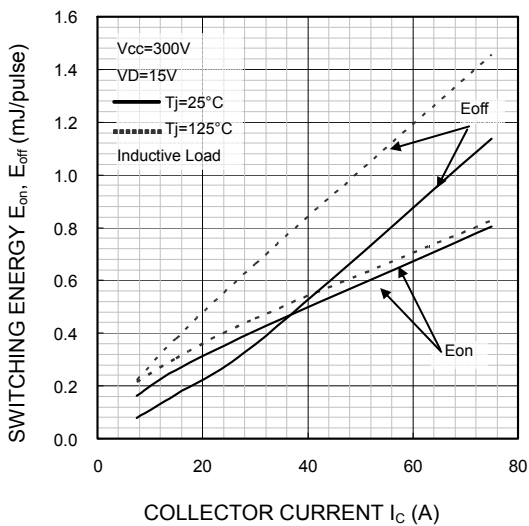

SWITCHING ENERGY CHARACTERISTICS  
(TYPICAL)  
CONVERTER PART

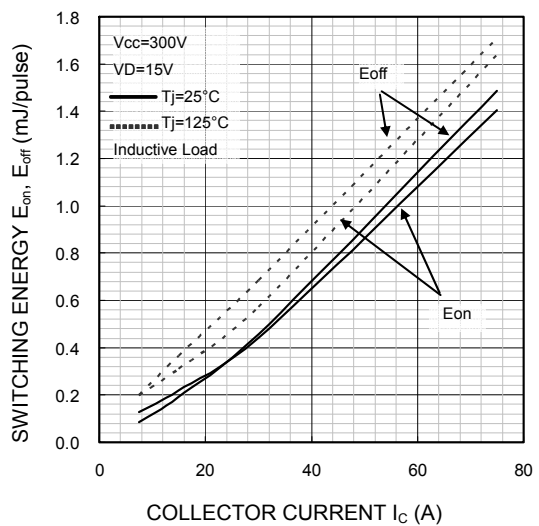

PM75B5L1C060

FLAT-BASE TYPE  
INSULATED PACKAGE

FREE WHEELING DIODE  
REVERSE RECOVERY CHARACTERISTICS  
(TYPICAL)  
INVERTER PART

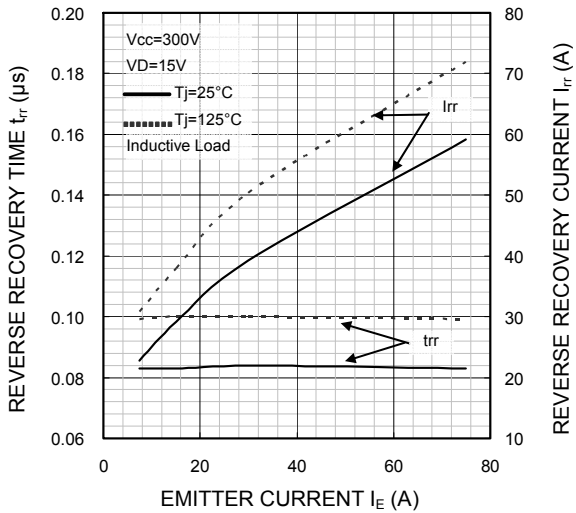

FREE WHEELING DIODE  
REVERSE RECOVERY CHARACTERISTICS  
(TYPICAL)  
CONVERTER PART

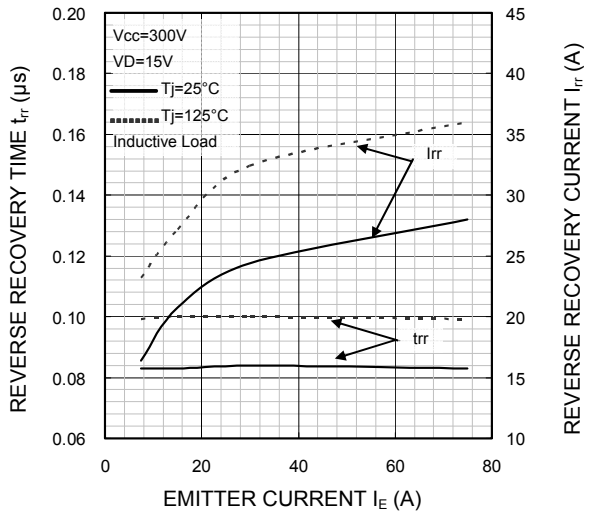

FREE WHEELING DIODE  
REVERSE RECOVERY ENERGY  
CHARACTERISTICS  
(TYPICAL)  
INVERTER PART

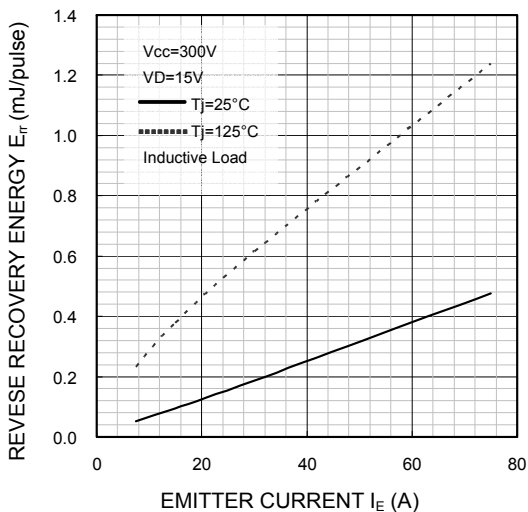

FREE WHEELING DIODE  
REVERSE RECOVERY ENERGY  
CHARACTERISTICS  
(TYPICAL)  
CONVERTER PART

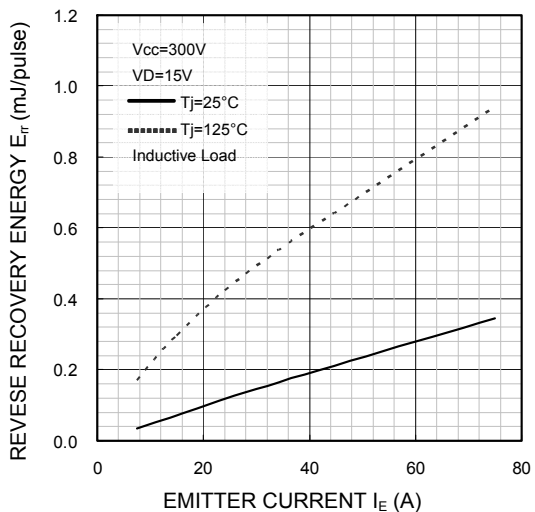

**PM75B5L1C060**

FLAT-BASE TYPE  
INSULATED PACKAGE

**I<sub>D</sub> VS. f<sub>c</sub> CHARACTERISTICS  
(TYPICAL)**

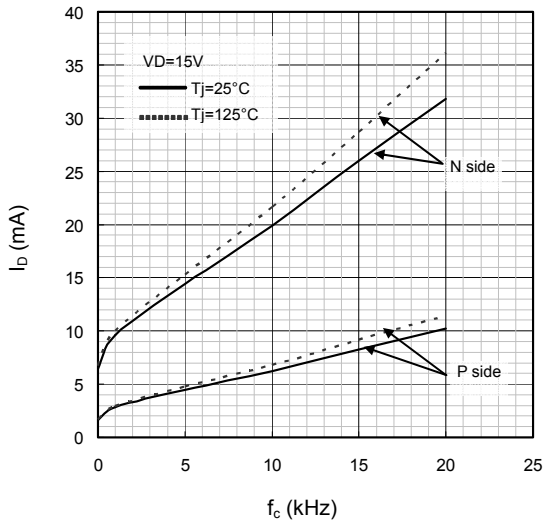

**UV TRIP LEVEL VS. T<sub>j</sub> CHARACTERISTICS  
(TYPICAL)**

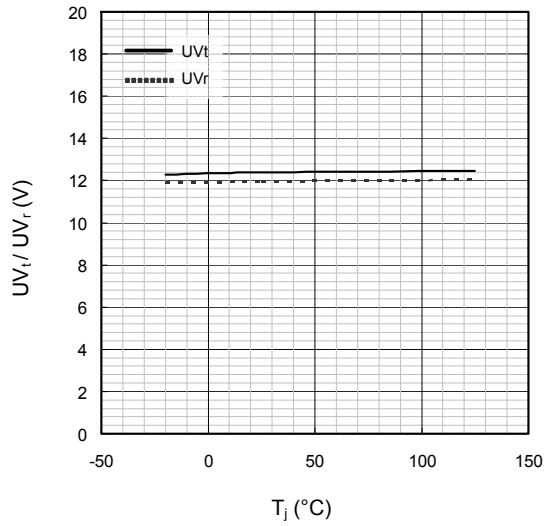

**SC TRIP LEVEL VS. T<sub>j</sub> CHARACTERISTICS  
(TYPICAL)  
INVERTER PART & CONVERTER PART**

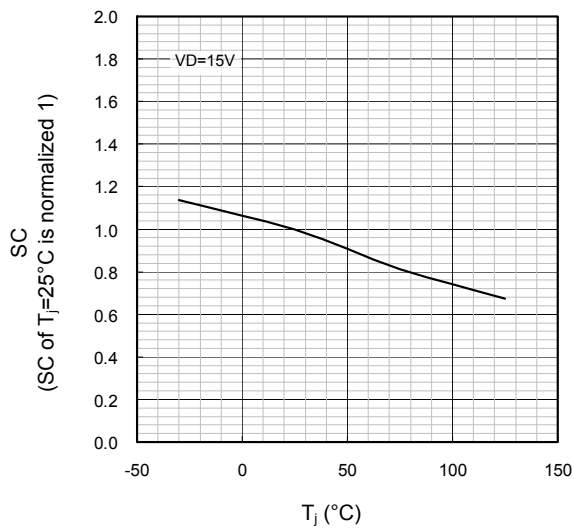

**PM75B5L1C060**

**FLAT-BASE TYPE  
INSULATED PACKAGE**

**TRANSIENT THERMAL  
IMPEDANCE CHARACTERISTICS  
INVERTER PART**

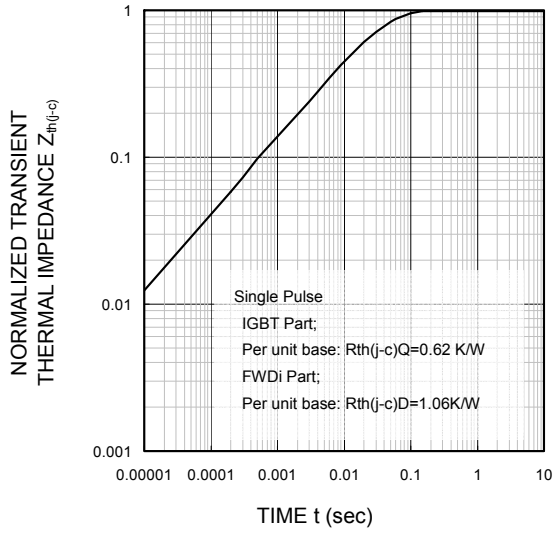

**TRANSIENT THERMAL  
IMPEDANCE CHARACTERISTICS  
CONVERTER PART**

