

Slide Switches

Standard Slide Switches

SB5 Series

Slide Switches

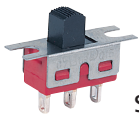

SPDT

SB5S1A1A1T1__

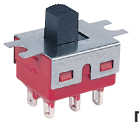
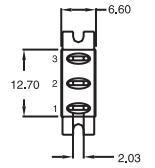
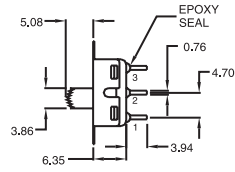
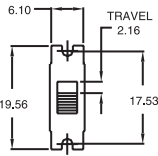

DPDT

SB5D1A1A1T1__

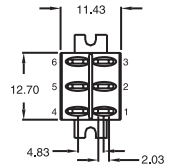
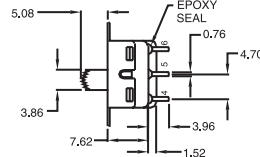
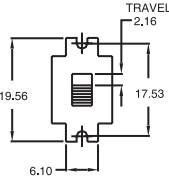

SPDT

SB5S1A1A0T6__

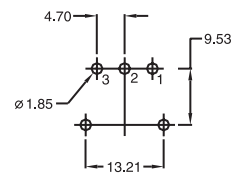
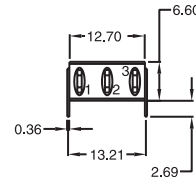
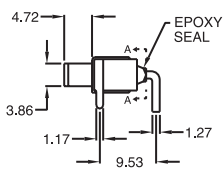
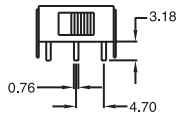

DPDT

SB5D1A1A0T6__

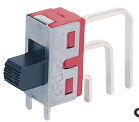
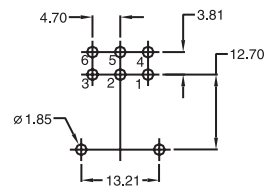
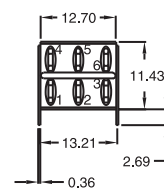
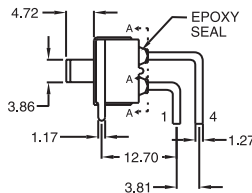
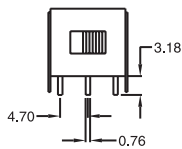

SPDT

SB5S1A1A0T7__

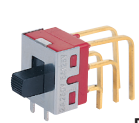
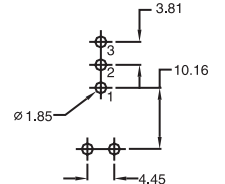
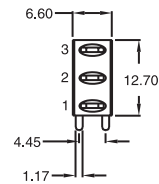
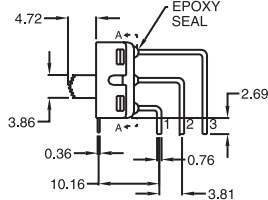
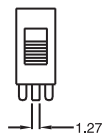

DPDT

SB5D1A1A0T7__

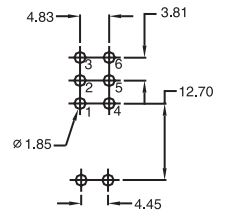
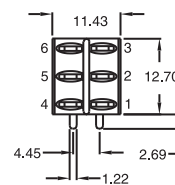
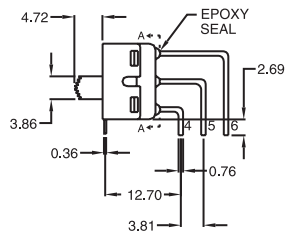
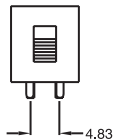

How to order:

SB5

- 1 POLES & SWITCHING:**
 S1 SP ON-NONE-ON
 S2 SP ON-NONE-MOM
 S3 SP ON-OFF-ON
 D1 DP ON-NONE-ON
 D2 DP ON-OFF-ON

- E** Yellow
F Green
G Blue
H Gray
K Brown

- 4 MOUNTING EARS:**
 0 No Mounting ears
 1 With Mounting Ears

- 5 TERMINALS:**
 T1 Solder Lug
 T2 PC Thru-Hole
 T3 Quick Connect
 T51 18.70 mm high Wire Wrap
 T52 24.20 mm high Wire Wrap
 T53 10.50 mm high Wire Wrap
 T54 26.97 mm high Wire Wrap
 T6 Right Angle PC Thru-Hole
 T7 Vertical Right Angle
 VS2 PC Thru-Hole
 V-Bracket

- 6 CONTACT MATERIAL:**
 AG Silver
 AU Gold
 UT Gold, tin-lead
 GT Silver, tin-lead
 UG Gold over Silver
 UGT Gold over Silver, tin-lead

- 7 SEAL:**
 E Epoxy (Standard)
 N No Epoxy

- 8 ROHS & LEAD FREE:**
 blank RoHS Compliant (Standard)
 V RoHS Compliant & Lead Free

- 3 ACTUATOR COLOR:**
 A Black (Standard)
 B White
 C Red
 D Orange

General Specifications:

MATERIALS

- » Movable Contact:
 AG, GT, UG & UGT: Silver plated over copper alloy
 AU & UT: Gold over nickel plated over copper alloy
- » Fixed Terminal:
 AG, GT, UG & UGT: Silver plated over copper alloy
 AU & UT: Gold over nickel plated over copper alloy

MECHANICAL

- » Operating Temperature: -30°C to +85°C
- » Mechanical Life: 30,000 cycles

CONTACT RATING

- » AG, GT, UG & UGT: 5A120VAC/28VDC
 2A250VAC
- » AU & UT: 0.4VA max. 20V max. (AC/DC)

ELECTRICAL

- » Contact Resistance: 10mΩ max. initial @ 2-4VDC
 100mA for silver & gold plated contacts
- » Insulation Resistance: 1,000MΩ min.

Slide Switches

Standard Slide Switches

SB5 Series

Slide Switches

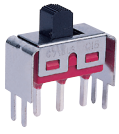

SPDT

SB5S1A1A0VS2_ _

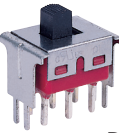
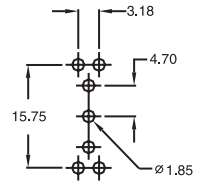
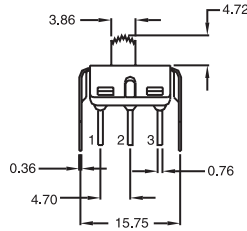
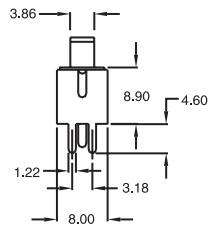

DPDT

SB5D1A1A0VS2_ _

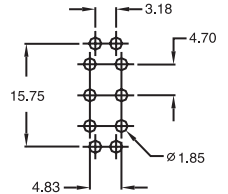
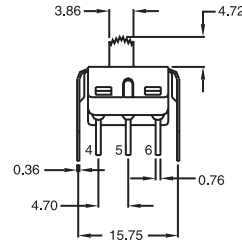
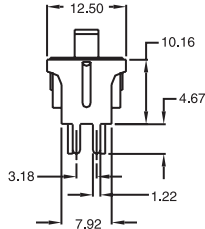

ACTUATOR OPTIONS

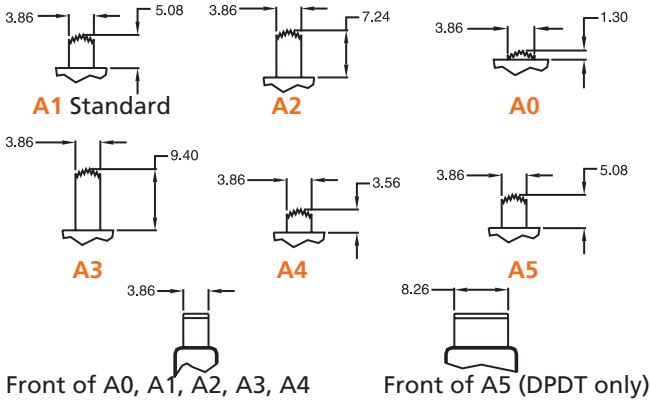

MOUNTING EARS

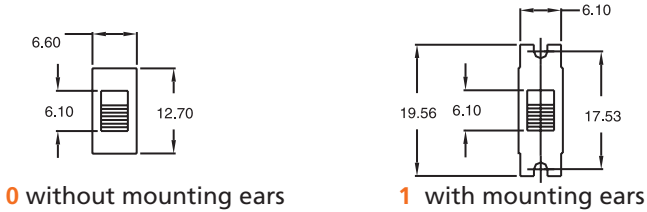

MOUNTING EARS (3 POSITIONS ONLY)

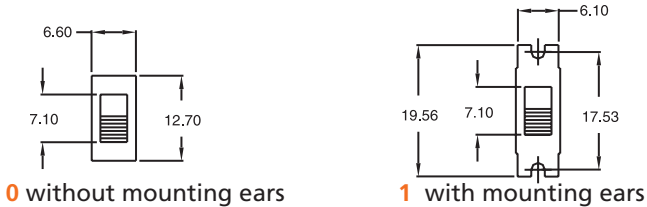

TERMINAL OPTIONS

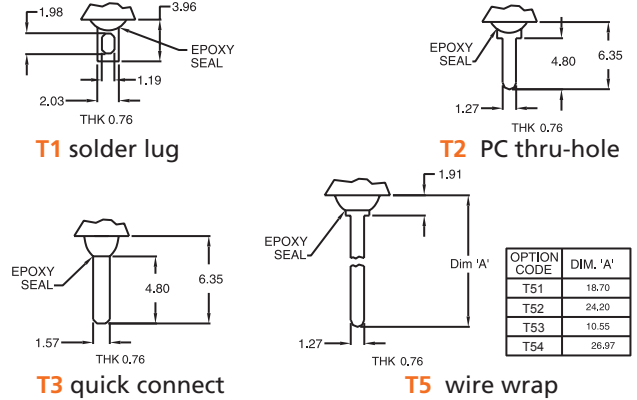

PANEL MOUNTING

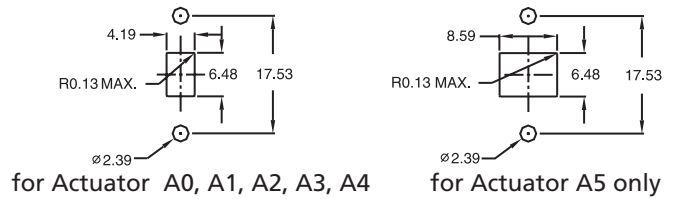

PANEL MOUNTING (3 POSITIONS ONLY)

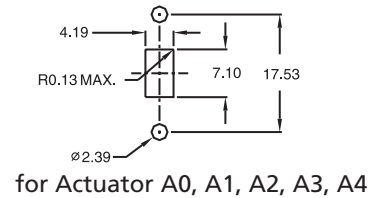

SWITCH FUNCTION

NO. POLES	MODEL NO.	SWITCH FUNCTION			CONNECTED TERMINALS / SCHEMATIC		
		POS.1	POS.2	POS.3	POS.1	POS.2	POS.3
SP	SB5S1	ON	NONE	ON	2-1 2(COMM) 1 3	OPEN	2-3 2(COMM) 1 3
	SB5S2	ON	NONE	MOM			
	SB5S3	ON	OFF	ON			
DP	SB5D1	ON	NONE	ON	2-1,5-4 2(COMM) 5 1 3 4 6	OPEN	2-3,5-6 2(COMM) 5 1 3 4 6
	SB5D2	ON	OFF	ON			

MOM=MOMENTARY