

NEC's MEDIUM POWER NPN SILICON HIGH FREQUENCY TRANSISTOR

NE677M04

FEATURES

- **HIGH GAIN BANDWIDTH:**
f_T = 15 GHz
- **HIGH OUTPUT POWER:**
P_{-1dB} = 15 dBm at 1.8 GHz
- **HIGH LINEAR GAIN:**
G_L = 15.5 dB at 1.8 GHz
- **NEW LOW PROFILE M04 PACKAGE:**
SOT-343 footprint, with a height of only 0.59 mm
Flat lead style for better RF performance

DESCRIPTION

NEC's NE677M04 is fabricated using NEC's HFT3 wafer process. With a transition frequency of 15 GHz, the NE677M04 is usable in applications from 100 MHz to 3 GHz. The NE677M04 provides P_{1dB} of 15 dBm, even with low voltage and low current, making this device an excellent choice for the driver stage for mobile or fixed wireless applications.

NEC's NE677M04 is housed in NEC's new low profile/flat lead style "M04" package

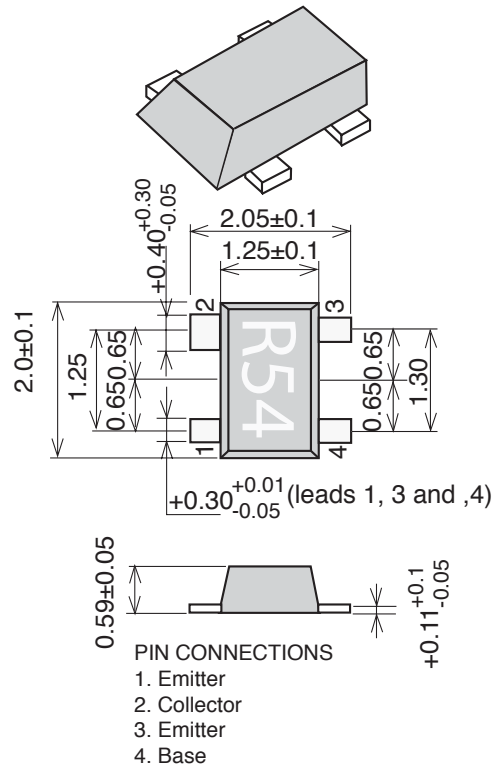

ELECTRICAL CHARACTERISTICS (T_A = 25°C)

PART NUMBER PACKAGE OUTLINE EIAJ ³ REGISTRATION NUMBER		NE677M04 M04 2SC5751				
SYMBOLS	PARAMETERS AND CONDITIONS	UNITS	MIN	TYP	MAX	
DC	I _{CBO}	Collector Cutoff Current at V _{CB} = 5V, I _E = 0	nA		100	
	I _{EBO}	Emitter Cutoff Current at V _{EB} = 1 V, I _C = 0	nA		100	
	h _{FE}	DC Current ¹ Gain at V _{CE} = 3 V, I _C = 20 mA		75	120	150
RF	P _{1dB}	Output Power at 1 dB compression point at V _{CE} = 2.8 V, I _{CQ} = 8 mA, f = 1.8 GHz, P _{in} = 1 dBm	dBm		15.0	
	G _L	Linear Gain at V _{CE} = 2.8 V, I _{CQ} = 8 mA, f = 1.8 GHz, P _{in} = -10 dBm	dB		15.5	
	MAG	Maximum Available Gain ⁴ at V _{CE} = 3 V, I _C = 20 mA, f = 2 GHz	dBm		16.0	
	S ₂₁ / S ₁₂ ²	Insertion Power Gain at V _{CE} = 3 V, I _C = 20 mA, f = 2 GHz	dB	10.0	13.5	
	η _c	Collector Efficiency at V _{CE} = 2.8 V, I _{CQ} = 8 mA, f = 1.8 GHz, P _{in} = 1 dBm	%		50	
	NF	Noise Figure at V _{CE} = 3 V, I _C = 5 mA, f = 2 GHz, Z _s = Z _{OPT}	dB		1.7	2.5
	f _T	Gain Bandwidth at V _{CE} = 3 V, I _C = 20 mA, f = 2 GHz	GHz		15	
C _{re}	Reverse Transfer Capacitance ² at V _{CB} = 3 V, I _C = 0, f = 1 MHz	pF		0.22	0.50	

Notes:

1. Pulsed measurement, pulse width ≤ 350 μs, duty cycle ≤ 2 %.
2. Collector to Base capacitance measured by capacitance meter (automatic balance bridge method) when emitter pin is connected to the guard pin of capacitance meter.
3. Electronic Industriail Association of Japan
4. $MAG = \frac{|S_{21}|}{|S_{12}|} (K \pm \sqrt{K^2 - 1})$.

NE677M04

ABSOLUTE MAXIMUM RATINGS¹ (T_A = 25°C)

SYMBOLS	PARAMETERS	UNITS	RATINGS
V _{CB0}	Collector to Base Voltage	V	9.0
V _{CEO}	Collector to Emitter Voltage	V	6.0
V _{EB0}	Emitter to Base Voltage	V	2.0
I _c	Collector Current	mA	50
P _T	Total Power Dissipation ²	mW	205
T _J	Junction Temperature	°C	150
T _{STG}	Storage Temperature	°C	-65 to +150

Note:

- Operation in excess of any one of these parameters may result in permanent damage.
- Mounted on a 1.08cm² x 1.0 mm thick glass epoxy PCB.

ORDERING INFORMATION

PART NUMBER	QUANTITY
NE677M04-T2-A	3k pcs./reel

THERMAL RESISTANCE

SYMBOLS	PARAMETERS	UNITS	RATINGS
R _{th j-a}	Thermal Resistance from Junction to Ambient	°C/W	600

Note:

- Mounted on a 1.08cm² x 1.0 mm thick glass epoxy PCB.

TYPICAL PERFORMANCE CURVES (T_A = 25 °C)

TOTAL POWER DISSIPATION vs. AMBIENT TEMPERATURE

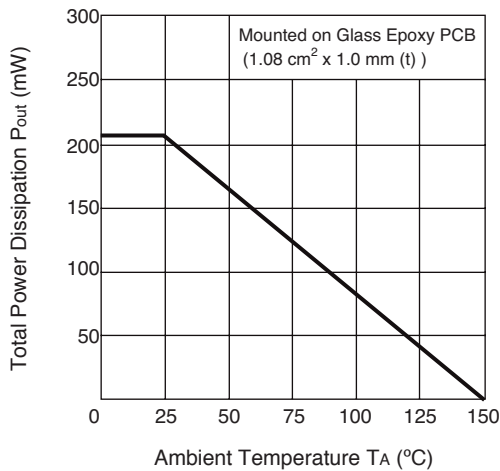

REVERSE TRANSFER CAPACITANCE vs. COLLECTOR TO BASE VOLTAGE

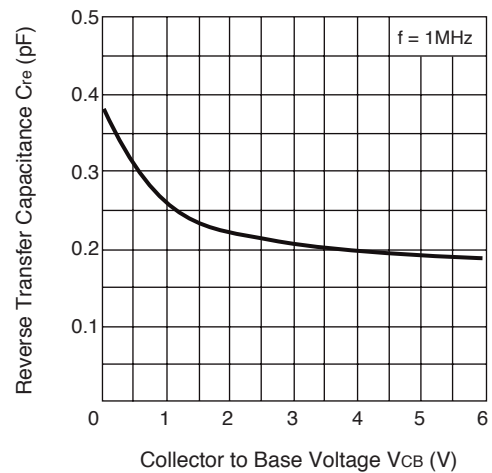

COLLECTOR CURRENT vs. COLLECTOR TO EMITTER VOLTAGE

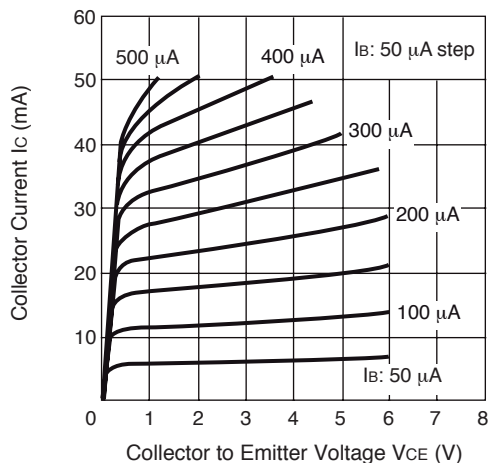

DC CURRENT GAIN vs. COLLECTOR CURRENT

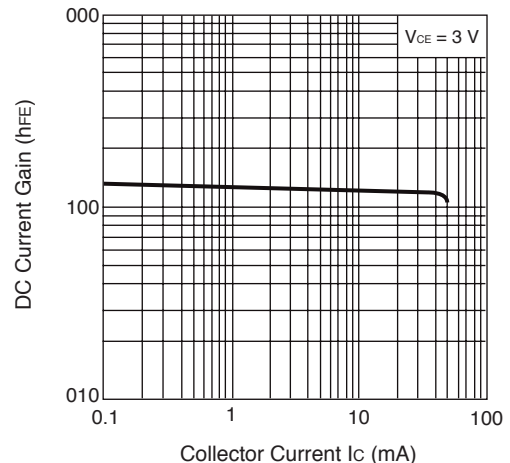

TYPICAL PERFORMANCE CURVES (TA = 25 °C)

GAIN BANDWIDTH PRODUCT vs. COLLECTOR CURRENT

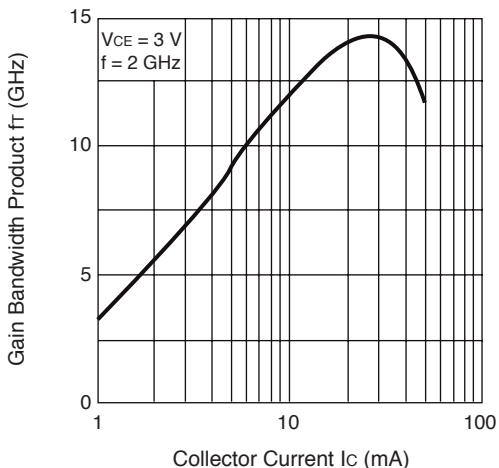

INSERTION POWER GAIN, MAG, MSG vs. FREQUENCY

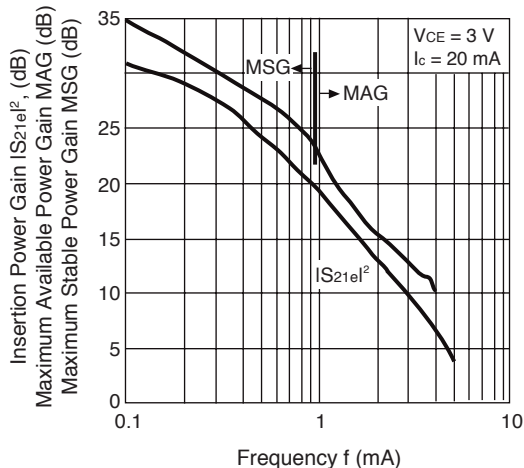

INSERTION POWER GAIN, MAG, MSG vs. COLLECTOR CURRENT

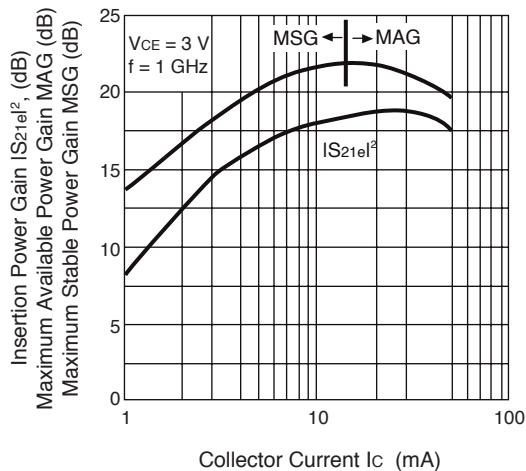

INSERTION POWER GAIN, MAG, MSG vs. COLLECTOR CURRENT

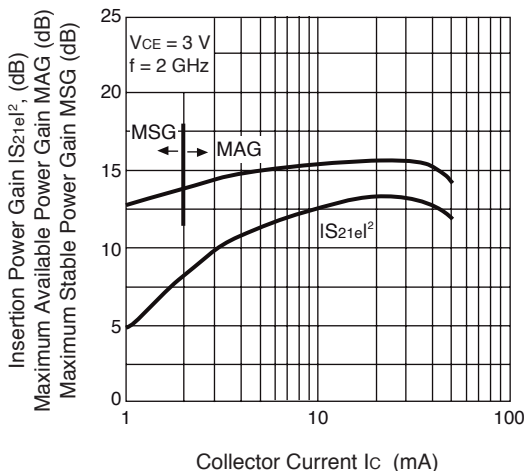

INSERTION POWER GAIN, MAG vs. COLLECTOR CURRENT

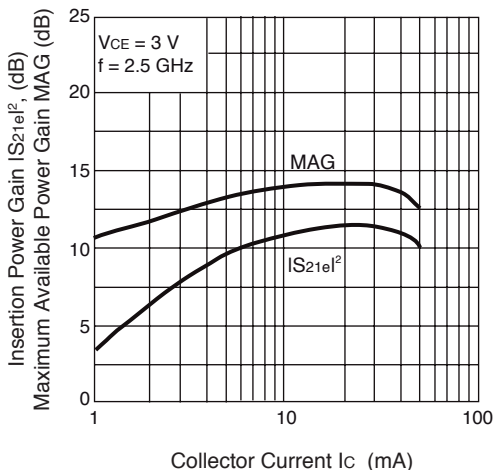

NOISE FIGURE, ASSOCIATED GAIN vs. COLLECTOR CURRENT

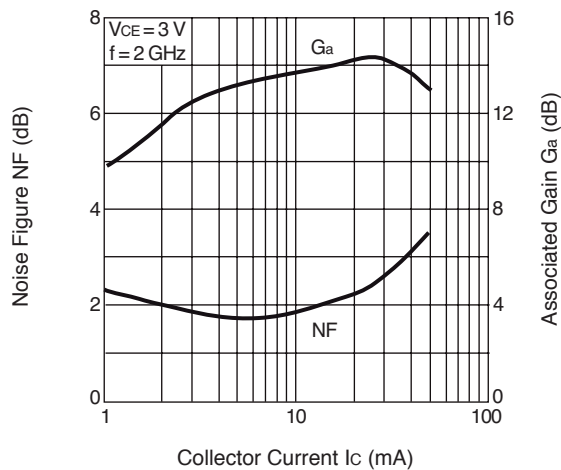

TYPICAL PERFORMANCE CURVES (TA = 25 °C)

OUTPUT POWER, POWER GAIN, COLLECTOR CURRENT, COLLECTOR EFFICIENCY vs. INPUT POWER

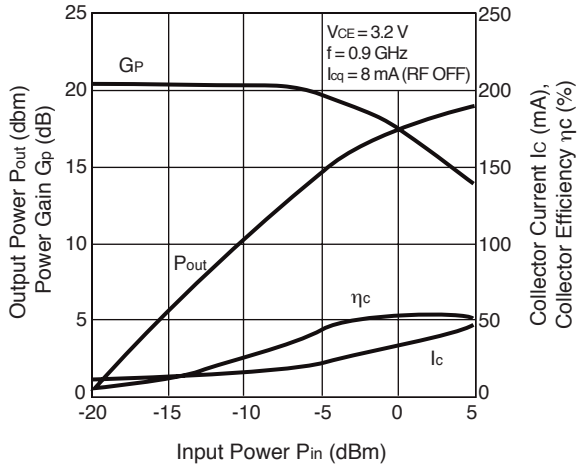

OUTPUT POWER, POWER GAIN, COLLECTOR CURRENT, COLLECTOR EFFICIENCY vs. INPUT POWER

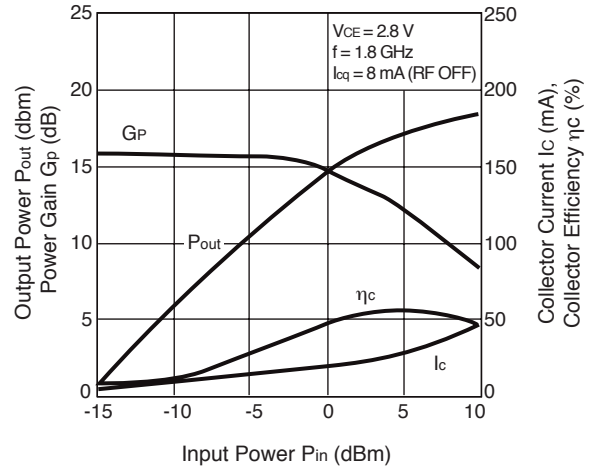

OUTPUT POWER, POWER GAIN, COLLECTOR CURRENT, COLLECTOR EFFICIENCY vs. INPUT POWER

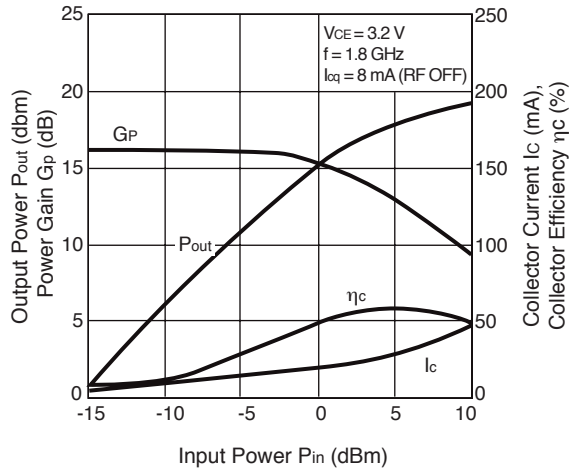

OUTPUT POWER, POWER GAIN, COLLECTOR CURRENT, COLLECTOR EFFICIENCY vs. INPUT POWER

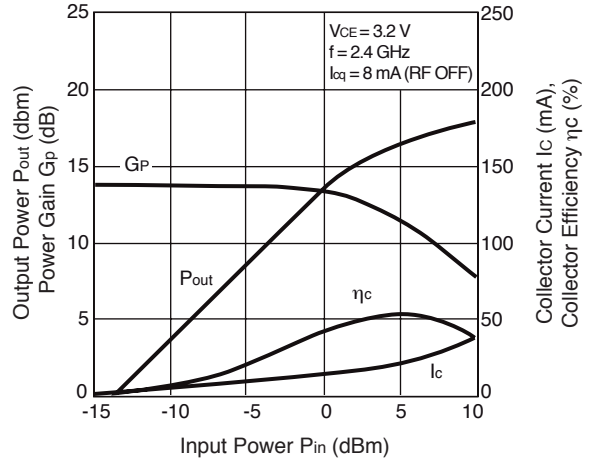

TYPICAL SCATTERING PARAMETERS (TA = 25°C)

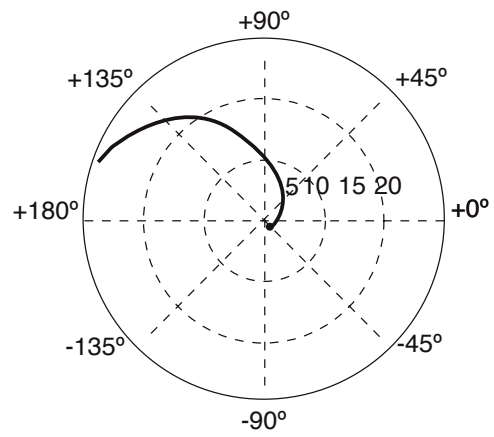
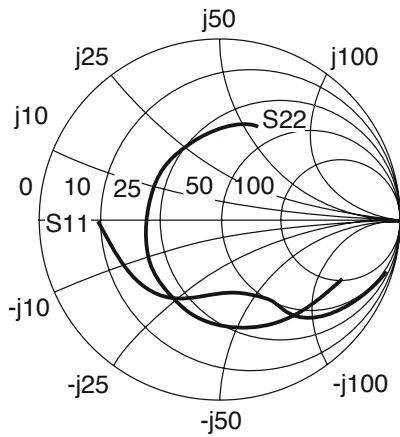

NE677M04

Vc = 2 V, Ic = 10 mA

FREQUENCY GHz	S11		S21		S12		S22		K	MAG ¹ (dB)
	MAG	ANG	MAG	ANG	MAG	ANG	MAG	ANG		
0.100	0.72	-28.02	23.85	159.39	0.01	76.80	0.94	-17.17	0.11	32.34
0.200	0.67	-53.32	21.19	142.90	0.02	61.76	0.85	-30.90	0.22	29.46
0.300	0.62	-74.47	18.36	129.52	0.03	53.97	0.75	-41.48	0.30	27.71
0.400	0.57	-91.69	15.78	119.03	0.04	47.84	0.66	-49.21	0.38	26.40
0.500	0.54	-105.42	13.68	110.66	0.04	44.49	0.60	-55.01	0.46	25.44
0.600	0.50	-119.13	11.77	103.58	0.04	41.61	0.51	-57.12	0.62	24.54
0.700	0.48	-128.64	10.42	97.78	0.04	40.18	0.48	-61.53	0.69	23.81
0.800	0.47	-136.17	9.33	92.96	0.05	39.74	0.45	-63.91	0.75	23.13
0.900	0.46	-143.27	8.43	88.43	0.05	39.29	0.43	-66.99	0.82	22.51
1.000	0.46	-148.66	7.70	84.44	0.05	39.40	0.42	-69.40	0.87	21.95
1.500	0.44	-170.56	5.30	67.31	0.06	40.48	0.39	-82.07	1.10	17.66
1.800	0.43	179.75	4.47	58.55	0.06	41.76	0.39	-89.26	1.19	15.82
1.900	0.43	176.51	4.24	55.72	0.07	41.66	0.39	-91.76	1.20	15.33
2.000	0.43	173.63	4.04	52.97	0.07	42.00	0.40	-94.18	1.22	14.87
2.500	0.42	159.00	3.26	39.73	0.08	42.28	0.42	-105.45	1.26	13.00
3.000	0.42	144.48	2.73	27.19	0.10	40.73	0.46	-115.95	1.24	11.64
3.500	0.43	129.44	2.34	15.06	0.11	38.24	0.49	-125.23	1.18	10.67
4.000	0.45	115.14	2.04	3.42	0.13	34.92	0.53	-134.51	1.11	9.99
4.500	0.48	102.37	1.79	-7.89	0.14	30.39	0.56	-144.23	1.04	9.71
5.000	0.50	91.32	1.59	-18.83	0.16	25.33	0.59	-154.88	0.97	9.94
5.500	0.53	81.53	1.42	-29.44	0.18	19.49	0.62	-165.89	0.90	9.00
6.000	0.55	72.28	1.27	-39.61	0.20	13.49	0.66	-176.84	0.85	8.11

Note:

1. Gain Calculations:

$$MAG = \frac{|S_{21}|}{|S_{12}|} (K - \sqrt{K^2 - 1}). \text{ When } K \geq 1, \text{ MAG is undefined and MSG values are used. } MSG = \frac{|S_{21}|}{|S_{12}|}, K = \frac{1 + |\Delta|^2 - |S_{11}|^2 - |S_{22}|^2}{2 |S_{12}| |S_{21}|}, \Delta = S_{11} S_{22} - S_{21} S_{12}$$

MAG = Maximum Available Gain
MSG = Maximum Stable Gain

NE677M04

TYPICAL SCATTERING PARAMETERS (TA = 25°C)

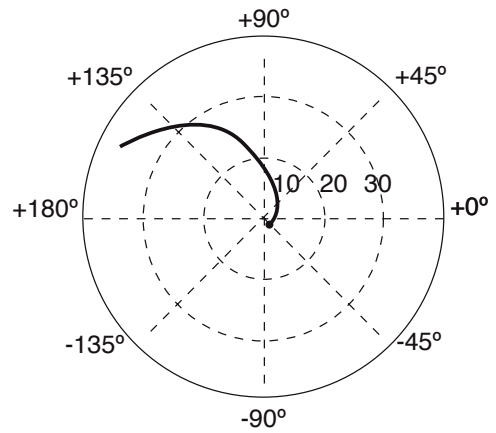
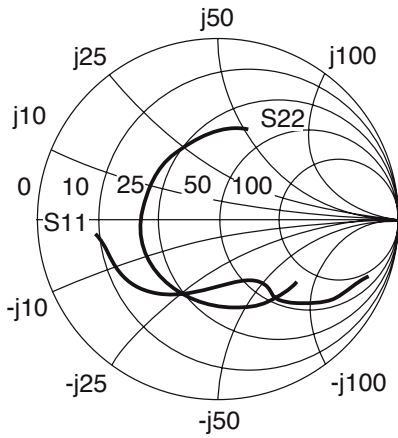

NE677M04

Vc = 3 V, Ic = 20 mA

FREQUENCY GHz	S11		S21		S12		S22		K	MAG ¹ (dB)
	MAG	ANG	MAG	ANG	MAG	ANG	MAG	ANG		
0.100	0.58	-36.91	34.82	154.30	0.01	65.53	0.91	-19.74	0.28	35.64
0.200	0.53	-67.97	29.03	135.74	0.02	59.98	0.78	-33.77	0.34	32.23
0.300	0.49	-91.49	23.80	122.19	0.02	55.05	0.67	-43.13	0.45	30.35
0.400	0.46	-108.88	19.70	112.29	0.03	51.06	0.58	-49.18	0.56	28.90
0.500	0.44	-121.87	16.66	104.71	0.03	49.50	0.52	-53.43	0.65	27.72
0.600	0.42	-135.00	14.16	98.54	0.03	48.74	0.45	-53.84	0.81	26.72
0.700	0.42	-143.29	12.41	93.35	0.03	49.30	0.42	-57.21	0.89	25.86
0.800	0.41	-149.68	11.03	89.03	0.03	50.12	0.40	-58.72	0.95	25.08
0.900	0.41	-155.84	9.91	84.93	0.04	50.69	0.39	-61.16	0.99	24.32
1.000	0.41	-160.23	9.01	81.35	0.04	51.41	0.38	-63.04	1.04	22.48
1.500	0.40	-178.96	6.14	65.55	0.05	53.28	0.37	-74.89	1.17	18.28
1.800	0.39	172.52	5.16	57.30	0.06	53.31	0.38	-82.12	1.20	16.70
1.900	0.39	169.64	4.90	54.62	0.06	53.31	0.38	-84.61	1.20	16.25
2.000	0.39	167.05	4.66	52.02	0.06	53.16	0.38	-87.15	1.21	15.82
2.500	0.39	153.59	3.75	39.33	0.08	51.37	0.42	-98.84	1.19	14.09
3.000	0.39	139.95	3.14	27.21	0.10	48.43	0.45	-109.77	1.15	12.83
3.500	0.41	125.64	2.68	15.39	0.11	44.68	0.49	-119.46	1.09	12.00
4.000	0.43	111.98	2.34	3.97	0.13	40.02	0.53	-129.07	1.02	11.72
4.500	0.45	99.88	2.06	-7.19	0.15	34.90	0.56	-139.11	0.95	11.48
5.000	0.48	89.38	1.83	-18.07	0.16	29.26	0.60	-150.00	0.88	10.49
5.500	0.51	80.01	1.64	-28.76	0.18	22.90	0.63	-161.27	0.82	9.55
6.000	0.53	71.10	1.47	-39.12	0.20	16.56	0.66	-172.54	0.77	8.69

Note:

1. Gain Calculations:

$$\text{MAG} = \frac{|S_{21}|}{|S_{12}|} \left(K - \sqrt{K^2 - 1} \right). \text{ When } K \geq 1, \text{ MAG is undefined and MSG values are used. } \text{MSG} = \frac{|S_{21}|}{|S_{12}|}, K = \frac{1 + |\Delta|^2 - |S_{11}|^2 - |S_{22}|^2}{2 |S_{12}| |S_{21}|}, \Delta = S_{11} S_{22} - S_{21} S_{12}$$

MAG = Maximum Available Gain

MSG = Maximum Stable Gain

TYPICAL SCATTERING PARAMETERS (T_A = 25°C)

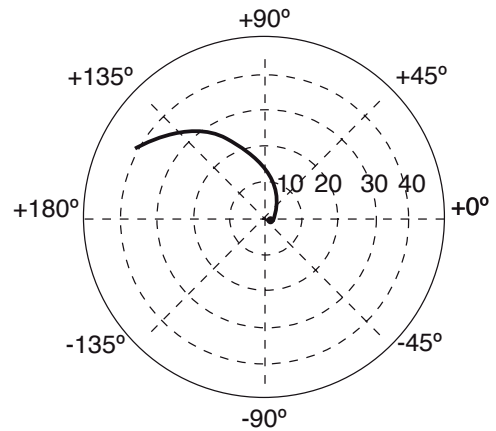
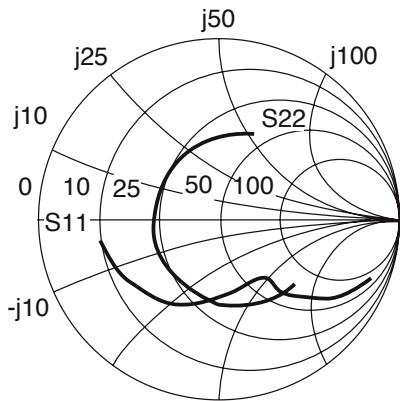

NE677M04

V_c = 5 V, I_c = 30 mA

FREQUENCY GHz	S ₁₁		S ₂₁		S ₁₂		S ₂₂		K	MAG ¹ (dB)
	MAG	ANG	MAG	ANG	MAG	ANG	MAG	ANG		
0.100	0.53	-41.03	40.66	151.83	0.01	79.56	0.89	-20.30	0.21	36.62
0.200	0.48	-73.66	32.81	132.70	0.02	64.08	0.75	-33.75	0.39	33.32
0.300	0.44	-97.50	26.31	119.35	0.02	56.29	0.63	-42.07	0.53	31.43
0.400	0.42	-114.52	21.49	109.81	0.02	53.44	0.56	-47.07	0.66	30.03
0.500	0.41	-127.00	18.03	102.57	0.02	53.31	0.50	-50.52	0.75	28.75
0.600	0.39	-139.82	15.28	96.73	0.03	53.08	0.43	-50.09	0.90	27.65
0.700	0.39	-147.57	13.34	91.78	0.03	54.05	0.41	-52.99	0.98	26.75
0.800	0.38	-153.47	11.83	87.64	0.03	55.02	0.40	-54.21	1.02	24.98
0.900	0.38	-159.31	10.62	83.69	0.03	55.65	0.39	-56.48	1.06	23.55
1.000	0.38	-163.26	9.64	80.25	0.04	56.16	0.38	-58.27	1.09	22.49
1.500	0.37	-179.14	6.55	64.91	0.05	58.22	0.37	-70.16	1.18	18.69
1.800	0.37	-171.01	5.50	56.83	0.06	57.93	0.38	-77.47	1.19	17.16
1.900	0.37	-168.30	5.22	54.20	0.06	57.51	0.39	-80.11	1.20	16.71
2.000	0.37	-165.83	4.96	51.65	0.06	57.41	0.39	-82.71	1.20	16.30
2.500	0.37	-152.63	3.99	39.13	0.08	54.90	0.43	-94.79	1.17	14.62
3.000	0.37	-139.29	3.33	27.15	0.09	51.63	0.46	-106.02	1.12	13.43
3.500	0.38	-125.14	2.85	15.43	0.11	47.27	0.50	-116.01	1.05	12.75
4.000	0.40	-111.70	2.49	4.05	0.13	42.60	0.54	-125.90	0.99	12.91
4.500	0.43	-99.67	2.19	-7.08	0.15	37.08	0.58	-136.09	0.91	11.79
5.000	0.46	-89.42	1.95	-17.99	0.16	31.31	0.61	-147.22	0.84	10.78
5.500	0.49	-80.22	1.74	-28.73	0.18	25.13	0.65	-158.70	0.78	9.86
6.000	0.51	-71.38	1.56	-39.19	0.20	18.62	0.68	-170.08	0.73	8.98

Note:

1. Gain Calculations:

$$MAG = \frac{|S_{21}|}{|S_{12}|} (K - \sqrt{K^2 - 1}). \text{ When } K \geq 1, \text{ MAG is undefined and MSG values are used. } MSG = \frac{|S_{21}|}{|S_{12}|}, K = \frac{1 + |\Delta|^2 - |S_{11}|^2 - |S_{22}|^2}{2 |S_{12}| |S_{21}|}, \Delta = S_{11} S_{22} - S_{21} S_{12}$$

MAG = Maximum Available Gain

MSG = Maximum Stable Gain

Life Support Applications

These NEC products are not intended for use in life support devices, appliances, or systems where the malfunction of these products can reasonably be expected to result in personal injury. The customers of CEL using or selling these products for use in such applications do so at their own risk and agree to fully indemnify CEL for all damages resulting from such improper use or sale.

Subject: Compliance with EU Directives

CEL certifies, to its knowledge, that semiconductor and laser products detailed below are compliant with the requirements of European Union (EU) Directive 2002/95/EC Restriction on Use of Hazardous Substances in electrical and electronic equipment (RoHS) and the requirements of EU Directive 2003/11/EC Restriction on Penta and Octa BDE.

CEL Pb-free products have the same base part number with a suffix added. The suffix –A indicates that the device is Pb-free. The –AZ suffix is used to designate devices containing Pb which are exempted from the requirement of RoHS directive (*). In all cases the devices have Pb-free terminals. All devices with these suffixes meet the requirements of the RoHS directive.

This status is based on CEL’s understanding of the EU Directives and knowledge of the materials that go into its products as of the date of disclosure of this information.

Restricted Substance per RoHS	Concentration Limit per RoHS (values are not yet fixed)	Concentration contained in CEL devices	
		-A	-AZ
Lead (Pb)	< 1000 PPM	Not Detected	(*)
Mercury	< 1000 PPM	Not Detected	
Cadmium	< 100 PPM	Not Detected	
Hexavalent Chromium	< 1000 PPM	Not Detected	
PBB	< 1000 PPM	Not Detected	
PBDE	< 1000 PPM	Not Detected	

If you should have any additional questions regarding our devices and compliance to environmental standards, please do not hesitate to contact your local representative.

Important Information and Disclaimer: Information provided by CEL on its website or in other communications concerning the substance content of its products represents knowledge and belief as of the date that it is provided. CEL bases its knowledge and belief on information provided by third parties and makes no representation or warranty as to the accuracy of such information. Efforts are underway to better integrate information from third parties. CEL has taken and continues to take reasonable steps to provide representative and accurate information but may not have conducted destructive testing or chemical analysis on incoming materials and chemicals. CEL and CEL suppliers consider certain information to be proprietary, and thus CAS numbers and other limited information may not be available for release.

In no event shall CEL’s liability arising out of such information exceed the total purchase price of the CEL part(s) at issue sold by CEL to customer on an annual basis.

See CEL Terms and Conditions for additional clarification of warranties and liability.