

### FEATURES

- **NEW MINIATURE M03 PACKAGE:**
  - Small transistor outline
  - Low profile / 0.59 mm package height
  - Flat lead style for better RF performance
- **IDEAL FOR  $\leq 3$  GHz OSCILLATORS**
- **LOW 1/f NOISE**
- **LOW PUSHING FACTOR**

### DESCRIPTION

NEC's NE851M03 transistor is designed for oscillator applications up to 3 GHz. The NE851M03 features low voltage operation, low phase noise, and high immunity to pushing effects. NEC's low profile/flat lead style "M03" package is ideal for today's portable wireless applications.

### OUTLINE DIMENSIONS (Units in mm)

PACKAGE OUTLINE M03

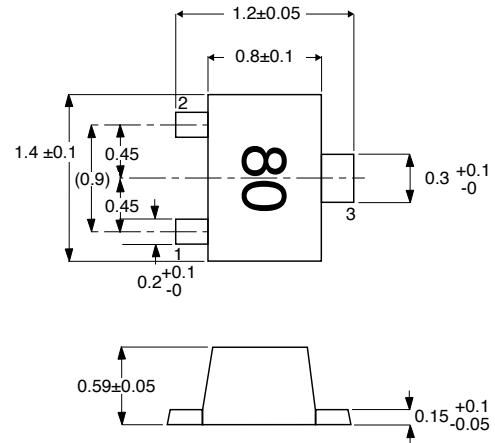

PIN CONNECTIONS

1. Emitter
2. Base
3. Collector

### ELECTRICAL CHARACTERISTICS (TA = 25°C)

PART NUMBER EIAJ <sup>1</sup> REGISTERED NUMBER PACKAGE OUTLINE		NE851M03 2SC5800 M03			
SYMBOLS	PARAMETERS AND CONDITIONS	UNITS	MIN	TYP	MAX
ft	Gain Bandwidth at VCE = 1 V, IC = 5 mA, f = 2 GHz	GHz	3.0	4.5	–
	at VCE = 1 V, IC = 15 mA, f = 2 GHz	GHz	5.0	6.5	–
IS21E1 <sup>2</sup>	Insertion Power Gain at VCE = 1 V, IC = 5 mA, f = 2 GHz	dB	3.0	4.0	–
	at VCE = 1 V, IC = 15 mA, f = 2 GHz	dB	4.5	5.5	–
NF	Noise Figure at VCE = 1 V, IC = 10 mA, f = 2 GHz, Zs = Zopt	dB	–	1.9	2.5
CRE	Reverse Transfer Capacitance <sup>3</sup> at VCB = 0.5 V, IE = 0 mA, f = 1 MHz	pF	–	0.6	0.8
ICBO	Collector Cutoff Current at VCB = 5 V, IE = 0	nA	–	–	600
IEBO	Emitter Cutoff Current at VEB = 1 V, IC = 0	nA	–	–	600
hFE	DC Current Gain <sup>2</sup> at VCE = 1 V, IC = 5 mA		100	120	145

Notes:

1. Electronic Industrial Association of Japan.
2. Pulsed measurement, pulse width  $\leq 350 \mu\text{s}$ , duty cycle  $\leq 2\%$ .
3. Collector to base capacitance when the emitter is grounded

**ABSOLUTE MAXIMUM RATINGS<sup>1</sup>** ( $T_A = 25^\circ\text{C}$ )

SYMBOLS	PARAMETERS	UNITS	RATINGS
$V_{CB0}$	Collector to Base Voltage	V	9.0
$V_{CE0}$	Collector to Emitter Voltage	V	5.5
$V_{EB0}$	Emitter to Base Voltage	V	1.5
$I_C$	Collector Current	mA	100
$P_T^2$	Total Power Dissipation	mW	200
$T_J$	Junction Temperature	$^\circ\text{C}$	150
$T_{STG}$	Storage Temperature	$^\circ\text{C}$	-65 to +150

Notes:

- Operation in excess of any one of these parameters may result in permanent damage.
- With device mounted on 1.08 cm<sup>2</sup> X 1.0 mm (t) glass epoxy board.

**ORDERING INFORMATION**

PART NUMBER	QUANTITY
NE851M03-T1-A	3 k pcs./reel

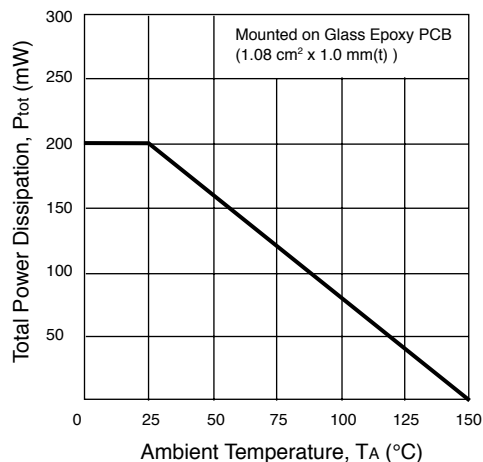
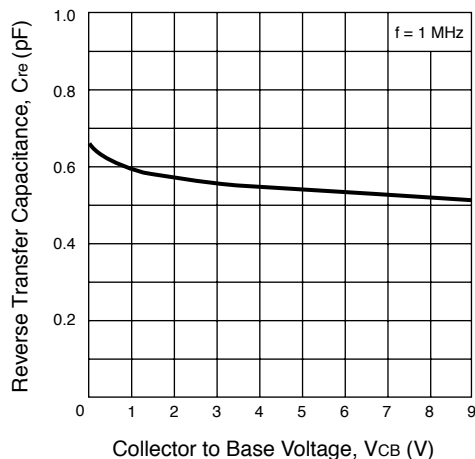
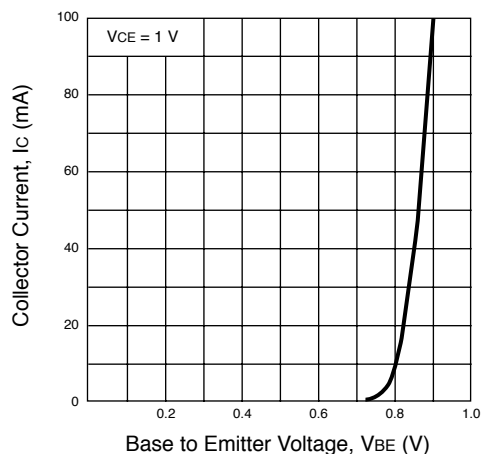
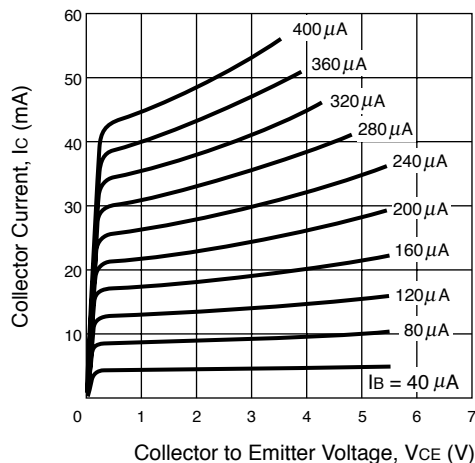
**TYPICAL PERFORMANCE CURVES** ( $T_A = 25^\circ\text{C}$ )**TOTAL POWER DISSIPATION vs. AMBIENT TEMPERATURE****REVERSE TRANSFER CAPACITANCE vs. COLLECTOR TO BASE VOLTAGE****COLLECTOR CURRENT vs. BASE TO EMITTER VOLTAGE****COLLECTOR CURRENT vs. COLLECTOR TO EMITTER VOLTAGE**

TYPICAL PERFORMANCE CURVES (TA = 25°C)

GAIN BANDWIDTH PRODUCT vs. COLLECTOR CURRENT

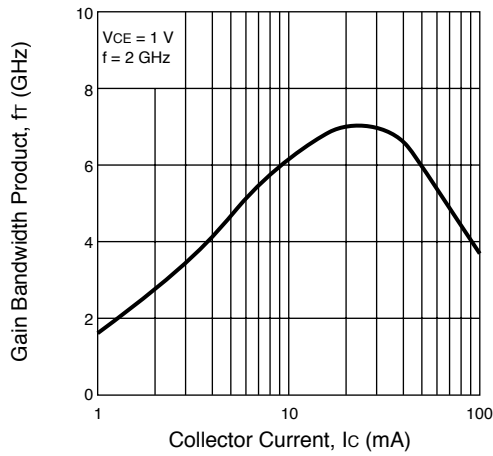

GAIN BANDWIDTH PRODUCT vs. COLLECTOR CURRENT

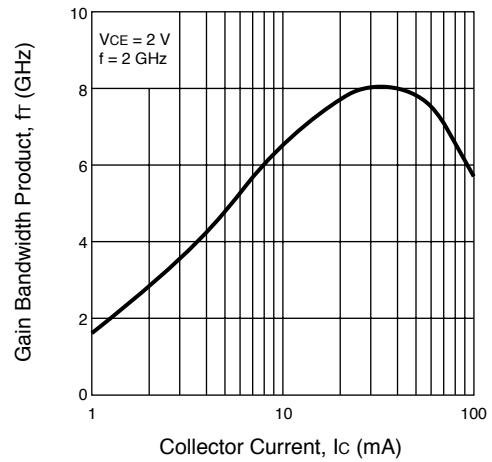

INSERTION POWER GAIN vs. FREQUENCY

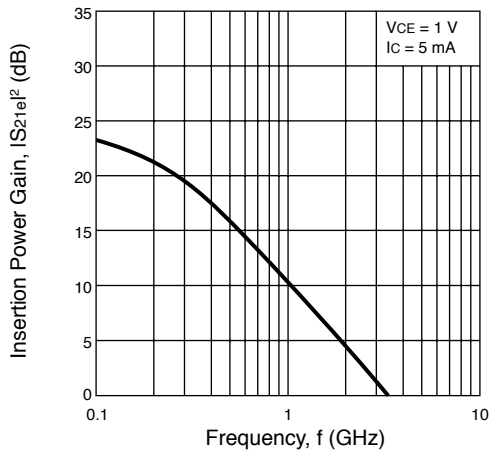

INSERTION POWER GAIN vs. FREQUENCY

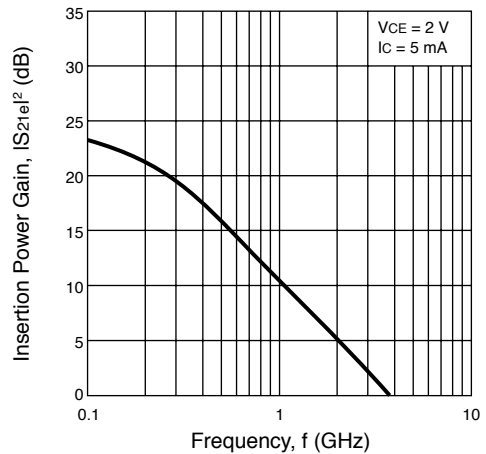

INSERTION POWER GAIN vs. FREQUENCY

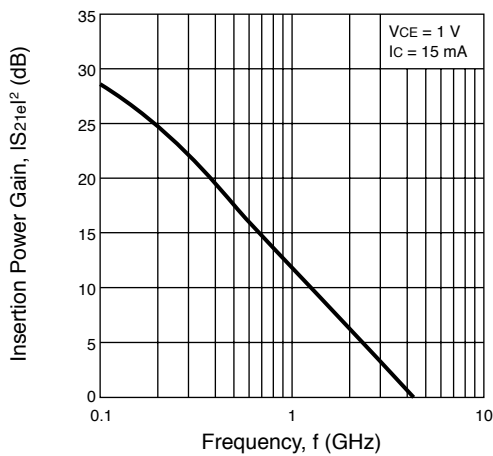

INSERTION POWER GAIN vs. FREQUENCY

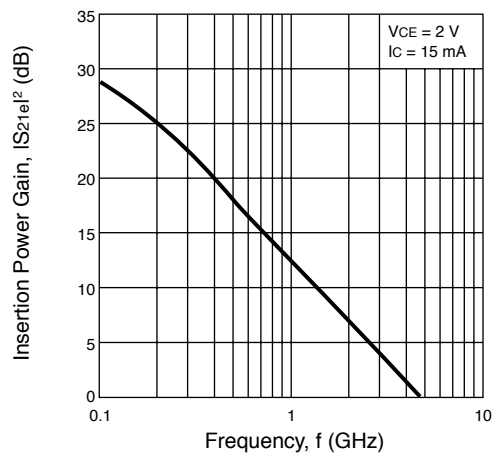

TYPICAL PERFORMANCE CURVES (T<sub>A</sub> = 25°C)

INSERTION POWER GAIN, MAG, MSG vs. COLLECTOR CURRENT

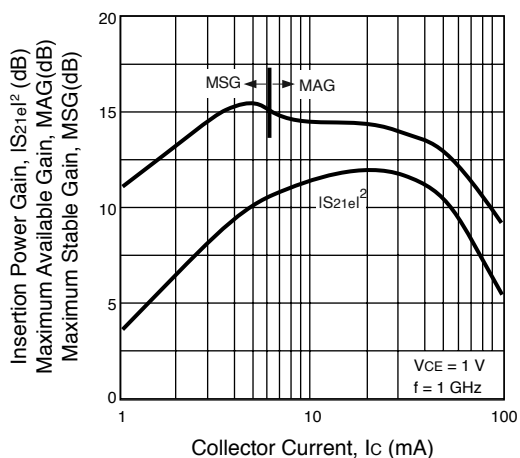

INSERTION POWER GAIN, MAG, MSG vs. COLLECTOR CURRENT

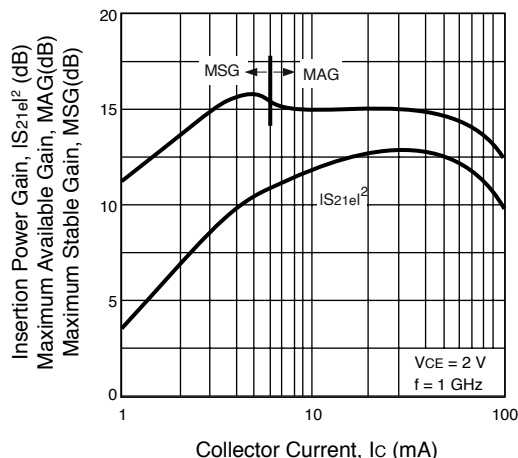

INSERTION POWER GAIN and MAG vs. COLLECTOR CURRENT

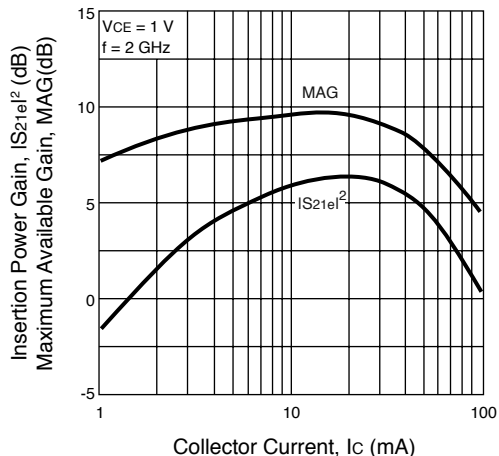

INSERTION POWER GAIN and MAG vs. COLLECTOR CURRENT

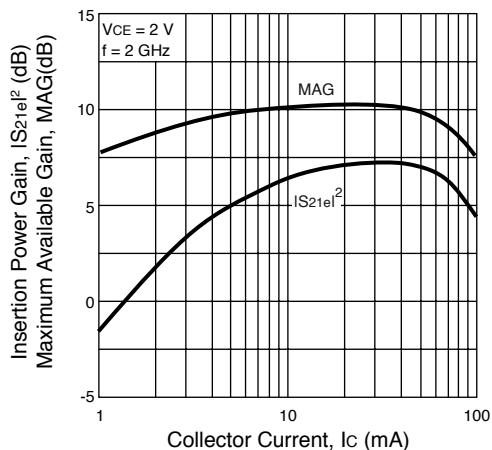

INSERTION POWER GAIN, MAG, MSG vs. COLLECTOR CURRENT

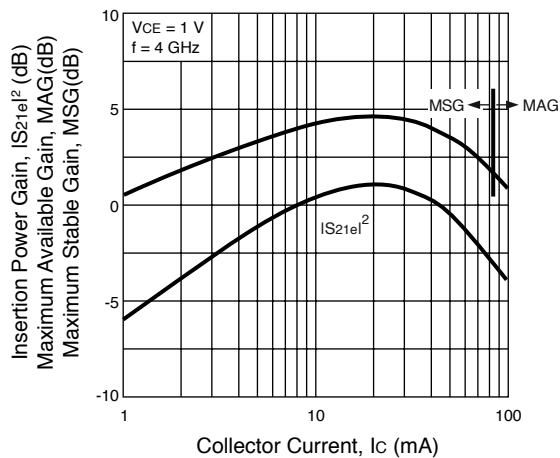

INSERTION POWER GAIN, MSG vs. COLLECTOR CURRENT

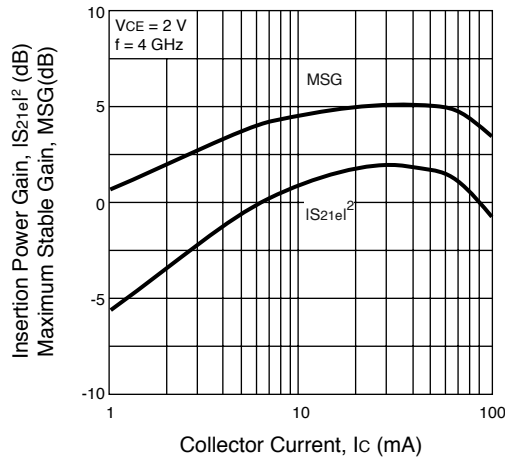

TYPICAL PERFORMANCE CURVES (T<sub>A</sub> = 25°C)

NOISE FIGURE and ASSOCIATED GAIN vs. COLLECTOR CURRENT

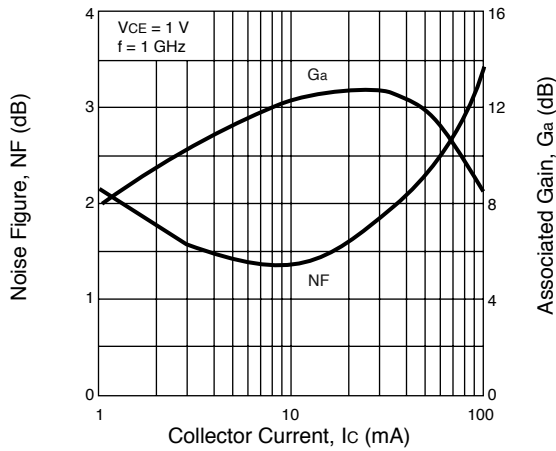

NOISE FIGURE and ASSOCIATED GAIN vs. COLLECTOR CURRENT

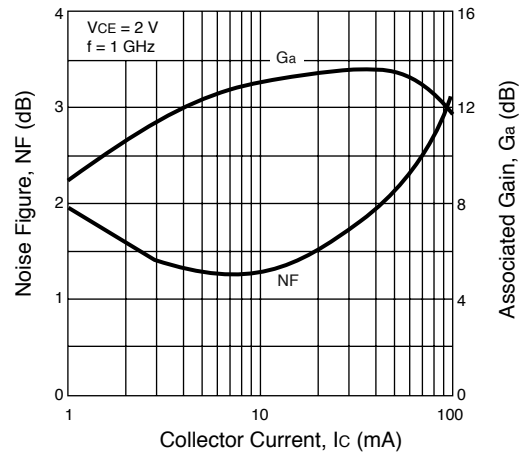

NOISE FIGURE and ASSOCIATED GAIN vs. COLLECTOR CURRENT

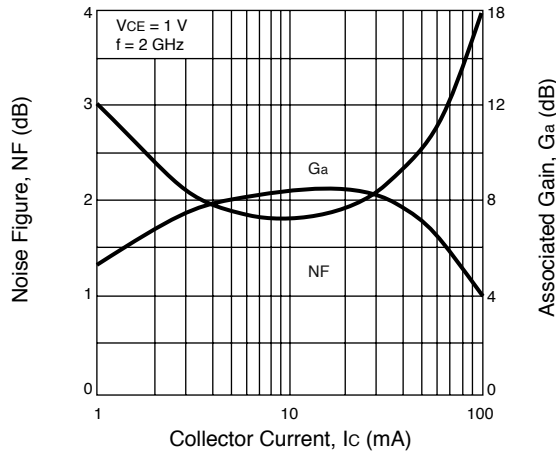

NOISE FIGURE and ASSOCIATED GAIN vs. COLLECTOR CURRENT

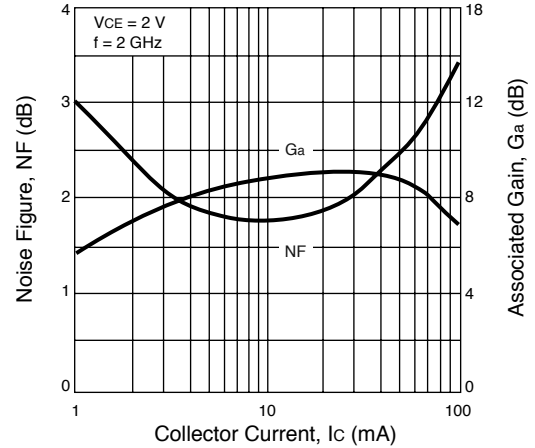

OUTPUT POWER AND COLLECTOR CURRENT vs. INPUT POWER

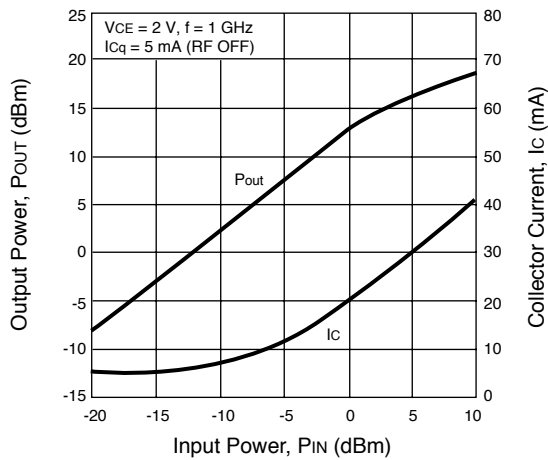

OUTPUT POWER AND COLLECTOR CURRENT vs. INPUT POWER

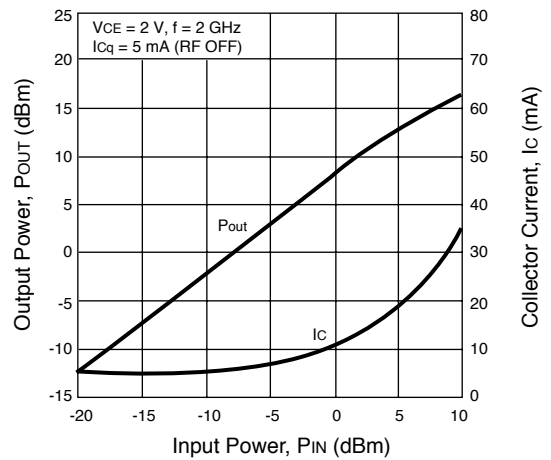

**TYPICAL SCATTERING PARAMETERS** (TA = 25°C)

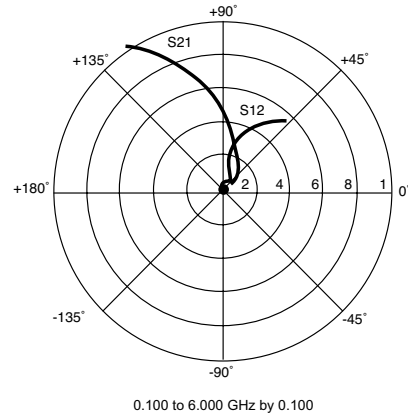
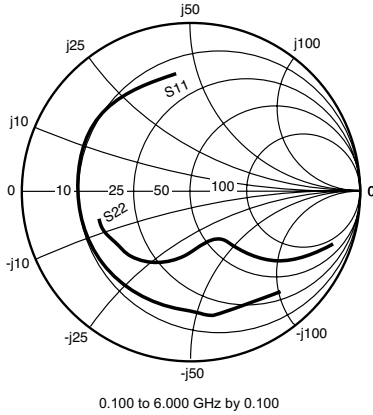

**NE851M03**  
**Vc = 1 V, Ic = 5 mA**

FREQUENCY GHz	S11		S21		S12		S22		K	MAG <sup>1</sup> (dB)
	MAG	ANG	MAG	ANG	MAG	ANG	MAG	ANG		
0.100	0.824	-46.13	13.999	152.23	0.033	66.48	0.903	-21.08	0.089	26.32
0.200	0.748	-80.11	11.531	131.89	0.051	52.70	0.745	-34.82	0.187	23.51
0.300	0.705	-104.73	9.279	118.04	0.062	43.78	0.620	-42.24	0.283	21.75
0.400	0.679	-121.76	7.580	108.36	0.067	39.96	0.537	-46.40	0.368	20.54
0.500	0.673	-141.72	6.194	98.80	0.068	35.59	0.410	-53.91	0.510	19.57
0.700	0.666	-155.88	4.587	89.15	0.072	37.14	0.356	-57.66	0.677	18.03
1.000	0.664	-168.35	3.313	78.69	0.078	43.34	0.331	-62.07	0.872	16.26
1.100	0.665	-171.53	3.030	75.69	0.081	45.75	0.327	-64.09	0.924	15.75
1.200	0.664	-174.29	2.794	72.95	0.083	48.31	0.325	-65.91	0.976	15.26
1.300	0.665	-176.88	2.593	70.20	0.086	51.04	0.326	-68.31	1.010	14.15
1.400	0.664	-179.25	2.424	67.64	0.090	53.34	0.329	-70.20	1.039	13.11
1.500	0.665	178.52	2.274	65.18	0.094	55.84	0.332	-72.21	1.056	12.40
1.600	0.666	176.60	2.145	62.84	0.098	58.31	0.335	-74.41	1.065	11.82
1.700	0.666	174.50	2.029	60.56	0.103	60.46	0.340	-76.60	1.071	11.31
1.800	0.666	172.69	1.928	58.37	0.109	62.48	0.345	-78.64	1.066	10.91
1.900	0.666	170.70	1.835	56.25	0.115	64.26	0.351	-80.85	1.064	10.49
2.000	0.666	169.07	1.754	54.18	0.121	66.01	0.356	-83.15	1.056	10.17
2.100	0.667	167.34	1.677	52.01	0.128	67.42	0.362	-85.49	1.039	9.96
2.200	0.667	165.53	1.610	50.17	0.135	68.65	0.370	-87.59	1.021	9.87
2.300	0.667	163.82	1.548	48.31	0.143	69.81	0.377	-89.58	1.004	9.96
2.400	0.668	162.04	1.491	46.50	0.152	70.84	0.383	-91.66	0.983	9.93
2.500	0.669	160.31	1.440	44.69	0.160	71.44	0.391	-93.66	0.959	9.53
2.600	0.669	158.48	1.391	42.95	0.169	72.05	0.397	-95.62	0.944	9.15
2.700	0.670	156.71	1.347	41.25	0.179	72.44	0.405	-97.78	0.920	8.77
2.800	0.669	154.91	1.305	39.67	0.189	72.75	0.412	-99.60	0.903	8.39
2.900	0.669	152.89	1.265	38.08	0.199	72.87	0.420	-101.42	0.888	8.03
3.000	0.671	151.05	1.228	36.56	0.209	72.79	0.427	-103.43	0.868	7.68
3.500	0.670	141.05	1.075	29.73	0.266	71.32	0.463	-112.30	0.808	6.07
4.000	0.672	130.96	0.959	24.15	0.326	67.81	0.493	-121.04	0.775	4.69
4.500	0.671	120.95	0.870	19.76	0.387	62.94	0.518	-130.14	0.778	3.52
5.000	0.673	111.68	0.802	16.38	0.445	57.33	0.538	-139.86	0.798	2.56
5.500	0.675	103.60	0.752	13.83	0.498	51.29	0.553	-150.11	0.830	1.79
6.000	0.680	96.09	0.718	11.88	0.545	45.24	0.563	-160.44	0.865	1.19

Note:

1. Gain Calculations:

$$MAG = \frac{|S_{21}|}{|S_{12}|} (K \pm \sqrt{K^2 - 1}). \text{ When } K \leq 1, \text{ MAG is undefined and MSG values are used. } MSG = \frac{|S_{21}|}{|S_{12}|}, K = \frac{1 + |\Delta|^2 - |S_{11}|^2 - |S_{22}|^2}{2 |S_{12} S_{21}|}, \Delta = S_{11} S_{22} - S_{21} S_{12}$$

MAG = Maximum Available Gain

MSG = Maximum Stable Gain

# NE851M03

## TYPICAL SCATTERING PARAMETERS (T<sub>A</sub> = 25°C)

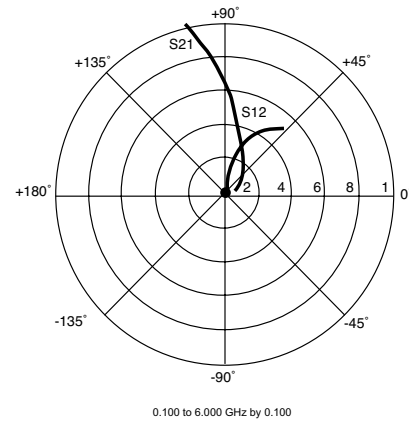
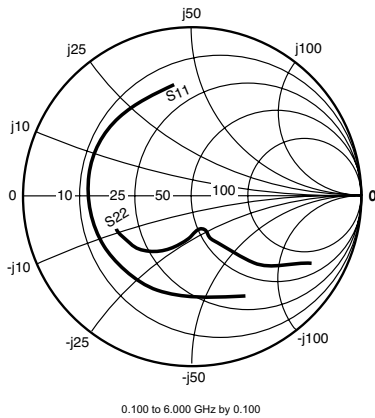

### NE851M03

V<sub>c</sub> = 2 V, I<sub>c</sub> = 10 mA

FREQUENCY GHz	S <sub>11</sub>		S <sub>21</sub>		S <sub>12</sub>		S <sub>22</sub>		K	MAG <sup>1</sup> (dB)
	MAG	ANG	MAG	ANG	MAG	ANG	MAG	ANG		
0.100	0.695	-61.64	23.158	144.21	0.026	61.44	0.821	-29.68	0.183	29.48
0.200	0.624	-100.58	17.024	122.63	0.038	50.73	0.610	-44.71	0.335	26.51
0.300	0.595	-123.61	12.782	110.30	0.044	47.67	0.480	-51.39	0.469	24.63
0.400	0.582	-137.95	10.071	102.30	0.049	47.72	0.405	-54.57	0.583	23.13
0.500	0.609	-154.61	8.021	95.02	0.052	47.72	0.289	-65.42	0.727	21.91
0.700	0.608	-165.54	5.858	87.23	0.060	52.69	0.245	-68.86	0.876	19.91
1.000	0.608	-175.12	4.192	78.55	0.075	59.31	0.226	-72.02	0.984	17.48
1.100	0.610	-177.63	3.830	76.03	0.080	61.10	0.223	-73.72	1.005	16.36
1.200	0.609	-179.89	3.528	73.70	0.086	62.79	0.221	-75.21	1.026	15.15
1.300	0.608	178.01	3.271	71.35	0.091	64.04	0.223	-77.34	1.039	14.33
1.400	0.608	176.04	3.057	69.13	0.097	65.34	0.226	-78.57	1.044	13.69
1.500	0.608	174.19	2.866	66.99	0.104	66.51	0.229	-80.20	1.045	13.12
1.600	0.609	172.64	2.703	64.95	0.110	67.27	0.232	-81.76	1.043	12.63
1.700	0.609	170.81	2.556	62.92	0.117	68.13	0.237	-83.43	1.040	12.18
1.800	0.608	169.29	2.429	60.94	0.124	68.82	0.241	-85.04	1.033	11.81
1.900	0.607	167.57	2.313	59.01	0.131	69.46	0.247	-86.60	1.027	11.45
2.000	0.606	166.16	2.211	57.16	0.138	70.00	0.252	-88.61	1.023	11.11
2.100	0.607	164.68	2.115	55.16	0.146	70.12	0.258	-90.25	1.011	10.96
2.200	0.606	163.12	2.031	53.46	0.154	70.56	0.266	-91.95	0.999	11.21
2.300	0.605	161.63	1.954	51.71	0.162	70.80	0.271	-93.42	0.990	10.82
2.400	0.606	160.05	1.884	50.01	0.170	70.94	0.278	-94.93	0.979	10.45
2.500	0.606	158.52	1.821	48.31	0.178	70.87	0.285	-96.56	0.966	10.10
2.600	0.605	156.89	1.760	46.64	0.186	70.86	0.291	-98.07	0.957	9.75
2.700	0.606	155.28	1.706	44.97	0.196	70.87	0.299	-99.75	0.941	9.41
2.800	0.604	153.71	1.654	43.40	0.205	70.66	0.306	-101.10	0.931	9.08
2.900	0.603	151.89	1.605	41.82	0.214	70.49	0.314	-102.50	0.922	8.76
3.000	0.604	150.23	1.561	40.28	0.223	69.98	0.321	-104.02	0.907	8.45
3.500	0.602	141.17	1.375	33.08	0.272	68.05	0.357	-111.13	0.862	7.04
4.000	0.604	131.89	1.233	26.63	0.323	64.75	0.391	-118.23	0.823	5.81
4.500	0.607	122.66	1.119	20.91	0.376	60.65	0.421	-126.11	0.805	4.73
5.000	0.614	114.03	1.026	15.94	0.428	55.85	0.448	-134.94	0.799	3.80
5.500	0.625	106.41	0.949	11.68	0.477	50.70	0.471	-144.72	0.805	2.99
6.000	0.638	99.10	0.887	8.19	0.523	45.37	0.489	-154.78	0.821	2.30

Note:

1. Gain Calculations:

$$MAG = \frac{|S_{21}|}{|S_{12}|} \left( K \pm \sqrt{K^2 - 1} \right). \text{ When } K \leq 1, \text{ MAG is undefined and MSG values are used. } MSG = \frac{|S_{21}|}{|S_{12}|}, K = \frac{1 + |\Delta|^2 - |S_{11}|^2 - |S_{22}|^2}{2 |S_{12} S_{21}|}, \Delta = S_{11} S_{22} - S_{21} S_{12}$$

MAG = Maximum Available Gain

MSG = Maximum Stable Gain

**TYPICAL SCATTERING PARAMETERS** (T<sub>A</sub> = 25°C)

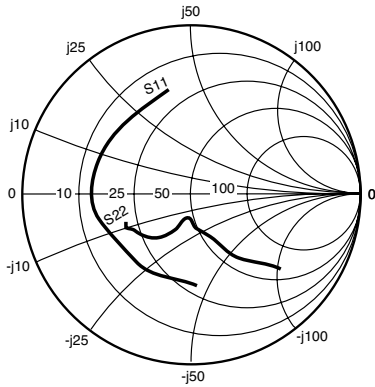

0.100 to 6.000 GHz by 0.100

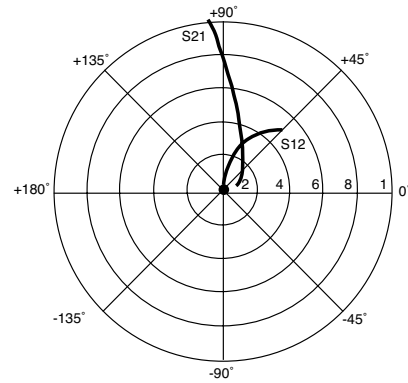

0.100 to 6.000 GHz by 0.100

**NE851M03**

V<sub>c</sub> = 3 V, I<sub>c</sub> = 20 mA

FREQUENCY	S <sub>11</sub>		S <sub>21</sub>		S <sub>12</sub>		S <sub>22</sub>		K	MAG <sup>1</sup>
GHz	MAG	ANG	MAG	ANG	MAG	ANG	MAG	ANG		(dB)
0.100	0.555	-83.93	33.100	134.57	0.020	59.16	0.705	-40.19	0.304	32.17
0.200	0.525	-123.08	21.477	114.01	0.028	53.63	0.469	-55.38	0.529	28.79
0.300	0.519	-141.74	15.332	103.82	0.035	55.51	0.355	-61.29	0.680	26.43
0.400	0.518	-152.59	11.824	97.41	0.040	58.95	0.295	-63.99	0.790	24.68
0.500	0.570	-165.20	9.286	91.94	0.045	60.56	0.203	-82.72	0.896	23.15
0.700	0.572	-173.28	6.730	85.52	0.058	64.80	0.170	-87.94	0.977	20.68
1.000	0.573	179.45	4.793	78.07	0.078	68.73	0.156	-90.92	1.020	17.03
1.100	0.574	177.46	4.376	75.85	0.085	69.69	0.154	-92.65	1.024	16.18
1.200	0.573	175.59	4.030	73.81	0.092	70.12	0.153	-93.73	1.032	15.34
1.300	0.573	173.85	3.736	71.72	0.099	70.66	0.156	-95.63	1.033	14.66
1.400	0.572	172.20	3.490	69.72	0.106	71.00	0.159	-96.09	1.031	14.09
1.500	0.572	170.60	3.272	67.80	0.113	71.20	0.162	-97.01	1.030	13.54
1.600	0.571	169.35	3.086	65.92	0.121	71.30	0.164	-97.84	1.027	13.07
1.700	0.571	167.72	2.918	64.09	0.129	71.48	0.169	-98.85	1.022	12.65
1.800	0.570	166.42	2.772	62.29	0.136	71.38	0.173	-99.61	1.018	12.28
1.900	0.568	164.85	2.641	60.52	0.144	71.29	0.177	-100.52	1.015	11.89
2.000	0.567	163.64	2.524	58.79	0.152	71.21	0.182	-101.75	1.010	11.61
2.100	0.566	162.32	2.415	56.94	0.160	71.07	0.188	-102.94	1.004	11.40
2.200	0.566	160.87	2.321	55.35	0.167	70.95	0.194	-103.84	0.997	11.42
2.300	0.564	159.57	2.233	53.71	0.176	70.63	0.200	-104.57	0.990	11.04
2.400	0.564	158.12	2.155	52.12	0.184	70.33	0.205	-105.29	0.982	10.69
2.500	0.563	156.71	2.082	50.51	0.192	69.89	0.212	-106.25	0.974	10.35
2.600	0.562	155.22	2.013	48.91	0.200	69.69	0.218	-107.15	0.968	10.02
2.700	0.562	153.77	1.953	47.33	0.209	69.30	0.225	-108.26	0.958	9.70
2.800	0.559	152.31	1.895	45.82	0.218	68.85	0.231	-108.94	0.952	9.39
2.900	0.558	150.61	1.840	44.30	0.227	68.41	0.238	-109.85	0.946	9.10
3.000	0.558	149.11	1.791	42.79	0.235	67.76	0.245	-110.73	0.937	8.82
3.500	0.554	140.64	1.583	35.66	0.280	65.12	0.280	-115.50	0.903	7.52
4.000	0.555	132.00	1.426	29.06	0.327	61.75	0.313	-120.66	0.870	6.39
4.500	0.558	123.35	1.300	22.97	0.374	57.82	0.345	-127.21	0.850	5.41
5.000	0.567	115.32	1.196	17.43	0.421	53.51	0.374	-134.94	0.834	4.54
5.500	0.581	108.18	1.109	12.40	0.465	48.92	0.400	-143.93	0.826	3.77
6.000	0.599	101.26	1.034	7.97	0.507	44.18	0.423	-153.49	0.828	3.09

Note:

1. Gain Calculations:

$$MAG = \frac{|S_{21}|}{|S_{12}|} \left( K \pm \sqrt{K^2 - 1} \right). \text{ When } K \leq 1, \text{ MAG is undefined and MSG values are used. } MSG = \frac{|S_{21}|}{|S_{12}|}, K = \frac{1 + |\Delta|^2 - |S_{11}|^2 - |S_{22}|^2}{2 |S_{12} S_{21}|}, \Delta = S_{11} S_{22} - S_{21} S_{12}$$

MAG = Maximum Available Gain

MSG = Maximum Stable Gain

Life Support Applications

These NEC products are not intended for use in life support devices, appliances, or systems where the malfunction of these products can reasonably be expected to result in personal injury. The customers of CEL using or selling these products for use in such applications do so at their own risk and agree to fully indemnify CEL for all damages resulting from such improper use or sale.

**CEL** California Eastern Laboratories, Your source for NEC RF, Microwave, Optoelectronic, and Fiber Optic Semiconductor Devices.

4590 Patrick Henry Drive • Santa Clara, CA 95054-1817 • (408) 988-3500 • FAX (408) 988-0279 • [www.cel.com](http://www.cel.com)

DATA SUBJECT TO CHANGE WITHOUT NOTICE

09/02/2003



**NONLINEAR MODEL**

**SCHEMATIC**

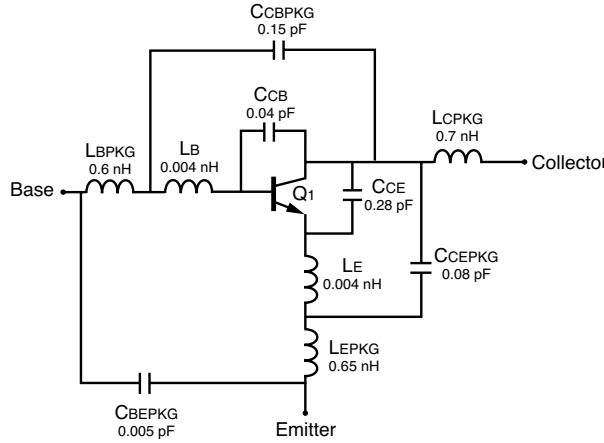

**BJT NONLINEAR MODEL PARAMETERS<sup>(1)</sup>**

Parameters	Q1	Parameters	Q1
IS	734.5e-18	MJC	0.122
BF	166.6	XCJC	0.1
NF	1.00	CJS	0
VAF	41	VJS	0.75
IKF	0.597	MJS	0
ISE	39.37e-15	FC	0.5
NE	2.258	TF	13e-12
BR	28.67	XTF	0.39
NR	1.000	VTF	0.668
VAR	2.541	ITF	0.06
IKR	23.22e-3	PTF	20
ISC	27.52e-18	TR	0
NC	2.0	EG	1.11
RE	1.7	XTB	0
RB	3.0	XTI	3
RBM	1.0	KF*	0
IRB	759e-6	AF*	1
RC	4.0		
CJE	2.51e-12		
VJE	0.887		
MJE	0.332		
CJC	498.2e-15		
VJC	0.367		

(1) Gummel-Poon Model

**ADDITIONAL PARAMETERS**

Parameters	NE851M03
CCB	0.04 pF
CCE	0.28 pF
LB	0.004 nH
LE	0.004 nH
CCBPKG	0.15 pF
CCEPKG	0.08 pF
CBEPKG	0.005 pF
LBPKG	0.6 nH
LCPKG	0.7 nH
LEPKG	0.65 nH

AF and KF are 1/f noise parameters and are bias dependent. The appropriate values for the 1/f noise parameters (AF and KF) shall be chosen from the table below, according to the desired current range.

	Ic = 5 mA	Ic = 10 mA	Ic = 15 mA
<b>AF</b>	1.40	2.551	2.626
<b>KF</b>	4.547e-15	855.6e-12	1.735e-9

For a better understanding on AF and KF parameters, please refer to AN1026.

**MODEL TEST CONDITIONS**

Frequency: 0.1 to 6.0 GHz  
 Bias: VCE = 1.5 V, Ic = 1 mA to 9 mA  
 Date: 09/2003

**Life Support Applications**

These NEC products are not intended for use in life support devices, appliances, or systems where the malfunction of these products can reasonably be expected to result in personal injury. The customers of CEL using or selling these products for use in such applications do so at their own risk and agree to fully indemnify CEL for all damages resulting from such improper use or sale.

**CEL** California Eastern Laboratories, Your source for NEC RF, Microwave, Optoelectronic, and Fiber Optic Semiconductor Devices.

4590 Patrick Henry Drive • Santa Clara, CA 95054-1817 • (408) 988-3500 • FAX (408) 988-0279 • [www.cel.com](http://www.cel.com)

DATA SUBJECT TO CHANGE WITHOUT NOTICE

09/02/2003

**NEC**  
 A Business Partner of NEC Compound Semiconductor Devices, Ltd.

Subject: Compliance with EU Directives

CEL certifies, to its knowledge, that semiconductor and laser products detailed below are compliant with the requirements of European Union (EU) Directive 2002/95/EC Restriction on Use of Hazardous Substances in electrical and electronic equipment (RoHS) and the requirements of EU Directive 2003/11/EC Restriction on Penta and Octa BDE.

CEL Pb-free products have the same base part number with a suffix added. The suffix –A indicates that the device is Pb-free. The –AZ suffix is used to designate devices containing Pb which are exempted from the requirement of RoHS directive (\*). In all cases the devices have Pb-free terminals. All devices with these suffixes meet the requirements of the RoHS directive.

This status is based on CEL’s understanding of the EU Directives and knowledge of the materials that go into its products as of the date of disclosure of this information.

Restricted Substance per RoHS	Concentration Limit per RoHS (values are not yet fixed)	Concentration contained in CEL devices	
		-A	-AZ
Lead (Pb)	< 1000 PPM	Not Detected	(*)
Mercury	< 1000 PPM	Not Detected	
Cadmium	< 100 PPM	Not Detected	
Hexavalent Chromium	< 1000 PPM	Not Detected	
PBB	< 1000 PPM	Not Detected	
PBDE	< 1000 PPM	Not Detected	

If you should have any additional questions regarding our devices and compliance to environmental standards, please do not hesitate to contact your local representative.

**Important Information and Disclaimer:** Information provided by CEL on its website or in other communications concerning the substance content of its products represents knowledge and belief as of the date that it is provided. CEL bases its knowledge and belief on information provided by third parties and makes no representation or warranty as to the accuracy of such information. Efforts are underway to better integrate information from third parties. CEL has taken and continues to take reasonable steps to provide representative and accurate information but may not have conducted destructive testing or chemical analysis on incoming materials and chemicals. CEL and CEL suppliers consider certain information to be proprietary, and thus CAS numbers and other limited information may not be available for release.

In no event shall CEL’s liability arising out of such information exceed the total purchase price of the CEL part(s) at issue sold by CEL to customer on an annual basis.

See CEL Terms and Conditions for additional clarification of warranties and liability.