



# NPN SILICON HIGH FREQUENCY TRANSISTOR

## UPA801T

### FEATURES

- **SMALL PACKAGE STYLE:**  
2 NE856 Die in a 2 mm x 1.25 mm package
- **LOW NOISE FIGURE:**  
NF = 1.2 dB TYP at 1 GHz
- **HIGH GAIN:**  
 $IS_{21E}I^2 = 9.0$  dB TYP at 1 GHz
- **HIGH COLLECTOR CURRENT:** 100mA

### DESCRIPTION

NEC's UPA801T is two NPN high frequency silicon epitaxial transistors encapsulated in an ultra small 6 pin SMT package. Each transistor is independently mounted and easily configured for either dual transistor or cascode operation. The high  $f_t$ , low voltage bias and small size make this device ideally suited for pager and other hand-held wireless applications.

### OUTLINE DIMENSIONS (Units in mm)

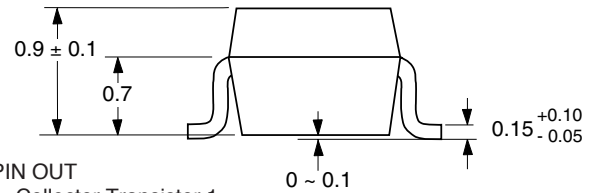
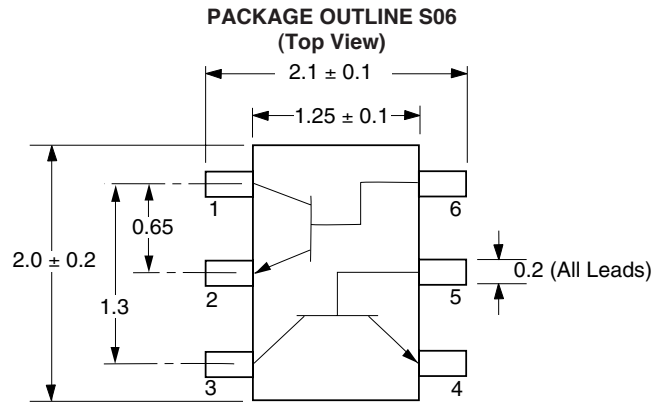

- PIN OUT
1. Collector Transistor 1
  2. Emitter Transistor 1
  3. Collector Transistor 2
  4. Emitter Transistor 2
  5. Base Transistor 2
  6. Base Transistor 1

Note:  
Pin 3 is identified with a circle on the bottom of the package.

### ELECTRICAL CHARACTERISTICS (T<sub>A</sub> = 25°C)

PART NUMBER PACKAGE OUTLINE			UPA801T S06		
SYMBOLS	PARAMETERS AND CONDITIONS	UNITS	MIN	TYP	MAX
I <sub>CBO</sub>	Collector Cutoff Current at V <sub>CB</sub> = 10 V, I <sub>E</sub> = 0	μA			1.0
I <sub>EBO</sub>	Emitter Cutoff Current at V <sub>EB</sub> = 1 V, I <sub>C</sub> = 0	μA			1.0
h <sub>FE</sub> <sup>1</sup>	Forward Current Gain at V <sub>CE</sub> = 3 V, I <sub>C</sub> = 7 mA		70	120	250
f <sub>T</sub>	Gain Bandwidth at V <sub>CE</sub> = 3 V, I <sub>C</sub> = 7 mA	GHz	3.0	4.5	
C <sub>re</sub> <sup>2</sup>	Feedback Capacitance at V <sub>CB</sub> = 3 V, I <sub>E</sub> = 0, f = 1 MHz	pF		0.7	1.5
IS <sub>21E</sub> I <sup>2</sup>	Insertion Power Gain at V <sub>CE</sub> = 3 V, I <sub>C</sub> = 7 mA, f = 1 GHz	dB	7	9	
NF	Noise Figure at V <sub>CE</sub> = 3 V, I <sub>C</sub> = 7 mA, f = 1 GHz	dB		1.2	2.5
h <sub>FE1</sub> /h <sub>FE2</sub>	h <sub>FE</sub> Ratio: h <sub>FE1</sub> = Smaller Value of Q <sub>1</sub> or Q <sub>2</sub> h <sub>FE2</sub> = Larger Value pf Q <sub>1</sub> or Q <sub>2</sub>		0.85		

Notes: 1. Pulsed measurement, pulse width ≤ 350 μs, duty cycle ≤ 2 %.  
2. The emitter terminal should be connected to the ground terminal of the 3 terminal capacitance bridge.  
For Tape and Reel version use part number UPA801T-T1, 3K per reel.

**ABSOLUTE MAXIMUM RATINGS<sup>1</sup>** ( $T_A = 25^\circ\text{C}$ )

SYMBOLS	PARAMETERS	UNITS	RATINGS
V <sub>CB0</sub>	Collector to Base Voltage	V	20
V <sub>CEO</sub>	Collector to Emitter Voltage	V	12
V <sub>EBO</sub>	Emitter to Base Voltage	V	3
I <sub>c</sub>	Collector Current	mA	100
P <sub>T</sub>	Total Power Dissipation		
	1 Die	mW	110
	2 Die	mW	200
T <sub>J</sub>	Junction Temperature	°C	150
T <sub>STG</sub>	Storage Temperature	°C	-65 to +150

Note: 1. Operation in excess of any one of these parameters may result in permanent damage.

**TYPICAL PERFORMANCE CURVES** ( $T_A = 25^\circ\text{C}$ )

**TOTAL POWER DISSIPATION vs. AMBIENT TEMPERATURE**

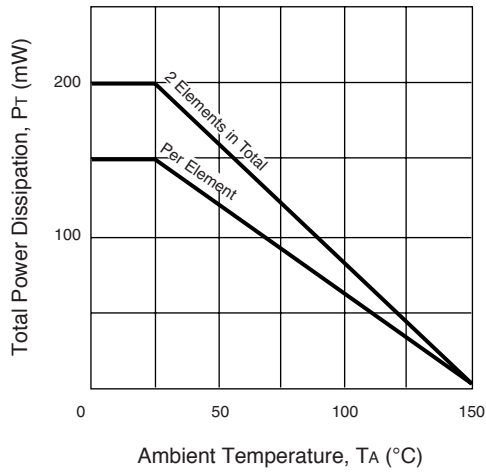

**COLLECTOR CURRENT vs. BASE TO EMITTER VOLTAGE**

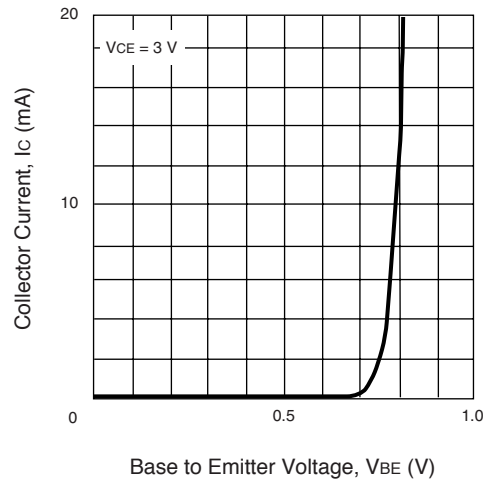

**COLLECTOR CURRENT vs. COLLECTOR TO EMITTER VOLTAGE**

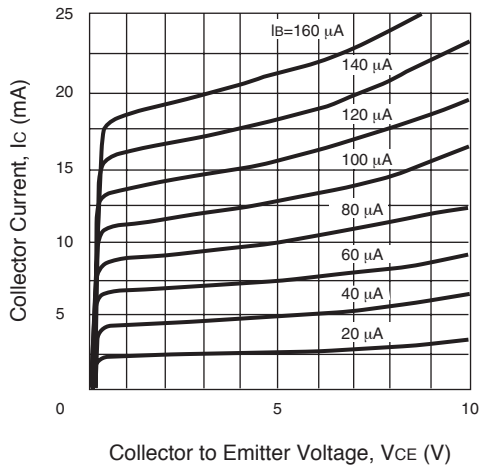

**DC CURRENT GAIN vs. COLLECTOR CURRENT**

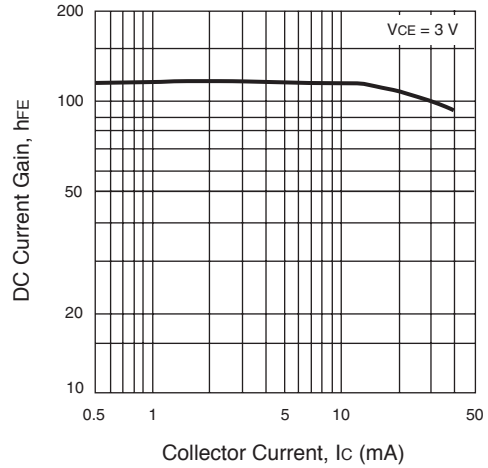

**TYPICAL PERFORMANCE CURVES** ( $T_A = 25^\circ\text{C}$ )

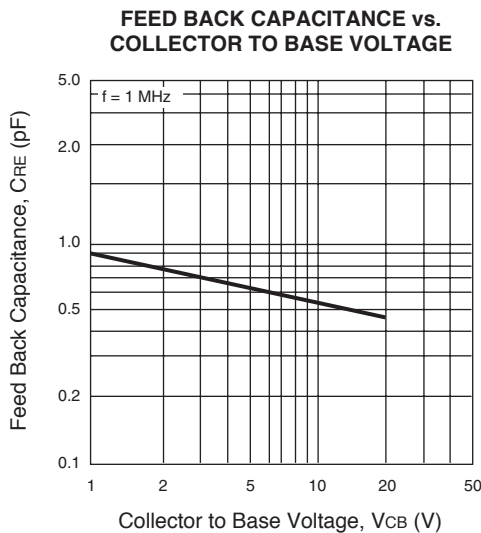
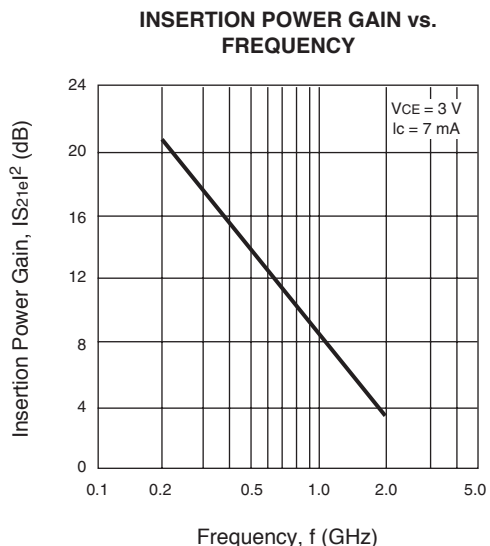
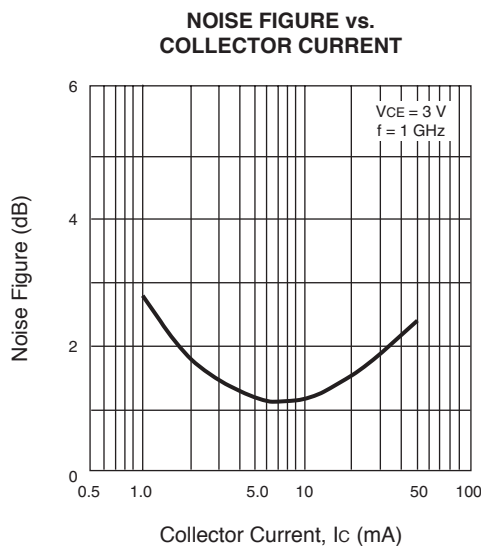
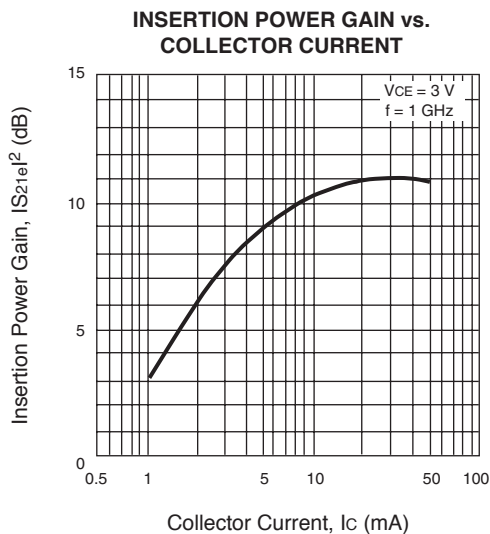
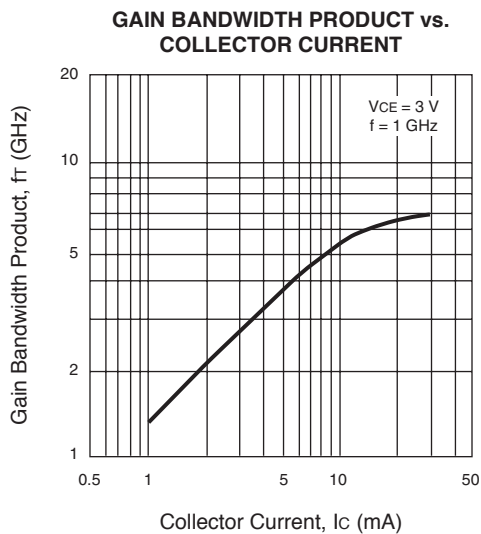

# UPA801T

## TYPICAL SCATTERING PARAMETERS (T<sub>A</sub> = 25°C)

### UPA801T

V<sub>CE</sub> = 3 V, I<sub>C</sub> = 1 mA, Z<sub>0</sub> = 50 Ω

FREQUENCY (GHz)	S <sub>11</sub>		S <sub>21</sub>		S <sub>12</sub>		S <sub>22</sub>	
	MAG	ANG	MAG	ANG	MAG	ANG	MAG	ANG
0.10	.967	-22.9	1.935	159.9	.045	74.0	.978	-9.2
0.20	.930	-45.8	1.968	143.1	.083	60.1	.931	-17.4
0.30	.884	-67.1	1.938	129.1	.108	48.9	.870	-23.2
0.40	.842	-86.9	1.827	117.2	.125	39.4	.822	-28.0
0.50	.801	-103.1	1.748	106.7	.134	32.6	.779	-31.9
0.60	.771	-117.0	1.576	97.4	.137	27.1	.749	-35.3
0.70	.742	-130.0	1.498	89.2	.137	22.9	.722	-38.4
0.80	.722	-141.2	1.403	81.9	.134	20.0	.702	-41.3
0.90	.706	-151.1	1.326	75.6	.129	18.5	.690	-44.4
1.00	.696	-159.9	1.242	69.6	.124	17.8	.680	-47.4
1.10	.689	-167.7	1.169	64.5	.118	18.1	.671	-50.4
1.20	.685	-174.9	1.102	59.6	.112	19.8	.666	-53.6
1.30	.681	178.7	1.030	55.3	.106	23.5	.660	-56.9
1.40	.681	172.6	.979	50.9	.103	28.0	.658	-60.4
1.50	.683	166.8	.925	47.2	.100	33.6	.654	-64.0
1.60	.684	161.4	.884	43.6	.102	40.4	.651	-67.6
1.70	.684	156.1	.842	40.4	.107	47.5	.651	-71.5
1.80	.686	151.4	.804	37.3	.115	53.5	.649	-75.1
1.90	.689	146.6	.773	34.6	.127	57.9	.646	-79.2
2.00	.690	142.1	.738	32.3	.141	62.1	.646	-83.0

V<sub>CE</sub> = 3 V, I<sub>C</sub> = 3 mA, Z<sub>0</sub> = 50 Ω

FREQUENCY (GHz)	S <sub>11</sub>		S <sub>21</sub>		S <sub>12</sub>		S <sub>22</sub>	
	MAG	ANG	MAG	ANG	MAG	ANG	MAG	ANG
0.10	.899	-30.5	5.578	153.7	.042	69.0	.923	-17.3
0.20	.808	-60.0	5.327	134.4	.069	54.5	.793	-29.2
0.30	.723	-86.7	4.877	119.6	.084	46.0	.679	-36.4
0.40	.660	-106.2	4.341	108.1	.093	41.1	.604	-39.5
0.50	.610	-125.9	3.883	98.5	.098	38.8	.550	-42.0
0.60	.583	-138.6	3.388	90.9	.102	37.4	.613	-44.2
0.70	.560	-150.0	3.046	84.3	.106	37.8	.487	-45.9
0.80	.547	-159.4	2.741	78.5	.108	38.1	.468	-47.9
0.90	.538	-167.4	2.498	73.4	.112	39.5	.455	-49.9
1.00	.535	-174.4	2.287	68.9	.116	41.0	.444	-52.3
1.10	.534	179.3	2.111	64.6	.120	43.0	.435	-54.7
1.20	.533	173.4	1.965	60.2	.125	45.1	.429	57.2
1.30	.533	168.3	1.830	56.3	.131	46.7	.424	-59.9
1.40	.534	163.2	1.721	52.7	.139	48.3	.422	-62.8
1.50	.538	158.7	1.620	49.2	.146	49.8	.417	-65.7
1.60	.542	154.3	1.544	45.7	.155	51.3	.414	-68.8
1.70	.545	150.0	1.464	42.7	.164	52.4	.415	-72.0
1.80	.548	146.1	1.396	39.5	.174	53.0	.412	-75.3
1.90	.552	142.0	1.336	36.6	.187	53.7	.411	-78.8
2.00	.556	138.3	1.280	33.6	.199	54.1	.411	-82.3

## TYPICAL SCATTERING PARAMETERS (T<sub>A</sub> = 25°C)

V<sub>CE</sub> = 3 V, I<sub>C</sub> = 5 mA, Z<sub>0</sub> = 50 Ω

FREQUENCY (GHz)	S <sub>11</sub>		S <sub>21</sub>		S <sub>12</sub>		S <sub>22</sub>	
	MAG	ANG	MAG	ANG	MAG	ANG	MAG	ANG
0.10	.819	-38.9	8.934	148.0	.038	65.8	.868	-23.6
0.20	.701	-73.4	8.007	127.6	.060	53.1	.687	-36.7
0.30	.608	-102.3	6.898	112.6	.072	47.6	.560	-42.4
0.40	.549	-123.6	5.819	101.8	.079	45.2	.483	-45.4
0.50	.511	-139.6	4.970	93.5	.086	45.7	.434	-47.2
0.60	.494	-151.0	4.255	86.9	.093	46.5	.402	-48.6
0.70	.481	-160.8	3.750	81.4	.099	47.2	.379	-49.9
0.80	.475	-168.6	3.328	76.3	.107	48.9	.361	-51.5
0.90	.472	-175.7	3.004	72.0	.113	49.7	.350	-53.4
1.00	.471	178.2	2.734	67.7	.122	50.9	.340	-55.4
1.10	.473	172.8	2.522	64.0	.130	51.6	.332	-57.3
1.20	.474	167.6	2.355	60.2	.139	52.3	.328	59.7
1.30	.474	162.9	2.176	56.7	.148	53.1	.322	-62.3
1.40	.477	158.4	2.038	53.2	.158	53.3	.319	-65.2
1.50	.481	154.4	1.921	49.8	.168	53.7	.315	-68.2
1.60	.484	150.3	1.818	46.7	.177	53.3	.313	-70.9
1.70	.489	146.5	1.726	43.9	.190	53.3	.312	-73.9
1.80	.490	142.9	1.647	40.6	.200	53.0	.312	-77.2
1.90	.495	139.3	1.578	37.6	.212	52.7	.309	-80.8
2.00	.501	136.0	1.505	35.0	.223	52.0	.309	-84.0

V<sub>CE</sub> = 3 V, I<sub>C</sub> = 7 mA, Z<sub>0</sub> = 50 Ω

FREQUENCY (GHz)	S <sub>11</sub>		S <sub>21</sub>		S <sub>12</sub>		S <sub>22</sub>	
	MAG	ANG	MAG	ANG	MAG	ANG	MAG	ANG
0.10	.750	-45.7	11.858	144.0	.035	63.3	.816	-28.5
0.20	.618	-84.9	10.093	122.3	.053	53.2	.609	-41.8
0.30	.528	-114.5	8.219	107.7	.054	50.6	.481	-46.7
0.40	.483	-134.3	6.684	97.9	.073	50.6	.411	-49.1
0.50	.459	-148.5	5.565	90.5	.081	50.7	.365	-50.5
0.60	.447	-158.8	4.737	84.6	.089	52.3	.337	-51.5
0.70	.441	-167.4	4.134	79.7	.098	53.5	.337	-51.5
0.80	.439	-174.4	3.653	75.2	.107	54.2	.300	-54.2
0.90	.437	179.2	3.283	71.1	.117	54.9	.290	-55.9
1.00	.437	173.7	2.978	67.2	.126	55.6	.281	-57.9
1.10	.440	168.6	2.732	63.7	.136	55.8	.275	-59.8
1.20	.443	163.9	2.533	60.0	.147	55.3	.270	-52.3
1.30	.444	159.6	2.357	66.6	.158	55.4	.267	-64.7
1.40	.449	155.5	2.216	53.4	.169	55.3	.264	-67.5
1.50	.450	151.6	2.077	50.3	.180	54.7	.259	-70.5
1.60	.455	147.9	1.972	47.4	.192	64.5	.258	-73.3
1.70	.459	144.3	1.868	44.3	.202	53.9	.256	-76.3
1.80	.462	140.9	1.789	41.3	.214	53.0	.255	-79.6
1.90	.466	137.5	1.702	38.4	.226	52.3	.253	-83.0
2.00	.470	134.4	1.635	36.1	.238	51.5	.253	-86.4

## ORDERING INFORMATION

PART NUMBER	QUANTITY	PACKAGING
UPA801T-T1-A	3000	Tape & Reel

## NONLINEAR MODEL

## BJT NONLINEAR MODEL PARAMETERS (1)

Parameters	Q1, Q2	Parameters	Q1, Q2
IS	6e-16	MJC	0.55
BF	120	XCJC	0.3
NF	0.98	CJS	0
VAF	10	VJS	0.75
IKF	0.08	MJS	0
ISE	32e-16	FC	0.5
NE	1.93	TF	12e-12
BR	12	XTF	6
NR	0.991	VTF	10
VAR	3.9	ITF	0.2
IKR	0.17	PTF	0
ISC	0	TR	1e-9
NC	2	EG	1.11
RE	0.38	XTB	0
RB	4.16	XTI	3
RBM	3.6	KF	1.56e-18
IRB	1.96e-4	AF	1.49
RC	2		
CJE	2.8e-12		
VJE	1.3		
MJE	0.5		
CJC	1.1e-12		
VJC	0.7		

(1) Gummel-Poon Model

## Note:

This nonlinear model utilized the latest data available.  
See our Design Parameter Library at [www.cel.com](http://www.cel.com) for this data.

## UNITS

Parameter	Units
time	seconds
capacitance	farads
inductance	henries
resistance	ohms
voltage	volts
current	amps

## MODEL RANGE

Frequency: 0.1 to 3.0 GHz  
Bias: VCE = 1 V to 5 V, IC = 1 mA to 10 mA  
Date: 12/98



Subject: Compliance with EU Directives

CEL certifies, to its knowledge, that semiconductor and laser products detailed below are compliant with the requirements of European Union (EU) Directive 2002/95/EC Restriction on Use of Hazardous Substances in electrical and electronic equipment (RoHS) and the requirements of EU Directive 2003/11/EC Restriction on Penta and Octa BDE.

CEL Pb-free products have the same base part number with a suffix added. The suffix –A indicates that the device is Pb-free. The –AZ suffix is used to designate devices containing Pb which are exempted from the requirement of RoHS directive (\*). In all cases the devices have Pb-free terminals. All devices with these suffixes meet the requirements of the RoHS directive.

This status is based on CEL’s understanding of the EU Directives and knowledge of the materials that go into its products as of the date of disclosure of this information.

Restricted Substance per RoHS	Concentration Limit per RoHS (values are not yet fixed)	Concentration contained in CEL devices	
		-A	-AZ
Lead (Pb)	< 1000 PPM	Not Detected	(*)
Mercury	< 1000 PPM	Not Detected	
Cadmium	< 100 PPM	Not Detected	
Hexavalent Chromium	< 1000 PPM	Not Detected	
PBB	< 1000 PPM	Not Detected	
PBDE	< 1000 PPM	Not Detected	

If you should have any additional questions regarding our devices and compliance to environmental standards, please do not hesitate to contact your local representative.

Important Information and Disclaimer: Information provided by CEL on its website or in other communications concerning the substance content of its products represents knowledge and belief as of the date that it is provided. CEL bases its knowledge and belief on information provided by third parties and makes no representation or warranty as to the accuracy of such information. Efforts are underway to better integrate information from third parties. CEL has taken and continues to take reasonable steps to provide representative and accurate information but may not have conducted destructive testing or chemical analysis on incoming materials and chemicals. CEL and CEL suppliers consider certain information to be proprietary, and thus CAS numbers and other limited information may not be available for release.

In no event shall CEL’s liability arising out of such information exceed the total purchase price of the CEL part(s) at issue sold by CEL to customer on an annual basis.

See CEL Terms and Conditions for additional clarification of warranties and liability.

