

1.0A SURFACE MOUNT ULTRA FAST RECTIFIER

Features

- Glass Passivated Die Construction
- Ideally Suited for Automatic Assembly
- Low Forward Voltage Drop, High Efficiency
- Surge Overload Rating to 30A Peak
- Low Power Loss
- Ultra-Fast Recovery Time
- Plastic Case Material has UL Flammability Classification Rating 94V-O

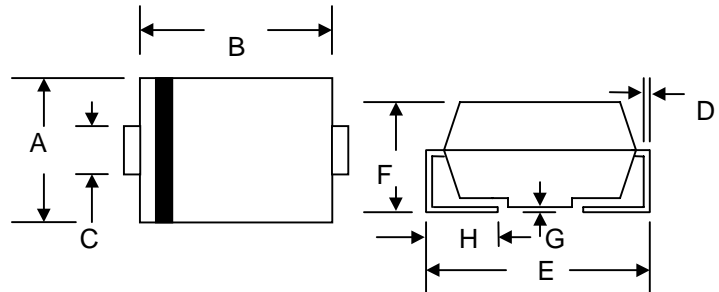

Mechanical Data

- Case: Molded Plastic
- Terminals: Solder Plated, Solderable per MIL-STD-750, Method 2026
- Polarity: Cathode Band or Cathode Notch
- Marking: Type Number
- Weight: 0.093 grams (approx.)

SMB/DO-214AA		
Dim	Min	Max
A	3.30	3.94
B	4.06	4.70
C	1.91	2.11
D	0.152	0.305
E	5.08	5.59
F	2.13	2.44
G	0.051	0.203
H	0.76	1.27
All Dimensions in mm		

Maximum Ratings and Electrical Characteristics @ $T_A=25^\circ\text{C}$ unless otherwise specified

Characteristic	Symbol	UF1A	UF1B	UF1D	UF1G	UF1J	UF1K	Unit
Peak Repetitive Reverse Voltage	V_{RRM}							
Working Peak Reverse Voltage	V_{RWM}	50	100	200	400	600	800	V
DC Blocking Voltage	V_R							
RMS Reverse Voltage	$V_{R(RMS)}$	35	70	140	280	420	560	V
Average Rectified Output Current @ $T_L = 100^\circ\text{C}$	I_O	1.0						A
Non-Repetitive Peak Forward Surge Current 8.3ms Single half sine-wave superimposed on rated load (JEDEC Method) @ $T_A = 55^\circ\text{C}$	I_{FSM}	30						A
Forward Voltage @ $I_F = 1.0\text{A}$	V_{FM}	1.0		1.4		1.7		V
Peak Reverse Current @ $T_A = 25^\circ\text{C}$ At Rated DC Blocking Voltage @ $T_A = 100^\circ\text{C}$	I_{RM}	10 500						μA
Reverse Recovery Time (Note 1)	t_{rr}	50				100		nS
Typical Junction Capacitance (Note 2)	C_j	15						pF
Typical Thermal Resistance (Note 3)	$R_{\theta JL}$	30						K/W
Operating and Storage Temperature Range	T_j, T_{STG}	-50 to +150						$^\circ\text{C}$

Note: 1. Measured with $I_F = 0.5\text{A}$, $I_R = 1.0\text{A}$, $I_{rr} = 0.25\text{A}$,
 2. Measured at 1.0 MHz and applied reverse voltage of 4.0 V DC.
 3. Mounted on P.C. Board with 8.0mm² land area.

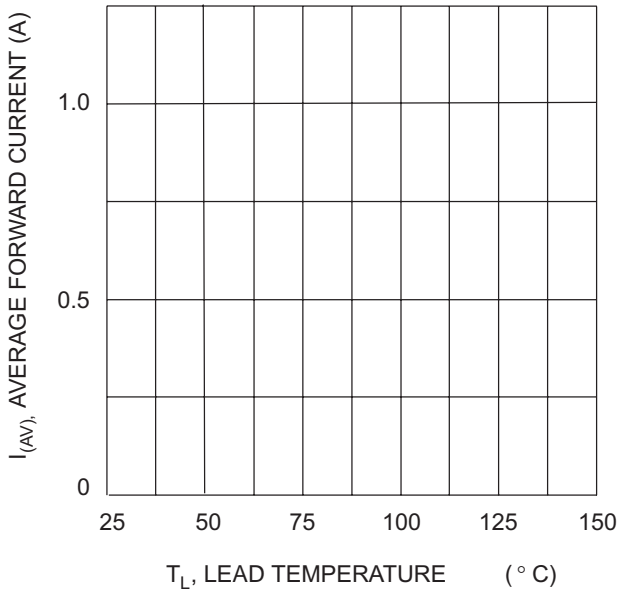

Fig. 1 Forward Current Derating Curve

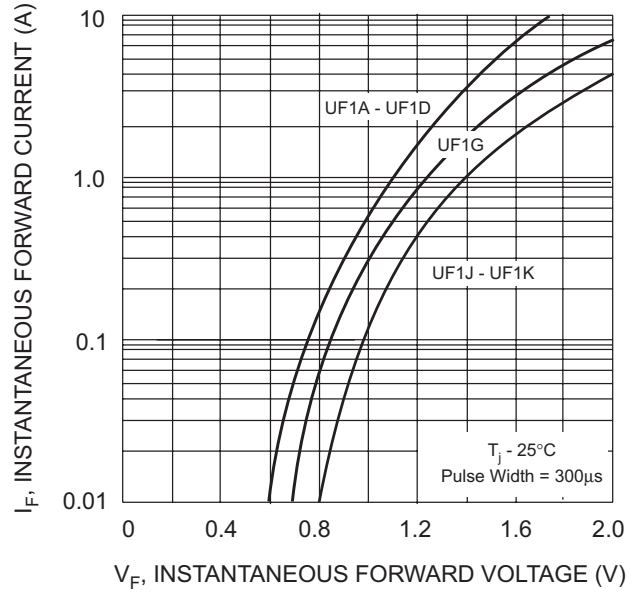

Fig. 2 Typical Forward Characteristics

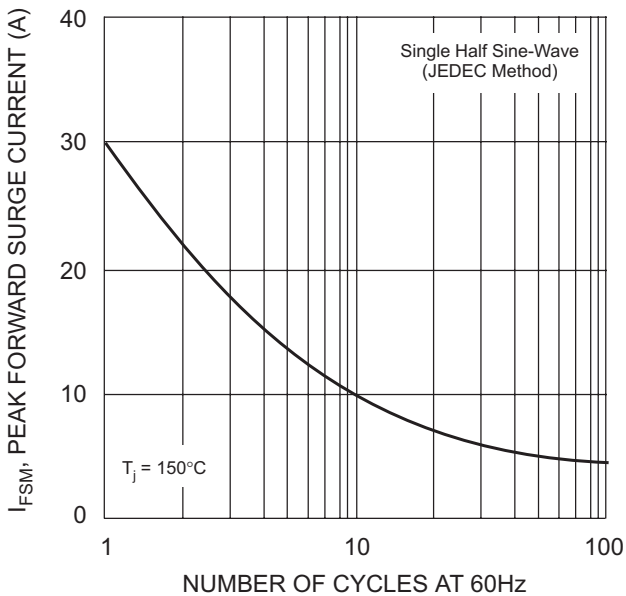

Fig. 3 Forward Surge Current Derating Curve

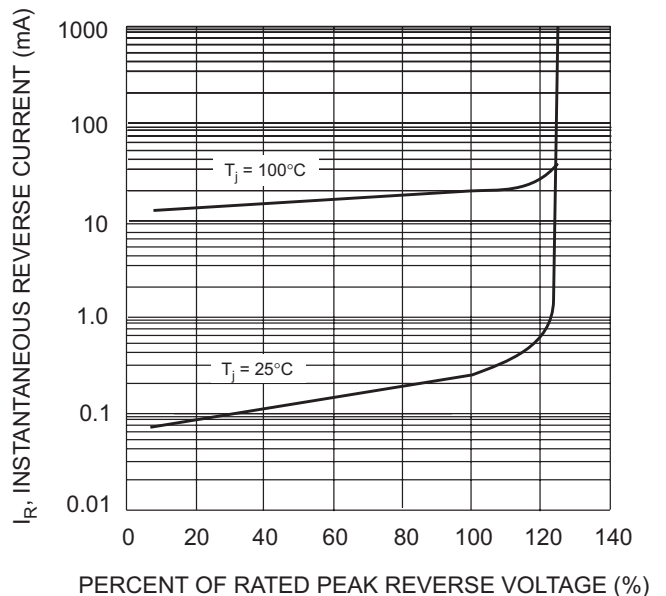
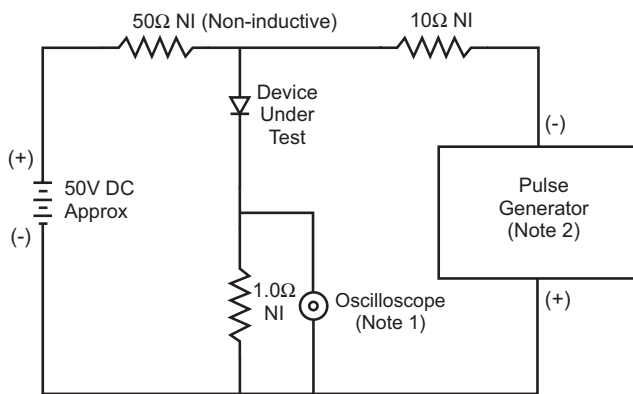

Fig. 4 Typical Reverse Characteristics



- Notes:
1. Rise Time = 7.0ns max. Input Impedance = 1.0MΩ, 22pF.
 2. Rise Time = 10ns max. Input Impedance = 50Ω.

Fig. 5 Reverse Recovery Time Characteristic and Test Circuit

ORDERING INFORMATION

Product No.♦	Package Type	Shipping Quantity
UF1A-T1	SMB	500/Tape & Reel
UF1A-T3	SMB	3000/Tape & Reel
UF1B-T1	SMB	500/Tape & Reel
UF1B-T3	SMB	3000/Tape & Reel
UF1D-T1	SMB	500/Tape & Reel
UF1D-T3	SMB	3000/Tape & Reel
UF1G-T1	SMB	500/Tape & Reel
UF1G-T3	SMB	3000/Tape & Reel
UF1J-T1	SMB	500/Tape & Reel
UF1J-T3	SMB	3000/Tape & Reel
UF1K-T1	SMB	500/Tape & Reel
UF1K-T3	SMB	3000/Tape & Reel

Products listed in **bold** are WTE **Preferred** devices.

♦T1 suffix refers to a 7" reel. T3 suffix refers to a 13" reel.

Shipping quantity given is for minimum packing quantity only. For minimum order quantity, please consult the Sales Department.

RECOMMENDED FOOTPRINT

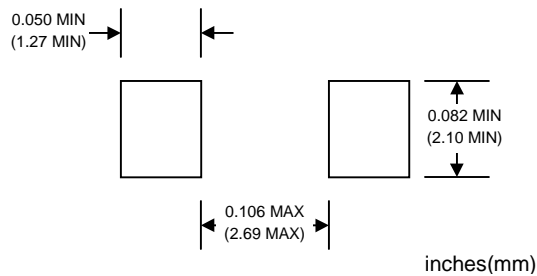

Won-Top Electronics Co., Ltd (WTE) has checked all information carefully and believes it to be correct and accurate. However, WTE cannot assume any responsibility for inaccuracies. Furthermore, this information does not give the purchaser of semiconductor devices any license under patent rights to manufacturer. WTE reserves the right to change any or all information herein without further notice.

WARNING: DO NOT USE IN LIFE SUPPORT EQUIPMENT. WTE power semiconductor products are not authorized for use as critical components in life support devices or systems without the express written approval.

Won-Top Electronics Co., Ltd.

No. 44 Yu Kang North 3rd Road, Chine Chen Dist., Kaohsiung, Taiwan

Phone: 886-7-822-5408 or 886-7-822-5410

Fax: 886-7-822-5417

Email: sales@wontop.com

Internet: <http://www.wontop.com>

We power your everyday.