

Features

- One 64 x 8 (512 bit) Configuration Zone
- Three 64 x 8 (512 bit) User Zones
- Programmable Chip Select
- Low-voltage Operation: 2.7V to 5.5V
- Two-wire Serial Interface
- 8-byte Page Write Mode
- Self-timed Write Cycle (10 ms max)
- ISO 7816-3 Synchronous Protocol
- Answer-to-Reset Register
- High-security Memory Including Anti-wire Tapping
 - 64-bit Authentication Protocol*
 - Secure Checksum
 - Configurable Authentication Attempts Counter
 - Two Sets of Two 24-bit Passwords
 - Specific Passwords for Read and Write
 - Four Password Attempts Counters
 - Selectable Access Rights by Zone
- ISO Compliant Packaging
- High Reliability
 - Endurance: 100,000 Cycles
 - Data Retention: 100 Years
 - ESD Protection: 4,000V min
- Low-Power CMOS

Description

The AT88SC153 provides 2,048 bits of serial EEPROM memory organized as one configuration zone of 64 bytes and three user zones of 64 bytes each. This device is optimized as a “secure memory” for multi-application smart card markets, secure identification for electronic data transfer or for components in a system without the requirement of an internal microprocessor.

The embedded authentication protocol allows the memory and the host to authenticate each other. When this device is used with a host which incorporates a microcontroller, e.g., AT89C51, AT89C2051, AT90S1200, the system provides an “anti-wire tapping” configuration. The device and the host exchange “challenges” issued from a random generator and verify their values through a specific cryptographic function included in each part. When both agree on the same result, the access to the memory is permitted.

Security Methodology

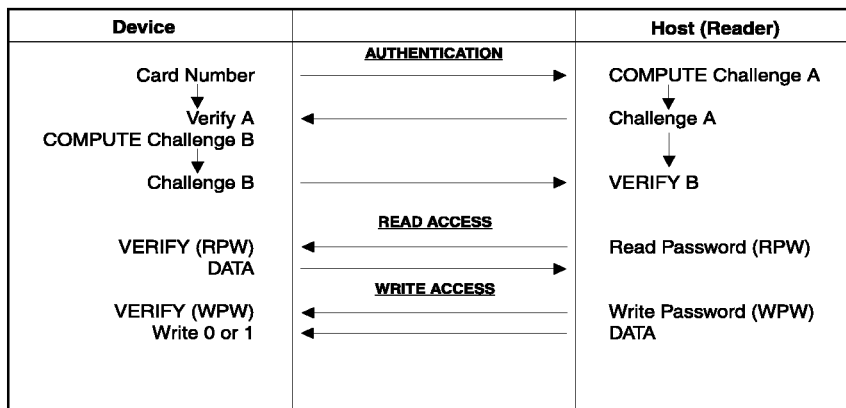

**3 x 64 x 8
Secure Memory
with
Authentication**

AT88SC153

Rev. 1016B-11/99

*Under exclusive patent license from ELVA



Memory Access

Depending on the device configuration, the host might carry out the authentication protocol, and/or present different passwords for each operation: read or write. Each user zone may be configured for free access for read and write, or for password restricted access. To insure security between the different user zones (multi-application card), each zone can use a different set of passwords. A specific

attempts counter for each password and for the authentication provides protection against “systematic attacks”. When the memory is unlocked, the two-wire serial protocol is effective, using SDA and SCL. The memory includes a specific register providing a 32-bit data stream conforming to the ISO 7816-3 synchronous Answer-to-Reset.

Block Diagram

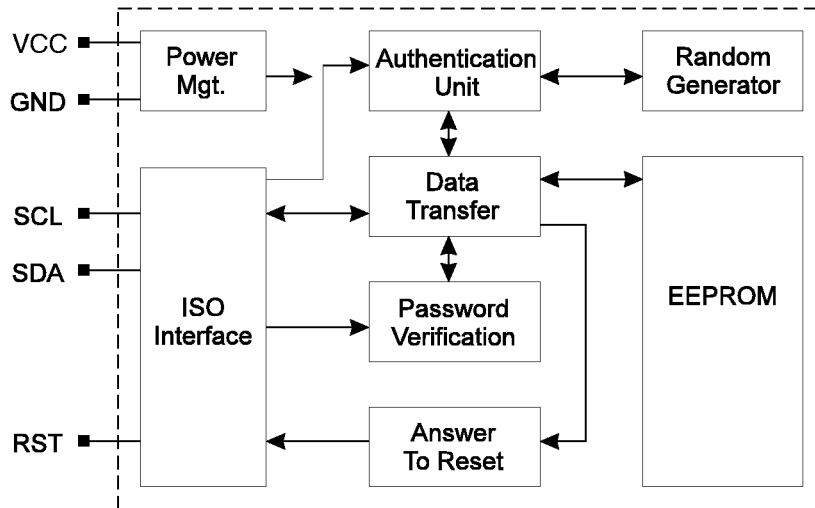

Pin Descriptions

Supply Voltage (VCC)

The VCC input is a 2.7V to 5.5V positive voltage supplied by the host.

Serial Clock (SCL)

The SCL input is used to positive edge clock data into the device and negative edge clock data out of the device.

Serial Data (SDA)

The SDA pin is bi-directional for serial data transfer. This pin is open-drain driven, and may be wire-ORed with any number of other open drain or open collector devices. An external pull up resistor should be connected between SDA and VCC. The value of this resistor and the system

capacitance loading the SDA bus will determine the rise time of SDA. This rise time will determine the maximum frequency during Read operations. Low value pull-up resistors will allow higher frequency operations while drawing higher average power supply current.

Reset (RST)

When the RST input is pulsed high, the device will output the data programmed into the 32-bit answer-to-reset register. All password and authentication access will be reset. Following a reset, device authentication and password verification sequences must be presented to re-establish user access.

Memory Mapping

The 2,048 bits of the memory are divided in four zones of 64 bytes each:

Zone	\$0	\$1	\$2	\$3	\$4	\$5	\$6	\$7	@
User 0 zz = 00									\$00
	64 bytes								-
									-
									\$38
User 1 zz = 01									\$00
	64 bytes								-
									-
									\$38
User 2 zz = 10									\$00
	64 bytes								-
									-
									\$38
Configuration zz = 11									\$00
	64 bytes								-
									-
									\$38

The last 64 bytes of the memory is a configuration zone with specific system data, access rights and read/write commands; it is divided in four subzones⁽¹⁾.

Configuration	\$0	\$1	\$2	\$3	\$4	\$5	\$6	\$7	@	
Fabrication	Answer-to-Reset				Lot History Code				\$00	
	Fab Code		CMC		AR0	AR1	AR2	MTZ	\$08	
Identification	Issuer Code								\$10	
	DCR	Identification Number (Nc)								\$18
	AAC ⁽²⁾	Cryptogram (Ci)								\$20
Secret	Secret Seed (Gc)								\$28	
Passwords	PAC	Write 0			PAC	Read 0			\$30	
	PAC	Secure Code/Write 1			PAC	Read 1			\$38	

- Notes:
1. CMC: Card Manufacturer Code.
AR0-2: Access Register for User Zone 0 to 2.
MTZ: Memory Test Zone.
DCR: Device Configuration Register.
AAC: Authentication Attempts Counter.
PAC: Password Attempts Counter.
zz: Zone number

2. Address \$20 also serves as the virtual address of the Checksum Authentication Register (CAR) during checksum mode.



Fuses

- FAB, CMA and PER are nonvolatile fuses blown at the end of each card life step. Once blown, these EEPROM fuses can not be reset.
- The FAB fuse is blown by Atmel prior to shipping wafers to the card manufacturer.
- The CMA fuse is blown by the card manufacturer prior to shipping cards to the issuer.
- The PER fuse is blown by the issuer prior to shipping cards to the end user.

The device responds to a Read Fuse command with “fuse byte”.

Bit 7	Bit 6	Bit 5	Bit 4	Bit 3	Bit 2	Bit 1	Bit 0
0	0	0	0	0	PER	CMA	FAB

When the fuses are all 1's, read and write are allowed in the entire memory. Before blowing the FAB fuse, Atmel writes the entire memory to “1”, and programs the fabrication subzone (except CMC and AR) and the secure code.

Zone	Access	FAB = 0	CMA = 0	PER = 0
Fabrication (Except CMC, MTZ and AR)	Read	Free	Free	Free
	Write	Forbidden	Forbidden	Forbidden
Card Manufacturer Code	Read	Free	Free	Free
	Write	Secure Code	Forbidden	Forbidden
Access Registers	Read	Free	Free	Free
	Write	Secure Code	Secure Code	Forbidden
Memory Test Zone	Read	Free	Free	Free
	Write	Free	Free	Free
Identification	Read	Free	Free	Free
	Write	Secure Code	Secure Code	Forbidden
Secret	Read	Secure Code	Secure Code	Forbidden
	Write	Secure Code	Secure Code	Forbidden
Passwords	Read	Secure Code	Secure Code	Write PW
	Write	Secure Code	Secure Code	Write PW
PAC	Read	Free	Free	Free
	Write	Secure Code	Secure Code	Write PW
User Zones	Read	AR	AR	AR
	Write	AR	AR	AR

Note: CMC: Card Manufacturer Code.
 AR: Access Rights as defined by the Access Registers.
 PW: Password.

Configuration Zone

Answer-to-Reset

32-bit register defined by Atmel.

Lot History Code

32-bit register defined by Atmel.

Fab Code

16-bit register defined by Atmel.

Card Manufacturer Code

16-bit register defined by the card manufacturer.

Issuer Code

64-bit register defined by the card issuer.

Access Registers

Three 8-bit access registers defined by the issuer, one for each user zone. (Active low)

Bit 7	Bit 6	Bit 5	Bit 4	Bit 3	Bit 2	Bit 1	Bit 0
WPE	RPE	ATE	AOW	PWS	WLM	MDF	PGO

WPE - Write Password Enable

If enabled (WPE = "0"), the user is required to verify the Write Password to allow write operations in the user zone. If disabled (WPE = "1"), all write operations are allowed within the zone. Verification of the Write password also allows the Read and Write passwords to be changed.

RPE - Read Password Enable

If enabled (RPE = "0"), the user is required to verify either the Read Password or Write Password to allow read operations in the user zone. Read operations initiated without a verified password will return \$00 (or the status of the fuse bits, if either CMA or PER are still intact). Verification of the Write password will always allow read access to the zone. RPE = "0" and WPE = "1" is allowed, but is not recommended.

ATE - Authentication Enable

If enabled (ATE = "0"), a valid Authentication sequence is required for both Read and Write and must be completed before access is allowed to the user zone. If disabled (ATE = "1"), authentication is not required for access.

AOW - Authentication Only for Write

If enabled (AOW = "0"), a valid Authentication sequence must be completed before write access is allowed to the

user zone. Read access to this zone is allowed without authentication. This bit is ignored if ATE is enabled.

PWS - Password Select

This bit defines which of the two password sets must be presented to allow access to the user zone. Each access register may point to a unique password set, or access registers for multiple zones may point to the same password set. In this case, verification of a single password will open several zones, combining the zones into a single larger zone.

WLM - Write Lock Mode

If enabled (WLM = "0"), the eight bits of the first byte of each user zone page will define the locked/unlocked status for each byte in the page. Write access is forbidden to a byte if its associated bit in byte 0 is set to "0". Bit 7 controls byte 7, bit 6 controls byte 6, etc.

MDF - Modify Forbidden

If enabled (MDF = "0"), no write access is allowed in the zone at any time. The user zone must be written before the PER is blown.

PGO - Program Only

If enabled (PGO = "0"), data within the zone may be changed from "1" to "0", but never from "0" to "1".

Identification Number (Nc)

An identification number with up to 56-bits is defined by the issuer and should be unique for each device.

Cryptogram (Ci)

The 56-bit cryptogram is generated by the internal random generator and modified after each successful verification of the cryptogram by the chip, on host request. The initial value, defined by the issuer, is diversified as a function of the identification number. The 64 bits used in the Authentication protocol consist of the 56-bit cryptogram and the 8-bit Authentication Attempts counter. Note that any change in the AAC status will change Ci for the next authentication attempt.

Secret Seed (Gc)

The 64-bit secret seed, defined by the issuer, is diversified as a function of the identification number.

Memory Test Zone

8-bit free access zone for memory and protocol test.

Password Set

Two sets of two 24-bit passwords for read and write operations, defined by the issuer. The Write Password allows modification of the Read and Write passwords of the same set. By default, Password 1 is selected for all user zones.

Secure Code

24-bit password, defined by Atmel, is different for each card manufacturer. The Write Password 1 is used as the Secure Code until the personalization is over (PER = 0).

Attempts Counters

Four 8-bit attempts counters, one for each password (PAC), and one other 8-bit Attempts Counter for the authentication protocol (AAC). The attempts counters limit the number of consecutive incorrect code presentations allowed (currently 4).

Device Configuration Register

This 8-bit register allows the issuer to select the following device configuration options (active-low).

Bit 7	Bit 6	Bit 5	Bit 4	Bit 3	Bit 2	Bit 1	Bit 0
SME	UCR	UAT	ETA	CS3	CS2	CS1	CS0

CS0 - CS3 - Programmable Chip Select

The four most significant bits (b4 - b7) of every command comprise the Chip Select Address. All AT88SC153 devices will respond to the default Chip Select Address of \$B (1011). Each device will also respond to a second Chip Select Address programmed into CS0 - CS3 of the Device Configuration Register. By programming each device to a unique Chip Select Address, it is possible to connect up to 15 devices on the same Serial Data bus. Write EEPROM and Verify Password commands can be used globally to all devices sharing the bus by using the default Chip Select Address \$B.

ETA - Eight Trials Allowed

If enabled (ETA = "0"), extends the trials limit to 8 incorrect presentations allowed (passwords or authentication). If disabled (ETA = "1"), the Password Attempts Counter (PAC) and Authentication Attempts Counter (AAC) will allow only four incorrect attempts.

UAT - Unlimited Authentication Trials

If enabled (UAT = "0"), the Authentication Attempts Counter (AAC) is disabled, allowing an unlimited number of authentication attempts. The Password Attempts Counters (PAC) are not affected by the UAT bit.

UCR - Unlimited Checksum Reads

If enabled (UCR = "0"), the device will allow an unlimited number of checksums without requiring a new Authentication.

SME - Supervisor Mode Enable

If enabled (SME = "0"), verification of the Write 1 Password will allow the user to write and read the entire Passwords zone (including the PACs).

Checksum Authentication Register

After a valid authentication has been completed, the internal pseudo-random generator (PRG) will compute a secure checksum after one write command or several consecutive write commands. This checksum certifies that the data sent by the host during the write commands were received and therefore written in the memory. For every Write command, the device clocks the data bytes into the PRG and its output is the Checksum Authentication Register (CAR), which is a function of Ci, Gc, Q and the data bytes written.

After a valid authentication, any write command will enable the checksum mode, and cause AAC to become the virtual location of the eight byte CAR. When all data have been transmitted, the host may perform a "Read CAR" command, by sending a Read command with the AAC address (\$20). The first eight bytes transmitted by the device form the secure checksum.

The checksum mode allows only a single "Read CAR" operation for each valid Authentication. The checksum mode is disabled at the end of the "Read CAR" command, whatever the number of bytes transmitted, or by a read command with any other address. The checksum mode can only be enabled once for a given authentication.

Note: During the "Read CAR" command, the internal address counter is incremented just as in a normal read command. Once eight bytes have been transmitted, the checksum mode is automatically disabled, and if the host continues to request data, the device responds as to a normal Read command, from the address \$28.

User Zones

Three zones are dedicated to the user data. The access rights of each zone are programmable separately via the access registers. If several zones share the same password set, this set will be entered only once (after the part is powered up), so several zones might be combined in one larger zone.

Security Operations

Write Lock

If a user zone is configured in the write lock mode (Access Register bit 2), the lowest address byte of a page constitutes a write access byte for the bytes of that page.

\$0 - WLB	\$1	\$2	\$3	\$4	\$5	\$6	\$7	@
1101100 1	x x Lock	x x Lock	x x	x x	x x Lock	x x	x x	\$00

Example: the write lock byte at \$00 controls the bytes from \$00 to \$07.

The Write Lock byte (WLB) can also lock itself by writing its least significant (right most) bit to "0". The Write Lock byte can only be programmed, that is, bits written to "0" cannot return to "1".

In the write lock configuration, only one byte of the page can be written at a time. Even if several bytes are received, only the first byte will be taken into account by the device.

Password Verification

Compare the operation password presented with the stored one, and write a new bit in the corresponding attempts counter for each wrong attempt. A valid attempt erases the attempts counter, and allows the operation to be carried out as long as the chip is powered.

The current password is memorized and active until power is turned off, unless a new password is presented or RST becomes active. Only one password is active at a time. The

AT88SC153 requires that the Verify Password command be transmitted twice in sequence to successfully verify a Write or Read password⁽¹⁾. The first Verify Password command can be considered an initialization command. It will write a new bit ("0") in the corresponding password attempts counter. The data bits in this initialization command are ignored. The second Verify password command will compare the 3-byte password data presented with the corresponding password value stored in memory. If the comparison is valid, the password attempts counter will be cleared. A successful password verification will allow authorized operations to be carried out as long as the chip is powered. The current password is memorized and active until power is turned off, a new password is presented or RST becomes active. Only one password is active at a time. If a new user zone is selected which points to a different password set, the new password must be verified and the old password becomes invalid.

Note: 1. This two-pass method of password verification was implemented in the AT88SC153 to protect the device from attacks on the password security system.

Authentication Protocol

The access to an user zone may be protected by an authentication protocol in addition to password dependent rights.

The authentication success is memorized and active, as long as the chip is powered, unless a new authentication is initialized or RST becomes active. If the new authentication request is not validated, the card has lost its previous authentication and it should be presented again. Only the last request is memorized.

The Authentication Verification protocol requires the host to perform an Initialize authentication command, followed by a verify authentication command.

Note: The password and authentication may be presented at any time and in any order. If the trials limit has been reached, *i.e.* the 8 bits of the attempts counter have been written, the password verification or authentication process will not be taken into account.



AT88SC153 Command Definitions and Protocols

The ISO compliant interface is based on the popular two-wire serial interface. Note that the MOST significant bit is transmitted first.

Command								Description
Chip Select				Instruction				
b7	b6	b5	b4	b3	b2	b1	b0	
CS3	CS2	CS1	CS0	z	z	0	0	Write EEPROM
CS3	CS2	CS1	CS0	z	z	0	1	Read EEPROM
CS3	CS2	CS1	CS0	r	p	1	1	Verify Password
CS3	CS2	CS1	CS0	0	0	1	0	Initialize Authentication
CS3	CS2	CS1	CS0	0	1	1	0	Verify Authentication
CS3	CS2	CS1	CS0	1	0	1	0	Write fuse
CS3	CS2	CS1	CS0	1	1	1	0	Read fuse

Read EEPROM

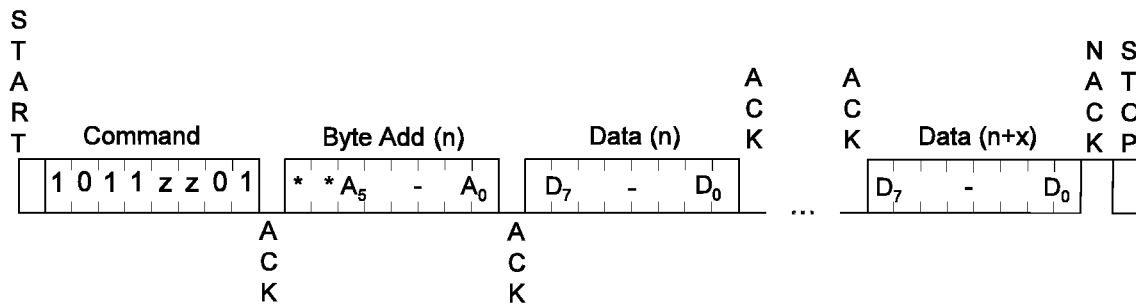

Note: *don't care bit
 zz: Zone number
 r : Read/Write password
 p : Password set

The data byte address is internally incremented following the transmission of each data byte. During a read operation the address "roll over" is from the last byte of the current zone, to the first byte of the same zone. If the host is not

allowed to read at the specified address, the device will transmit the corresponding data byte with all bits equal to "0".

Write EEPROM

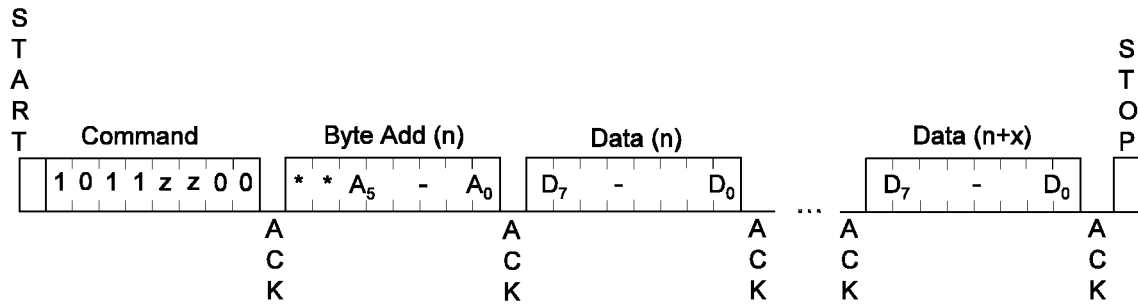

Note: *don't care bit
zz: Zone number

The data byte address lower three bits are internally incremented following the receipt of each data byte. The higher data byte address bits are not incremented, retaining the 8-byte write page address. Each data byte within a page must only be loaded once. Once a stop condition is issued to indicate the end of the host's write operation, the device initiates the internal nonvolatile write

cycle. An ACK polling sequence can be initiated immediately. After a write command, if the host is not allowed to write at some address locations, a nonvolatile write cycle will still be initiated, but the device will only modify data at the allowed addresses. When Write Lock Mode is enabled (WLM = "0"), the write cycle is initiated automatically after the first data byte has been transmitted.

Read Fuses

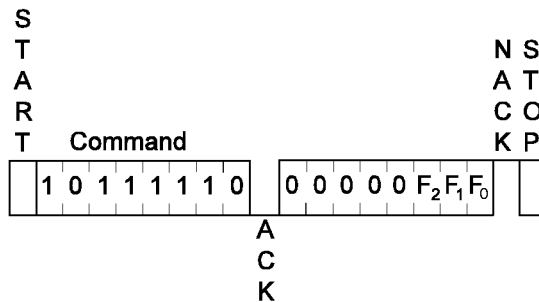

Note: F_x = 1 : fuse is not blown
F_x = 0 : fuse is blown

The read fuses operation is always allowed. The AT88SC153 will continuously transmit the fuse byte if the

host continues to transmit an ACK. The command is terminated when the host transmits a NACK and STOP bit.

Write Fuses

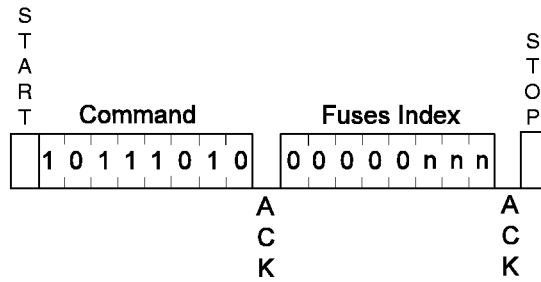

Note: nnn = 001 : Blow FAB
 nnn = 010 : Blow CMA
 nnn = 100 : Blow PER

The write fuses operation is only allowed under secure code control, no data byte is transmitted by the host. The fuses are blown sequentially: CMA is blown if FAB is equal to "0", and PER is blown if CMA is equal to "0". If the fuses are all 0's, the operation is canceled and the device waits for a new command.

Once a stop condition is issued to indicate the end of the host's write operation, the device initiates the internal nonvolatile write cycle. An ACK polling sequence can be initiated immediately.

Answer-to-Reset

If RST is high during SCL clock pulse, the reset operation occurs according to the ISO 7816-3 synchronous Answer-to-Reset. The 4 bytes of the Answer-to-Reset register are

transmitted LEAST significant bit first, on the 32 clock pulses provided on SCL.

The values programmed by Atmel are:

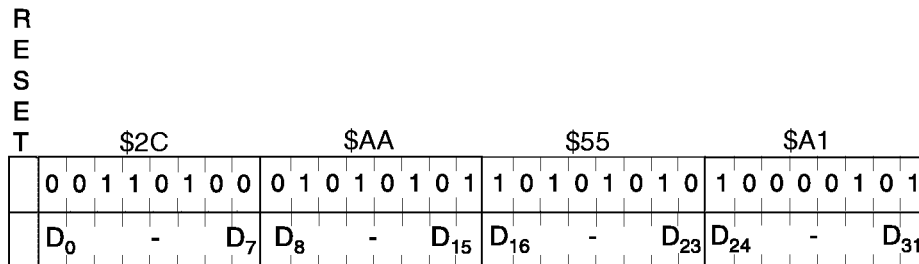

Verify Password

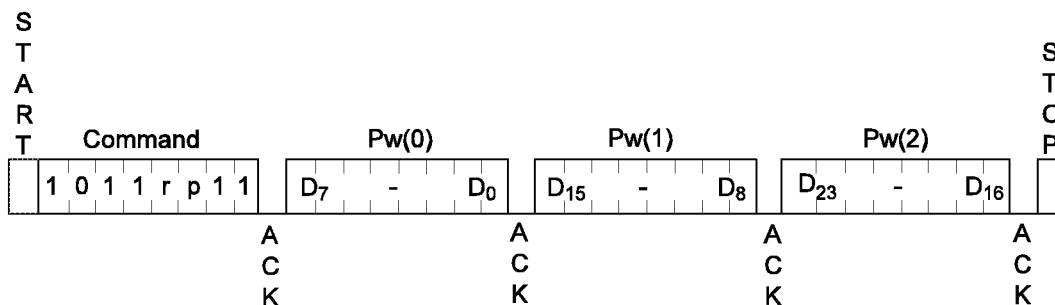

- Notes:
1. Pw: Password, 3 bytes.
 2. The two bits "rp" indicate the password to compare:
 - r = 0: Write password,
 - r = 1: Read password,
 - p: Password set number.
 - rp = 01 for the secure code.

This command must be transmitted twice in sequence to successfully verify a Write or Read password. The first Verify Password command can be considered an initialization command. It will write a new bit ("0") in the password attempts counter corresponding to the "r" and "p" bits. The data bits in this initialization command are ignored. The second Verify password command will compare the 3-byte password data presented with the corresponding password value stored in memory. If the comparison is valid, the password attempts counter will be

cleared. For both commands, once the command sequence is completed and a stop condition is issued, a nonvolatile write cycle is initiated to update the associated attempts counter. After the stop condition is issued, an ACK polling sequence with the specific command byte of \$BD will indicate the end of the write cycle, and will read the attempts counter in the configuration zone. The initialization command will result in a "0" bit in the PAC. The second Verify Password command will read \$FF in the PAC if the verification was successful.

Initialize Authentication

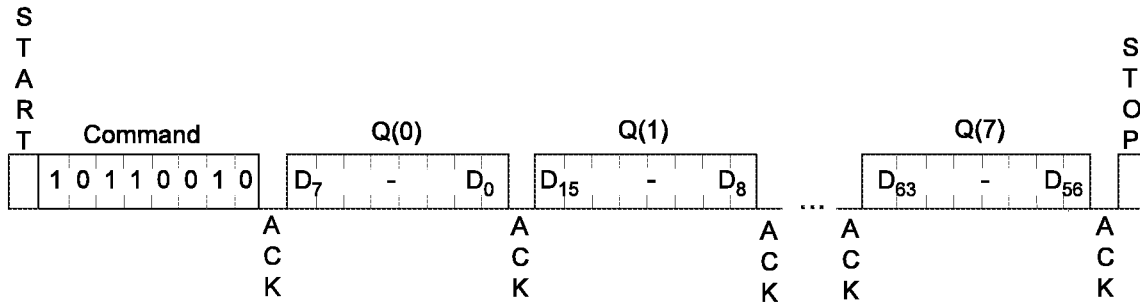

Note: Q: Host random number, 8 bytes.

The initialize authentication command sets up the random generator with the cryptogram (C_i), the secret seed (G_c) and the host random number (Q). Once the sequence is completed and a stop condition is issued, there is a nonvolatile write cycle to clear a new bit of the

authentication attempts counter. In order to complete the authentication protocol, the device requires the host to perform an ACK polling sequence with the specific command byte of \$B6, corresponding to the verify authentication command.

Verify Authentication

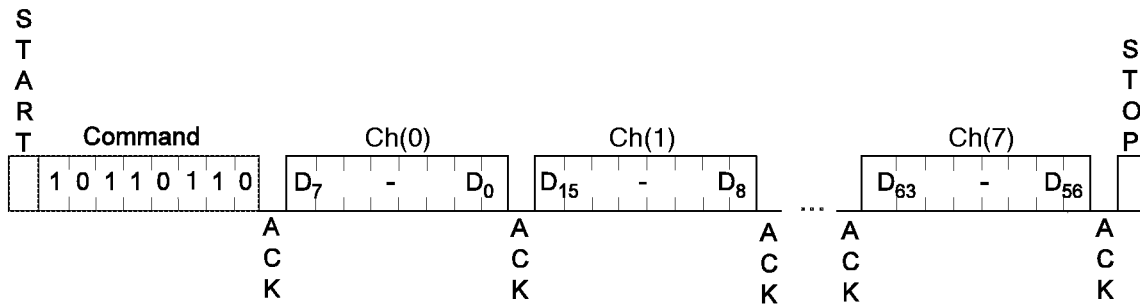

Note: Ch: Host challenge, 8 bytes.

If Ch is equal to C_{i+1} , then the device writes C_{i+2} in memory in place of C_i ; this must be preceded by the initialize authentication command. Once the sequence is completed and a stop condition is issued, there is a nonvolatile write cycle to update the associated attempts

counter. In order to know whether or not the authentication was correct, the device requires the host to perform an ACK polling sequence with the specific command byte of \$BD, to read the corresponding attempts counter in the configuration zone.

Pin Description

Name	Description	ISO Module Contact	Standard Package Pin
VCC	Supply Voltage	C1	8
GND	Ground	C5	1
SCL	Serial Clock Input	C3	6
SDA	Serial Data Input/Output	C7	3
RST	Reset Input	C2	7

Card Module Contact

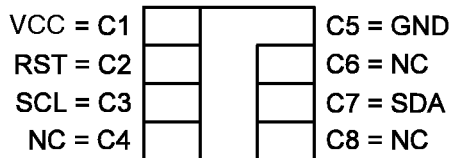

8-pin SOIC, PDIP, EIAJ or LAP

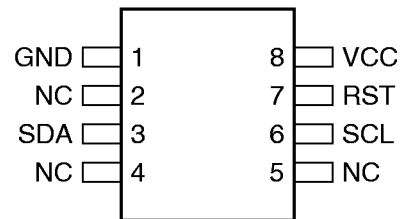

Device Operation

CLOCK and DATA TRANSITIONS: The SDA pin is normally pulled high with an external device. Data on the SDA pin may change only during SCL low time periods (refer to Data Validity timing diagram). Data changes during SCL high periods will indicate a start or stop condition as defined below.

START CONDITION: A high-to-low transition of SDA with SCL high is a start condition which must precede any other command (refer to Start and Stop Definition timing diagram).

STOP CONDITION: A low-to-high transition of SDA with SCL high is a stop condition. After a read sequence, the stop command will place the device in a standby power mode (refer to Start and Stop Definition timing diagram).

ACKNOWLEDGE: All addresses and data are serially

transmitted to and from the device in 8 bit words. The device sends a zero to acknowledge that it has received each byte. This happens during the ninth clock cycle.

STANDBY MODE: The AT88SC153 features a low power standby mode which is enabled: (a) upon power-up and (b) after the receipt of the STOP bit and the completion of any internal operations.

ACKNOWLEDGE POLLING: Once the internally-timed write cycle has started and the device inputs are disabled, acknowledge polling can be initiated. This involves sending a start condition followed by the command byte representative of the operation desired. Only if the internal write cycle has completed will the device respond with a zero, allowing the sequence to continue.

Start and Stop Definition

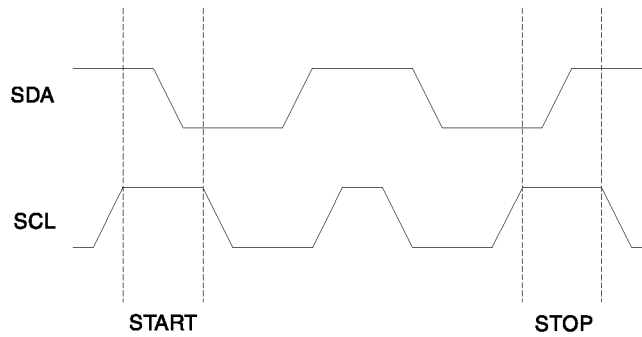

Note: The SCL input should be LOW when the device is idle. Therefore, SCL is LOW before a start condition and after a stop condition.

Data Validity

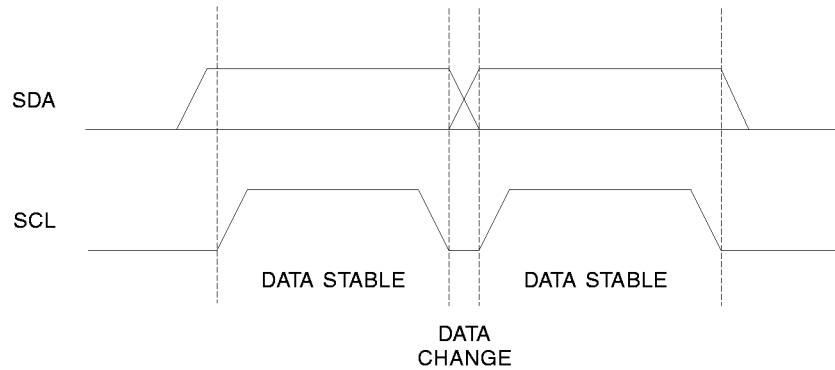

Output Acknowledge

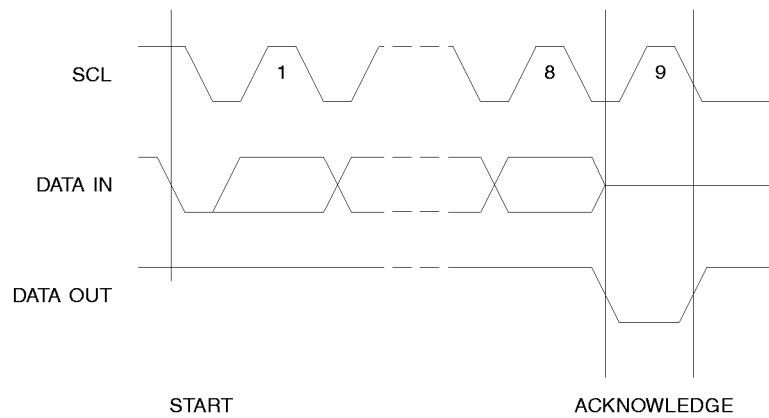

Note: To transmit a NACK (no acknowledge), hold data (SDA) high during the entire 9th clock cycle.

Absolute Maximum Ratings*

Operating Temperature	-55°C to +125°C
Storage Temperature	-65°C to +150°C
Voltage on Any Pin with Respect to Ground	-0.7V to $V_{CC} + 0.7V$
Maximum Operating Voltage	6.25V
DC Output Current	5.0 mA

*NOTICE: Stresses beyond those listed under “Absolute Maximum Ratings” may cause permanent damage to the device. This is a stress rating only and functional operation of the device at these or any other conditions beyond those indicated in the operational sections of this specification is not implied. Exposure to absolute maximum rating conditions for extended periods may affect device reliability.

DC Characteristics

Applicable over recommended operating range from: $V_{CC} = +2.7V$ to $5.5V$, $T_{AC} = 0^{\circ}C$ to $+70^{\circ}C$ (unless otherwise noted).

Symbol	Parameter	Test Condition	Min	Typ	Max	Units
$V_{CC}^{(1)}$	Supply Voltage		2.7		5.5	V
I_{CC}	Supply Current ($V_{CC} = 5.0V$)	READ at 1 MHz ⁽²⁾			5.0	mA
I_{CC}	Supply Current ($V_{CC} = 5.0V$)	WRITE at 1 MHz			5.0	mA
$I_{SB1}^{(1)}$	Standby Current ($V_{CC} = 2.7V$)	$V_{IN} = V_{CC}$ or GND			1.0	μA
I_{SB2}	Standby Current ($V_{CC} = 5.0V$)	$V_{IN} = V_{CC}$ or GND			5.0	μA
I_{LI}	Input Leakage Current	$V_{IN} = V_{CC}$ or GND			1.0	μA
I_{LO}	Output Leakage Current	$V_{OUT} = V_{CC}$ or GND			1.0	μA
V_{IL}	Input Low Level ⁽³⁾		-0.3		$V_{CC} \times 0.3$	V
V_{IH}	Input High Level ⁽³⁾		$V_{CC} \times 0.7$		$V_{CC} + 0.5$	V
V_{OL2}	Output Low Level ($V_{CC} = 2.7V$)	$I_{OL} = 2.1$ mA			0.4	V

- Notes:
1. This parameter is preliminary and Atmel may change the specifications upon further characterization.
 2. Output not loaded.
 3. V_{IL} min and V_{IH} max are reference only and are not tested.

AC Characteristics

Applicable over recommended operating range from $T_A = 0^\circ\text{C}$ to $+70^\circ\text{C}$, $V_{CC} = +2.7\text{V}$ to $+5.5\text{V}$, $CL = 1$ TTL Gate and 100 pF (unless otherwise noted).

Symbol	Parameter	5.0 Volt		Units
		Min	Max	
f_{SCL}	Clock Frequency, SCL		1.0	MHz
t_{LOW}	Clock Pulse Width Low	400		ns
t_{HIGH}	Clock Pulse Width High	400		ns
t_{AA}	Clock Low to Data Out Valid		550	ns
$t_{HD,STA}$	Start Hold Time	200		ns
$t_{SU,STA}$	Start Set-up Time	200		ns
$t_{HD,DAT}$	Data In Hold Time	0		ns
$t_{SU,DAT}$	Data In Set-up Time	100		ns
t_R	Inputs Rise Time ^(1,2)		300	ns
t_F	Inputs Fall Time ^(1,2)		100	ns
$t_{SU,STO}$	Stop Set-up Time	200		ns
t_{DH}	Data Out Hold Time	0		ns
t_{WR}	Write Cycle Time		10	ms
t_{RST}	Reset Width High	600		ns
$t_{SU,RST}$	Reset Set-up Time	50		ns
$t_{HD,RST}$	Reset Hold Time	50		ns
t_{BUF}	Period of time the bus must be free before a new command can start ⁽¹⁾		500	ns

- Notes: 1. This parameter is characterized and is not 100% tested.
2. Input rise and fall transitions must be monotonic.

Pin Capacitance

Applicable at recommended operating condition $T_A = 25^\circ\text{C}$, $f = 1.0\text{ MHz}$, $V_{CC} = +2.7\text{V}$.

Symbol	Test Condition	Max	Units	Conditions
$C_{I/O}$	Input/Output Capacitance (SDA) ⁽¹⁾	8	pF	$V_{I/O} = 0\text{V}$
C_{IN}	Input Capacitance (RST, SCL) ⁽¹⁾	6	pF	$V_{IN} = 0\text{V}$

- Note: 1. This parameter is characterized and is not 100% tested.

Bus Timing SCL: Serial Clock SDA: Serial Data I/O

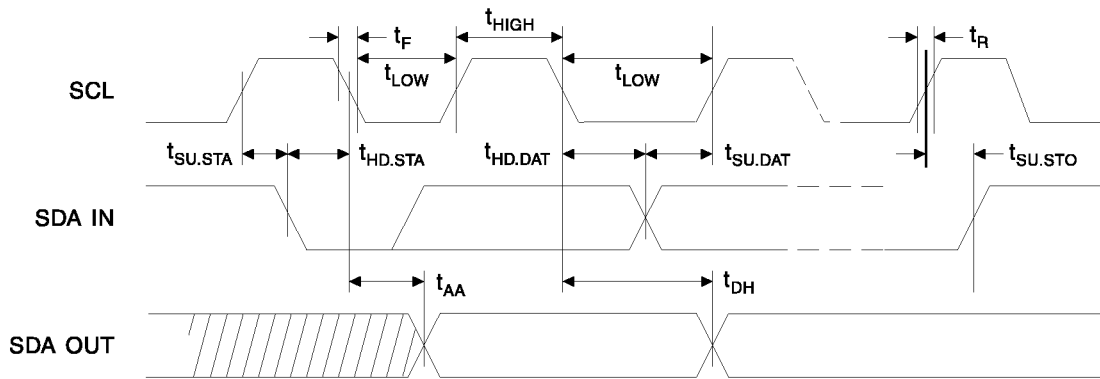

Synchronous Answer-to-Reset Timing

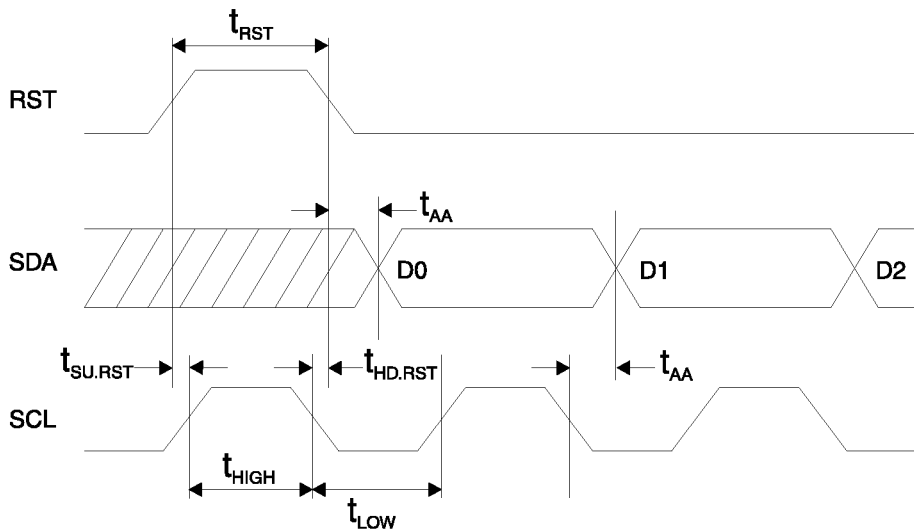

Write Cycle Timing SCL: Serial Clock SDA: Serial Data I/O

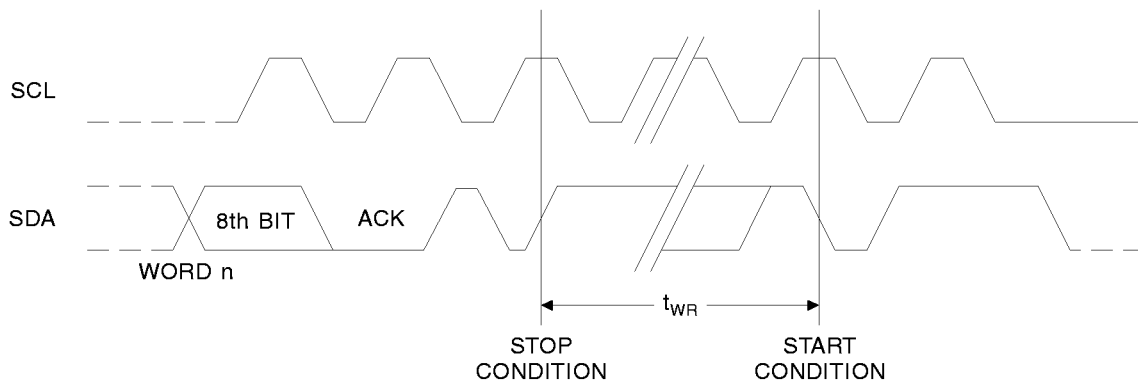

Note: Note: The write cycle Time t_{WR} is the time from valid stop condition of a write sequence to the end of the internal clear/write cycle.



Ordering Information

Ordering Code ⁽¹⁾	Package ⁽²⁾	Voltage Range	Temperature Range
AT88SC153 - 09AT - xx - 2.7 AT88SC153 - 09BT - xx - 2.7 AT88SC153 - 09CT - xx - 2.7 AT88SC153 - 09DT - xx - 2.7 AT88SC153 - 09ET - xx - 2.7 AT88SC153 - 09GT - xx - 2.7 AT88SC153 - 09HT - xx - 2.7 AT88SC153 - 10SC - xx - 2.7 AT88SC153 - 10WC - xx - 2.7 AT88SC153 - 10PC - xx - 2.7 AT88SC153 - 10CC - xx - 2.7	M2 - A Module M2 - B Module M4 - C Module M4 - D Module M2 - E Module M3 - G Module M3 - H Module 8S1 8S2 8P3 8C	2.7V to 3.3V	Commercial 0°C to 70°C
AT88SC153 - 09AT - xx AT88SC153 - 09BT - xx AT88SC153 - 09CT - xx AT88SC153 - 09DT - xx AT88SC153 - 09ET - xx AT88SC153 - 09GT - xx AT88SC153 - 09HT - xx AT88SC153 - 10SC - xx AT88SC153 - 10WC - xx AT88SC153 - 10PC - xx AT88SC153 - 10CC - xx	M2 - A Module M2 - B Module M4 - C Module M4 - D Module M2 - E Module M3 - G Module M3 - H Module 8S1 8S2 8P3 8C	4.5V to 5.5V	Commercial 0°C to 70°C

Package Type ⁽²⁾	
M2 - A Module	M2 ISO 7816 Smart Card Module
M2 - B Module	M2 ISO 7816 Smart Card Module with Atmel Logo
M4 - C Module	M4 ISO 7816 Smart Card Module
M4 - D Module	M4 ISO 7816 Smart Card Module with Atmel Logo
M2 - E Module	M2 ISO 7816 Smart Card Module
M3 - G Module	M3 ISO 7816 Smart Card Module
M3 - H Module	M3 ISO 7816 Smart Card Module with Atmel Logo
8S1	8-Lead, 0.150" Wide, Plastic Gull Wing Small Outline Package (JEDEC SOIC)
8S2	8-Lead, 0.200" Wide, Plastic Gull Wing Small Outline Package (EIAJ SOIC)
8P3	8-Lead, 0.300" Wide, Plastic Dual Inline Package (PDIP)
8C	8-Lead, 0.230" Wide, Leadless Array Package (LAP)

- Notes: 1. "xx" must be replaced by a security code. Contact an Atmel Sales Office for the security code.
2. Formal drawings may be obtained from an Atmel Sales Office.

Smart Card Modules

M2 - A Module - Ordering Code: 09AT

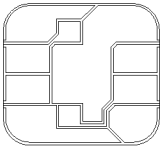

Module Size: M2
 Dimension⁽¹⁾: 12.6 x 11.4 mm
 Glob Top: Black, Square: 8.6 x 8.6 mm
 Thickness: 0.58 mm max.
 Pitch: 14.25 mm

M2 - E Module - Ordering Code: 09ET

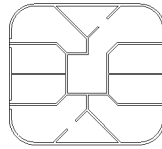

Module Size: M2
 Dimension⁽¹⁾: 12.6 x 11.4 mm
 Glob Top: Clear, Round: Ø 7.5 mm max.
 Thickness: 0.58 mm max.
 Pitch: 14.25 mm

M2 - B Module - Ordering Code: 09BT

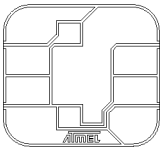

Module Size: M2
 Dimension⁽¹⁾: 12.6 x 11.4 mm
 Glob Top: Black, Square: 8.6 x 8.6 mm
 Thickness: 0.58 mm max.
 Pitch: 14.25 mm

M3 - G Module - Ordering Code: 09GT

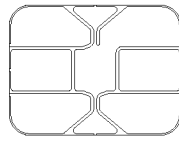

Module Size: M3
 Dimension⁽¹⁾: 10.6 x 8.0 mm
 Glob Top: Clear, Round: Ø 6.5 mm max.
 Thickness: 0.58 mm max.
 Pitch: 9.5 mm

M4 - C Module - Ordering Code: 09CT

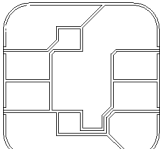

Module Size: M4
 Dimension⁽¹⁾: 12.6 x 12.6 mm
 Glob Top: Black, Square: 8.6 x 8.6 mm
 Thickness: 0.58 mm
 Pitch: 14.25 mm

M3 - H Module - Ordering Code: 09HT

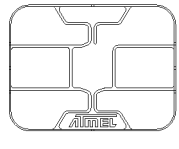

Module Size: M3
 Dimension⁽¹⁾: 10.6 x 8.0 mm
 Glob Top: Clear, Round: Ø 6.5 mm max.
 Thickness: 0.58 mm max.
 Pitch: 9.5 mm

M4 - D Module - Ordering Code: 09DT

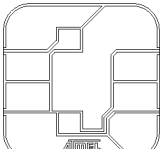

Module Size: M4
 Dimension⁽¹⁾: 12.6 x 12.6 mm
 Glob Top: Black, Square: 8.6 x 8.6 mm
 Thickness: 0.58 mm max.
 Pitch: 14.25 mm

Note: 1. The module dimensions listed refer to the dimensions of the exposed metal contact area. The actual dimensions of the module after excise or punching from the carrier tape are generally 0.4 mm greater in both directions (i.e. a punched M2 module will yield 13.0 x 11.8 mm).

Packaging Information

8S1, 8-lead, 0.150" Wide, Plastic Gull Wing Small Outline (JEDEC SOIC)
Dimensions in Inches and (Millimeters)

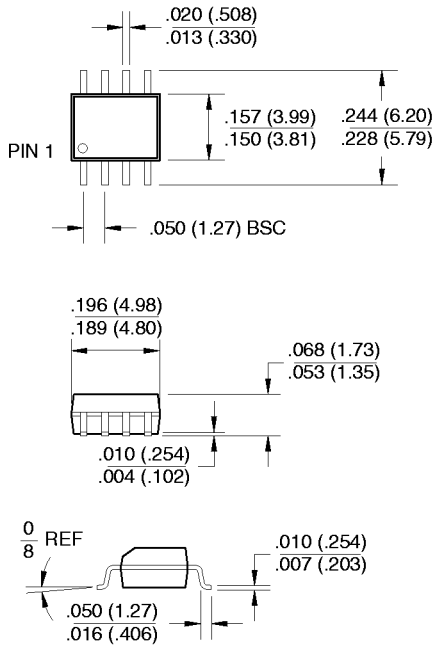

8S2, 8-lead, 0.210" Wide, Plastic Gull Wing Small Outline (EIAJ SOIC)
Dimensions in Inches and (Millimeters)

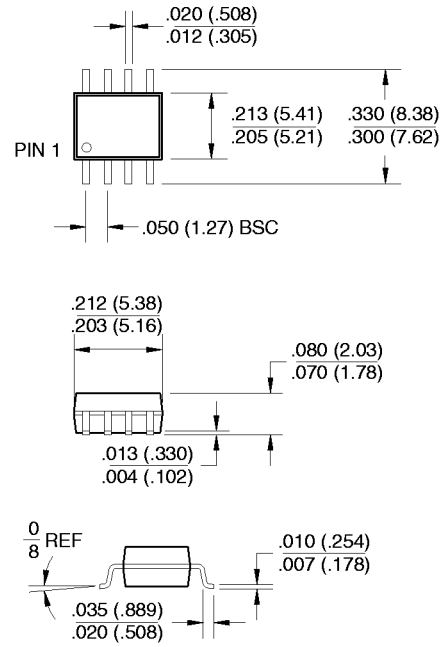

8P3, 8-lead, 0.300" Wide, Plastic Dual Inline Package (PDIP)
Dimensions in Inches and (Millimeters)

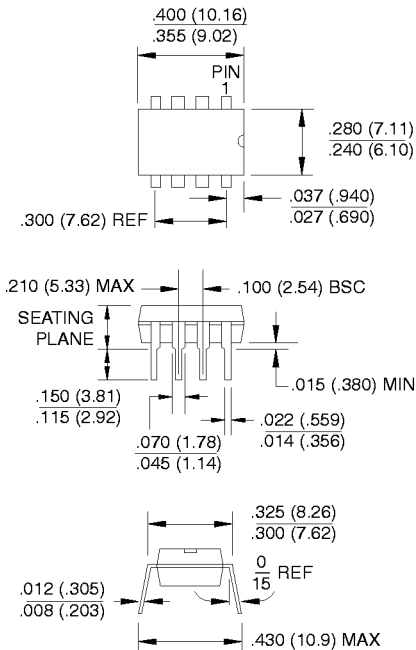

8C, 8-lead, 0.300" Wide, Leadless Array Package (LAP)
Dimensions in Inches and (Millimeters)

