



The Future of Analog IC Technology™

EV2364DF/1541DJ-00A

4 Output
DSL Power Supply

EVALUATION BOARD – INITIAL RELEASE

GENERAL DESCRIPTION

The EV2364/1541-00A is an evaluation board for DSL Power applications. It has four outputs and can supply 1.5A continuous output current over a wide input supply range with excellent load and line regulation. Current mode operation provides fast transient response and eases loop stabilization. Fault condition protection includes cycle-by-cycle current limiting and thermal shutdown.

ELECTRICAL SPECIFICATIONS

Parameter	Symbol	Value	Units
Input Voltage	V _{IN}	5 – 23	V
Output Voltage A	V _{OUTA}	3.3	V
Output Current A	I _{OUTA}	1.5	A
Output Voltage B	V _{OUTB}	1.8	V
Output Current B	I _{OUTB}	1.5	A
Output Voltage C	V _{OUTC}	12.8	V
Output Current C	I _{OUTC}	100	mA
Output Voltage D	V _{OUTD}	5	V
Output Current D	I _{OUTD}	100	mA

FEATURES

- 1.5A Current for 3.3V and 1.8V Outputs
- Ceramic Input and Output Capacitors
- High Efficiency
- Fixed Operating Frequency
- Wide 5V to 23V Operating Input Range
- Adjustable Output
- Programmable Under Voltage Lockout
- Programmable Soft-Start

APPLICATIONS

- Distributed Power Systems
- I/O and Core Supplies
- DSL Modems
- Set Top Boxes
- Cable Modems

"MPS" and "The Future of Analog IC Technology" are Trademarks of Monolithic Power Systems, Inc.

EV2364DF/1541DJ-00A EVALUATION BOARD

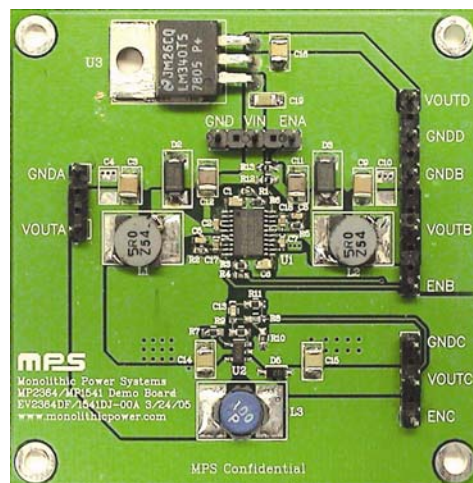

Dimensions (2.6"X x 2.6"Y x 0.4"Z)

Board Number	MPS IC Number
EV2364DF/1541DJ-00A	MP2364DF and MP1541DJ

PERFORMANCE CURVES

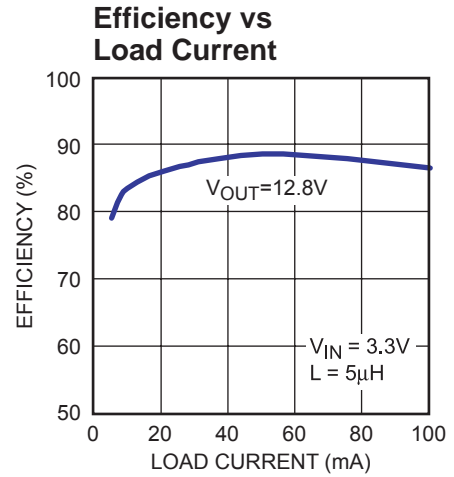
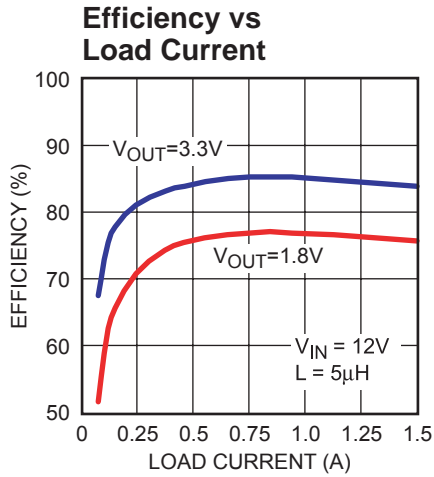

EV2364_1541_EC01-02

EVALUATION BOARD SCHEMATIC

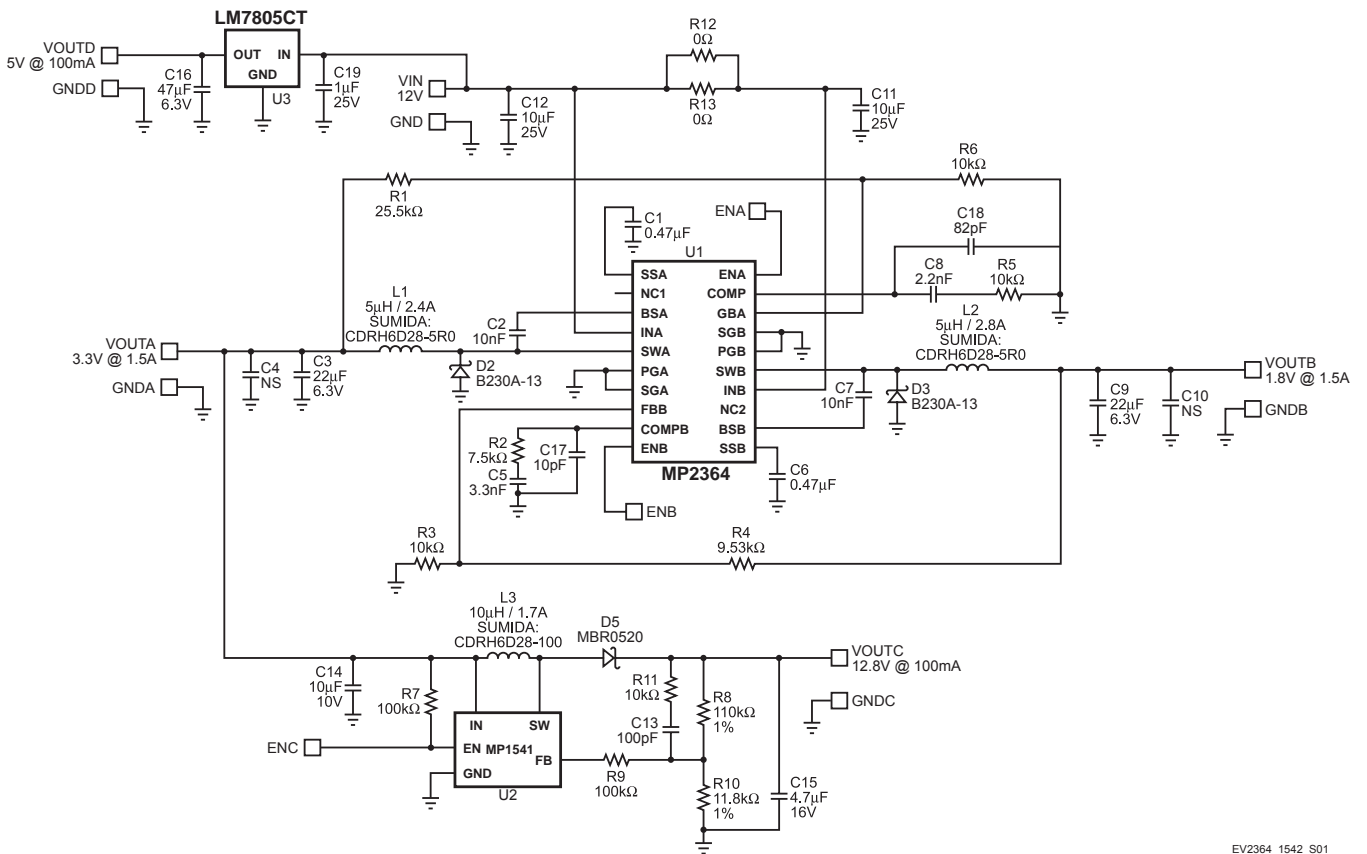

EV2364_1542_S01



EV2364DF/1541DJ-00A BILL OF MATERIALS

Qty	Ref	Value	Description	Package	Manufacturer Part No.	Distributor Part No.
2	C1, C6	0.47 μ F	Ceramic Capacitor, 16V, X7R	0805	TDK: C2012X7R1C474K	Digikey: 445-1357-1-ND
2	C2, C7	10nF	Ceramic Capacitor, 50V, X7R	0603	TDK: C1608X7R1H103K	Digikey: 445-1311-1-ND
2	C3, C9	22 μ F	Ceramic Capacitor, 6.3V, X5R	1210	TDK: C3225X5R0J226M	Digikey: 445-1404-1-ND
2	C4, C10		Not used			
1	C5	3.3nF	Ceramic Capacitor, 50V, X7R	0603	Panasonic: ECJ-1VB1H332K	Digikey: PCC1778CT-ND
1	C8	2.2nF	Ceramic Capacitor, 50V, X7R	0603	TDK: C1608X7R1H222K	Digikey: 445-1309-1-ND
2	C11, C12	10 μ F	Ceramic Capacitor, 25V, X7R	1210	TDK: C3225X7R1E106M	Digikey: 445-1434-1-ND
1	C13	100pF	Ceramic Capacitor, 50V, C0G	0603	TDK: C1608C0G1H101J	Digikey: 445-1281-1-ND
1	C14	10 μ F	Ceramic Capacitor, 10V, X5R	1210	Panasonic: ECJ-4YB1A106K	Digikey: PCC2170CT-ND
1	C15	4.7 μ F	Ceramic Capacitor, 16V, X5R	1210	Panasonic: ECJ-4YB1C475K	Digikey: PCC2168TR-ND
1	C16	47 μ F	Ceramic Capacitor, 6.3V, X5R	1210	Murata: GRM32ER60J476ME20L	Digikey: 490-1887-1-ND
1	C17	10pF	Ceramic Capacitor, 50V, X5R	0603	Murata: GRM1885C1H100JA01D	Digikey: 490-1403-1-ND
1	C18	82pF	Ceramic Capacitor, 50V, X5R	0603	Murata: GRM1885C1H820JA01D	Digikey: 490-1425-2-ND
1	C19	1 μ F	Ceramic Capacitor, 25V, X5R	1210	Murata: GRM31C5C1E104JA01L	Digikey: 490-1767-2-ND
2	D2, D3		Schottky Diode, 30V, 2A, SMA		Diodes Inc: B230A-13	Digikey: B230ADICT-ND
1	D5		Schottky Diode, 20V, 0.5A	SOD-123	ON Semiconductor: MBR0520LT1	Digikey: MBR0520LT1OSCT-ND
2	L1, L2	5 μ H	2.4A, SMD, Unshielded		Sumida: CDRH6D28-5R0	
1	L3	10 μ H	1.7A		Sumida: CDRH6D28-100NC	
1	R1	25.5k Ω	Metal Film Resistor, 1%	0603	Panasonic: ERJ-3EKF2552V	Digikey: P25.5KHCT-ND
1	R2	7.5k Ω	Metal Film Resistor, 5%	0603	Panasonic: ERJ-3GEYJ752V	Digikey: P7.5KGCT-ND
4	R3, R5, R6, R11	10k Ω	Metal Film Resistor, 1%	0603	Panasonic: ERJ-3EKF1002V	Digikey: P10.0KHCT-ND
1	R4	9.53k Ω	Metal Film Resistor, 1%	0603	Panasonic: ERJ-3EKF9531V	Digikey: P9.53KHCT-ND
2	R7, R9	100k Ω	Resistor, 1%	0603	Panasonic: ERJ-3EKF1003V	Digikey: P100KHCT-ND

EV2364DF/1541DJ-00A BILL OF MATERIALS (continued)

Qty	Ref	Value	Description	Package	Manufacturer Part No.	Distributor Part No.
1	R8	110kΩ	Resistor, 1%	0603	Panasonic: ERJ-3EKF1103V	Digikey: P110KHDKR-ND
1	R10	11.8kΩ	Resistor, 1%	0603	Panasonic: ERJ-3EKF1182V	Digikey: P11.8KHCT-ND
2	R12, R13	0Ω	Resistor, 5%	0603	Panasonic: ERJ-3GEY0R00V	Digikey: P0.0GTR-ND
1	U1		DC/DC Controller	TSSOP20	MPS: MP2364DF	
1	U2		1.3MHz Boost Converter	SOT23-5	MPS: MP1541	
1	U3		5 Volt Regulator		National Semi: LM7805CT	

PRINTED CIRCUIT BOARD LAYOUT

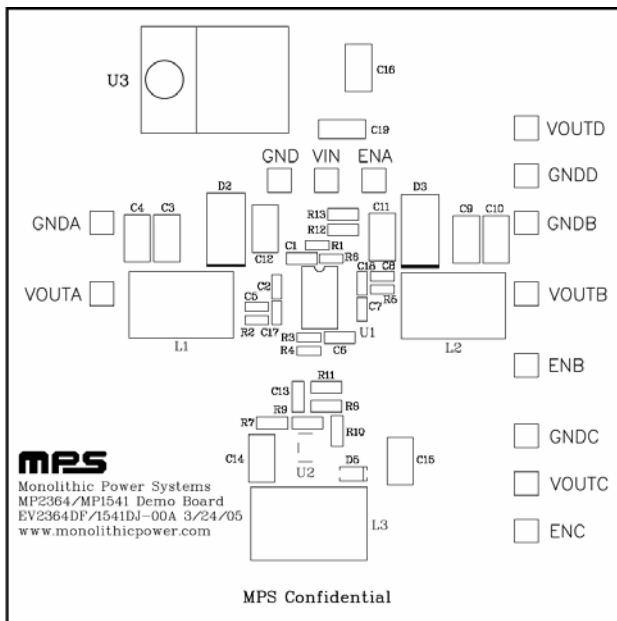

Figure 1—Top Silk Layer

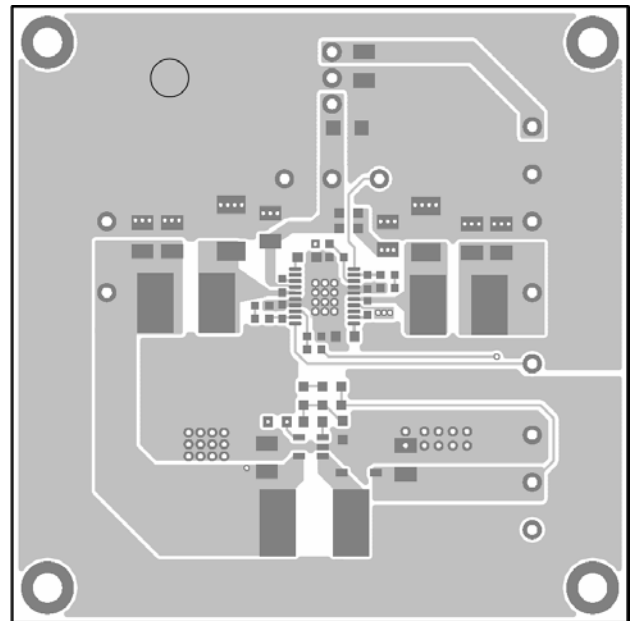

Figure 2—Top Layer

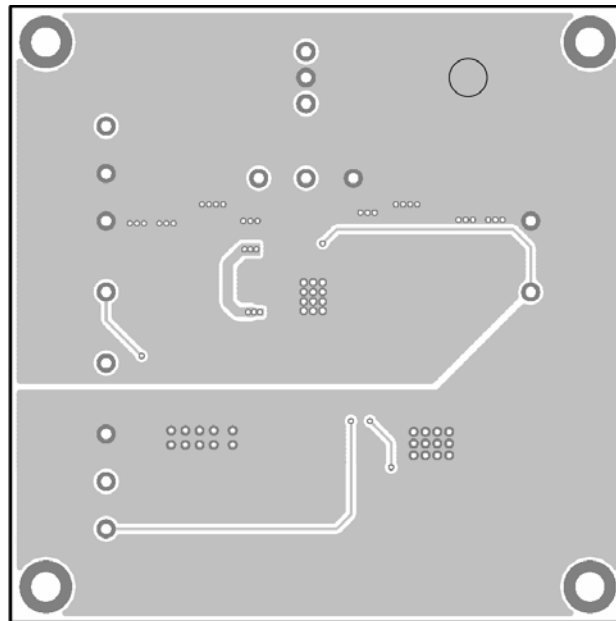

Figure 3—Bottom Layer

QUICK START GUIDE

The output voltages of this board are set to 3.3V (VOUTA), 1.8V (VOUTB), 12.8V (VOUTC) and 5V (VOUTD). The board layout accommodates most commonly used inductors and output capacitors.

1. Attach the positive and negative ends of the first load to the VOUTA and GND pins, respectively. If using other outputs, attach the positive and negative ends of their loads to the respective VOUT and GND pins for the desired outputs.
2. Preset the power supply output to 5V to 23V and turn it off.
3. Connect the positive terminal of the power supply output to the VIN pin and the negative terminal of the to the GND pin.
4. Turn on the power supply. The EV2364DF/1541DJ will automatically startup.
5. To use the Enable function, apply a digital input to the ENA/ENB pins. Drive EN higher than 2.5V to turn on the regulator and less than 0.7V to turn it off.

NOTICE: The information in this document is subject to change without notice. Please contact MPS for current specifications. Users should warrant and guarantee that third party Intellectual Property rights are not infringed upon when integrating MPS products into any application. MPS will not assume any legal responsibility for any said applications.