

Surface-mount type power supply unit for LCD drives

BP5307

The BP5307 is a DC / DC converter unit designed for driving liquid crystal displays (LCDs). The unit supplies a positive voltage for LCDs from a logic circuit power supply (+5V). Being in a compact and light surface-mount package, the IC can be built into a LCD panel.

●Applications

LCD panels of personal computers, word processors, and copiers

●Features

- 1) Automatic mounting and reflow soldering are possible.
- 2) With a maximum thickness of 4.1mm, the IC can be built into a LCD panel.
- 3) Output voltage can be regulated by a microcontroller.
- 4) Discharge circuit is built in for output. (Fall time: 1ms Typ.)

●Absolute maximum ratings (Ta = 25°C)

Parameter	Symbol	Limits	Unit
Power supply voltage	V _{IN}	7.0	V
Operating temperature	T _{opr}	0~+60	°C
Storage temperature	T _{stg}	-20~+85	°C

●Block diagram

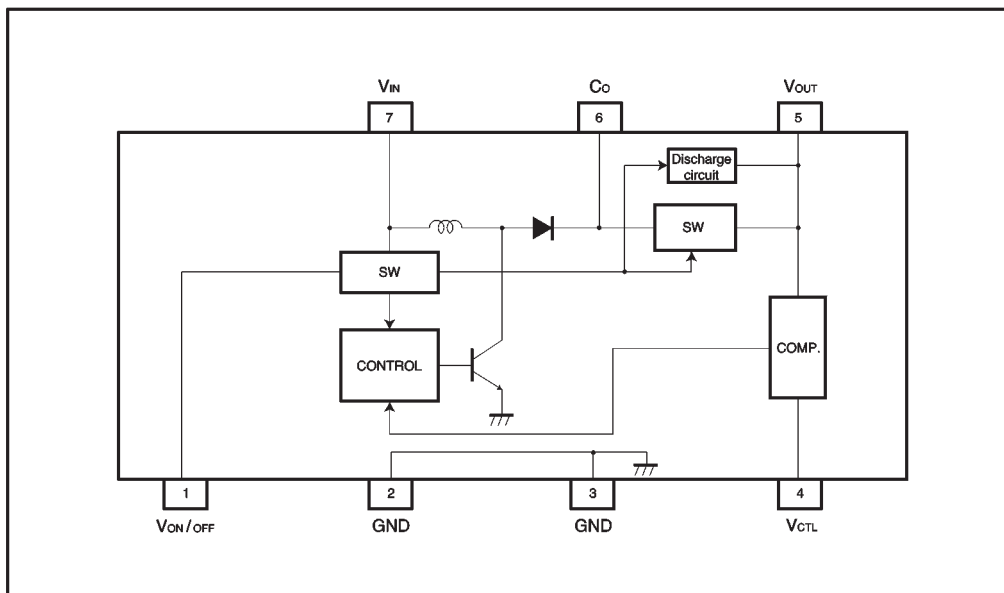

● Pin descriptions

Pin No.	Pin name	Function
1	V _{ON/OFF}	Output ON/OFF control ; output starts when the pin is HIGH level, and stops when the pin is LOW or OPEN
2	GND	Internally connected ground
3	GND	
4	V _{CTL}	Output voltage can be adjusted by the input voltage of 0.8-2.8 V, which is available even when the pin is OPEN; typically V _{OUT} = 34V when OPEN
5	V _{OUT}	Output; connect a low-impedance capacitor with a recommended capacitance of 47 μ F between this pin and GND
6	C _O	External capacitor connection ; connect a low-impedance capacitor with a recommended capacitance of 10 μ F between this pin and GND
7	V _{IN}	Input; connect a low-impedance capacitor with a recommended capacitance of 1 μ F between this pin and GND

● Electrical characteristics (unless otherwise noted, Ta = 25°C and V_{CTL} = 0.8V)

Parameter	Symbol	Min.	Typ.	Max.	Unit	Conditions
Input voltage	V _{IN}	4.5	5.0	5.5	V	—
Output current	I _{OUT}	0	—	40	mA	V _{CTL} =0.8~2.8V
Output voltage 1	V _{OUT1}	30.00	32.00	33.60	V	V _{IN} =4.5~5.5V V _{CTL} =0.8V, I _{OUT} =0~40mA
Output voltage 2	V _{OUT2}	16.00	19.00	20.00	V	V _{IN} =4.5~5.5V V _{CTL} =2.8V, I _{OUT} =0~40mA
Ripple noise voltage	V _r	—	200	300	mV _{P-P}	V _{IN} =5V, I _{OUT} =40mA*
Efficiency	η	60	70	—	%	V _{IN} =5V, I _{OUT} =40mA
ON/OFF CTL voltage when ON	V _{ON}	2.5	—	5.5	V	V _{IN} =4.5~5.5V Output ON
ON/OFF CTL voltage when OFF	V _{OFF}	—	—	0.7	V	V _{IN} =4.5~5.5V Output OFF
V _{CTL} applied voltage	V _{CTL}	0	—	4.0	V	—
Oscillation frequency	f _{sw}	—	100	—	kHz	—

* Measured with a band width of 20 MHz.

● Measurement circuit

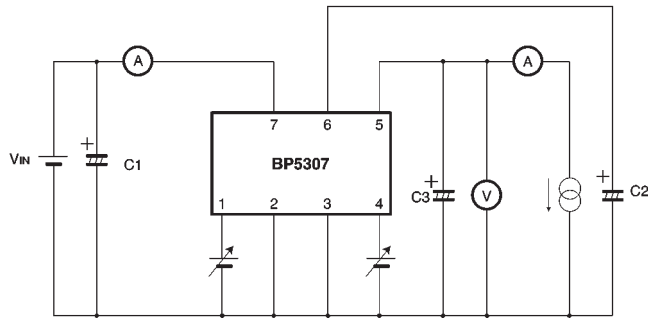

Fig. 1

- C1 : 10 μ F / 50V (NICHICON PL-series or equivalent)
- C2 : 10 μ F / 50V (NICHICON PL-series or equivalent)
- C3 : 47 μ F / 50V (NICHICON PL-series or equivalent)

● Electrical characteristic curves

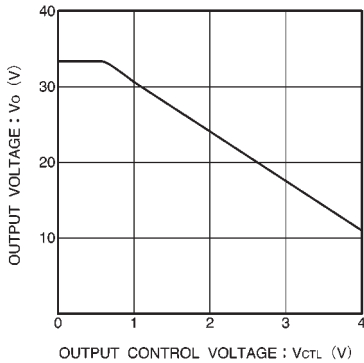

Fig. 2 Output voltage vs. output control voltage

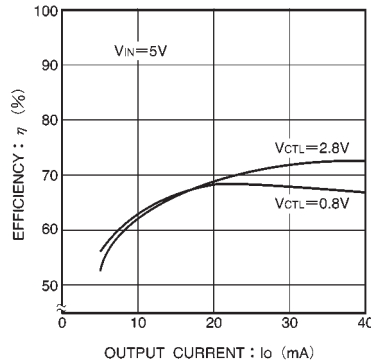

Fig. 3 Efficiency

● Recommended pad dimensions

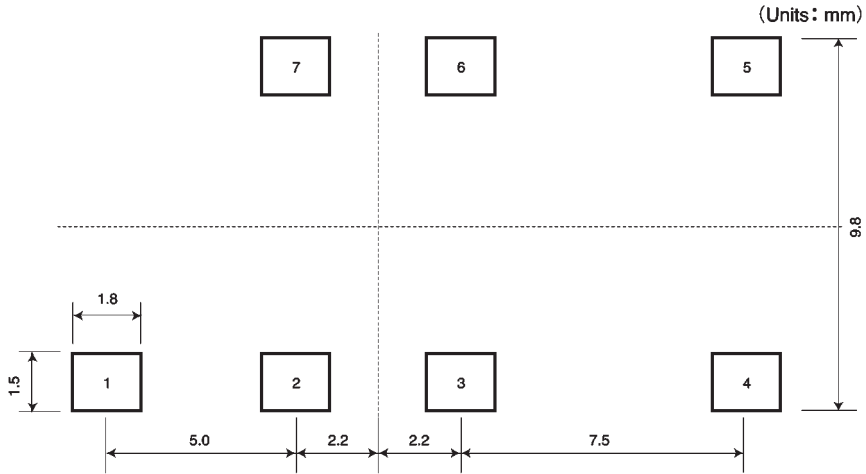

Fig. 4

● Operation notes

The soldering used inside the unit is equivalent to H63 solder, so it will remelt during reflow. Be sure not to subject the unit to any vibrations when passing through the reflow furnace.

● External dimensions (Units: mm)

