

GQ2133

CMOS Positive Voltage Regulator

Description

The GQ2133 series of positive, linear regulators feature low quiescent current (30µA typ.) with low dropout voltage, making them ideal for battery applications.

These rugged devices have both Thermal Shutdown, and Current Fold-back to prevent device failure under the "Worst" of operating conditions.

An additional feature is a "Power Good" detector, which pulls low when the output is out of regulation.

The GQ2133 is stable with an output capacitance of 2.2µF or greater.

Features

- Very Low Dropout Voltage
- Guaranteed 300mA output
- Over-Temperature Shutdown
- Current Limiting
- Short Circuit Current Fold-back
- Highly Accurate ± 1.5%
- Power Good Output Function
- Power-saving Shutdown Mode
- Factor Pre-set Output Voltage

Applications

- Battery Powered Widgets
- Instrumentation
- Wireless Devices
- PC Peripherals
- Portable Electronics
- Cordless Phones
- Electronic Scales

Package Dimensions

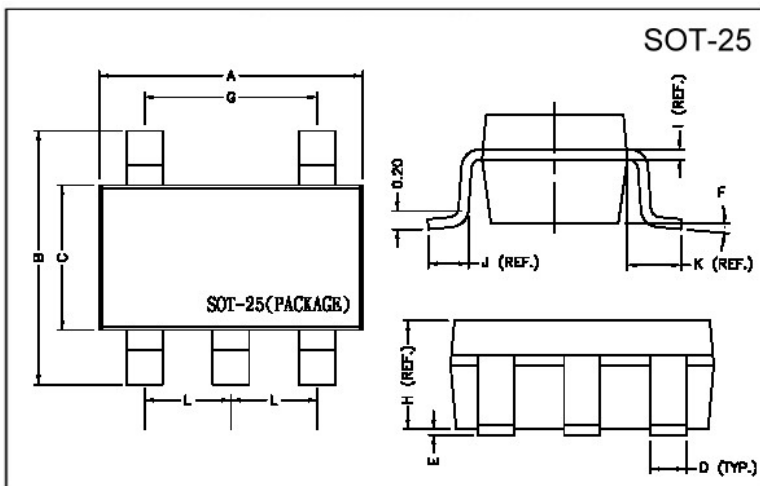

Functional Block Diagram

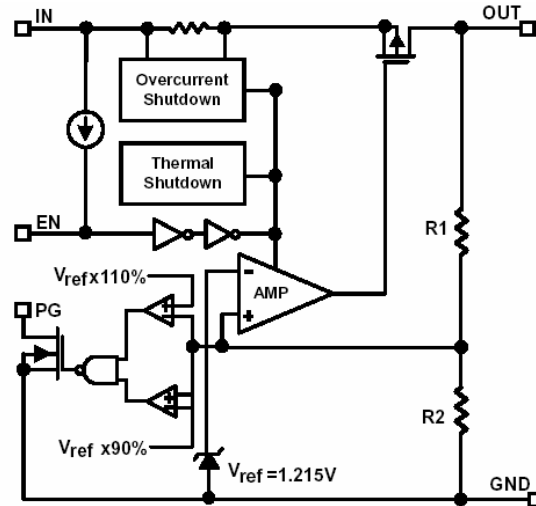

Note: If output voltage specification is lower than 1.215V, V_{ref} will be trimmed to 1.2V

Marking :

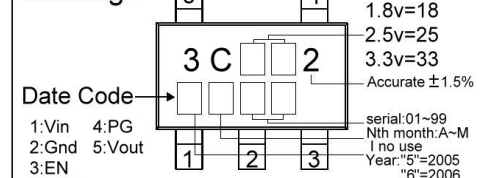

REF.	Millimeter		REF.	Dimensions Millimeter
	Min.	Max.		
A	2.70	3.10	G	1.90 REF.
B	2.60	3.00	H	1.20 REF.
C	1.40	1.80	I	0.12 REF.
D	0.30	0.55	J	0.37 REF.
E	0	0.10	K	0.60 REF.
F	0°	10°	L	0.95 REF.

Typical Application Circuit

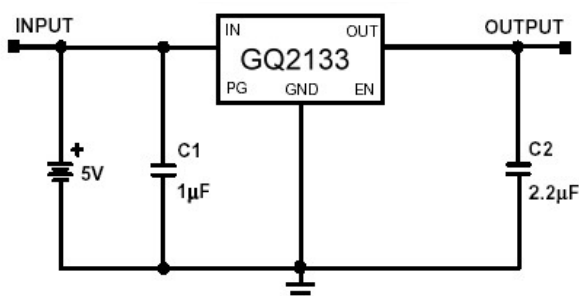

Absolute Maximum Ratings

Parameter	Symbol	Ratings	Unit
Input Max Voltage	V _{IN}	8	V
Output Current	I _{OUT}	PD/(V _{IN} -V _O)	mA
Output Voltage	V _{OUT}	1.2~3.8	V
Operating Ambient Temperature	T _{opr}	-40 ~ +85	°C
Junction Temperature	T _j	-40 ~ +125	°C
Maximum Junction Temperature	T _{j Max}	150	°C
Thermal Resistance	θ _{ja}	260	°C/W
Power Dissipation(ΔT=100°C)	PD	380	mW
EDS Classification		B	

Electrical Characteristics Ta=25°C unless otherwise noted

Parameter	Symbol	Condition	Min	TYP	Max	Unit	
Output Voltage	V _{OUT(E)} (Note1)	V _{IN} =V _{OUT(T)} +2V, I _O =1mA	-1.5%	V _{OUT(T)} (Note2)	1.5%	V	
Output Current	I _O	V _{IN} =V _{OUT(T)} +2V, V _{OUT} ≥V _{OUT(E)} *0.96	300	-	-	mA	
Current Limit	I _{LIM}	V _{IN} =V _{OUT(T)} +2V, V _O >1.2V	300	450	-	mA	
Load Regulation	REG _{LOAD}	V _{IN} =V _{OUT(T)} +2V, I _O =1mA to 300mA	-1	0.2	1	%	
Dropout Voltage	V _{DROPOUT}	I _O =300mA V _O =V _{OUT(E)} -2%	1.2V≤V _{OUT(T)} ≤2.0V	-	-	1300	mV
			2.0V<V _{OUT(T)} ≤2.8V	-	-	400	
			2.8V<V _{OUT(T)}	-	-	300	
Quiescent Current	I _Q	V _{IN} =V _{OUT(T)} +1V, I _O =0mA	-	30	50	μA	
Ground Pin Current	I _{IGND}	V _{IN} =V _{OUT(T)} +2V, I _O =1mA~300mA	-	35	-	μA	
Line Regulation	REG _{LINE}	I _O =1mA V _{IN} =V _{OUT(T)} +1 to V _{OUT(T)} +2	1.2V≤V _{OUT(T)} ≤1.4V	-0.2	-	0.2	%
			1.4V<V _{OUT(T)} ≤2.0V	-0.15	-	0.15	
			2.0V<V _{OUT(T)} <4.0V	-0.1	0.02	0.1	
			4.0V≤V _{OUT(T)}	-0.4	0.2	0.4	
Input Voltage	V _{IN}		Note3	-	7	V	
Over Temperature Shutdown	OTS		-	150	-	°C	
Over Temperature Hysteresis	OTH		-	30	-	°C	
Vo Temperature Coefficient	TC		-	30	-	ppm/°C	
Short Circuit Current(Note4)	I _{SC}	V _{IN} =V _{OUT(T)} +1V, V _{OUT} <0.8V	-	150	300	mA	
Power Supply Rejection	PSRR	I _O =100mA C _O =2.2μF	f=100Hz	-	60	-	dB
			f=1kHz	-	50	-	
			f=10kHz	-	20	-	
Output Voltage Noise	e _N	f=10Hz~100kHz I _O =10mA		30	-	μVrms	
EN Input Threshold	V _{EH}	V _{IN} =2.7V to 7V	2.0	-	V _{IN}	V	
	V _{EL}	V _{IN} =2.7V to 7V	0	-	0.4	V	
EN Input Bias Current	I _{EH}	V _{EN} =V _{IN} , V _{IN} =2.7V to 7V	-	-	0.1	μA	
	I _{EL}	V _{EN} =0V, V _{IN} =2.7V to 7V	-	-	0.5	μA	
Shutdown Supply Current	I _{SD}	V _{IN} =5V, V _O =0V, V _{EN} <V _{EL}	-	0.5	1	μA	
Shutdown Output Voltage	V _{O,SD}	I _O =0.4mA, V _{EN} <V _{EL}	0	-	0.4	V	
Output Under Voltage	V _{UV}	2.5V≤V _{OUT(T)} ≤5.0V	-	-	85	% V _{OUT(T)}	
		1.2V≤V _{OUT(T)} <2.5V	-	-	75		
Output Over Voltage	V _{OV}	2.5V≤V _{OUT(T)} ≤5.0V	115	-	-	% V _{OUT(T)}	
		1.2V≤V _{OUT(T)} <2.5V	125	-	-		
PG Leakage Current	I _{LC}	V _{PG} =7V	-	-	1.0	μA	
PG Voltage Rating	V _{PG}	V _O in regulation	-	-	7.0	V	
PG Voltage Low	V _{OL}	I _{SINK} =0.4mA	-	-	0.4	V	

Note 1: V_{OUT(E)} =Effective Output Voltage (i.e. the output voltage when "V_{OUT(T)} + 2.0V" is provided at the V_{IN} pin while maintaining a certain I_{OUT} value).

2: V_{OUT(T)} =Specified Output Voltage

3: V_{IN(MIN)} =V_{OUT}+V_{DROPOUT}

4: To prevent the Short Circuit Current protection feature from being prematurely activated, the input voltage must be applied before a current source load is applied.

Ordering Information (contd.)

Part Number	Marking	Output Voltage	Part Number	Marking	Output Voltage
GQ2133-12	3C122 XXXX	1.2V	GQ2133-15	3C152 XXXX	1.5V
GQ2133-18	3C182 XXXX	1.8V	GQ2133-20	3C202 XXXX	2.0V
GQ2133-25	3C252 XXXX	2.5V	GQ2133-27	3C272 XXXX	2.7V
GQ2133-28	3C282 XXXX	2.8V	GQ2133-29	3C292 XXXX	2.9V
GQ2133-30	3C302 XXXX	3.0V	GQ2133-31	3C312 XXXX	3.1V
GQ2133-32	3C322 XXXX	3.2V	GQ2133-33	3C332 XXXX	3.3V
GQ2133-34	3C342 XXXX	3.4V	GQ2133-35	3C352 XXXX	3.5V
GQ2133-36	3C362 XXXX	3.6V	GQ2133-37	3C372 XXXX	3.7V
GQ2133-38	3C382 XXXX	3.8V	GQ2133-2H	3C2H2 XXXX	2.85V

Characteristics Curve

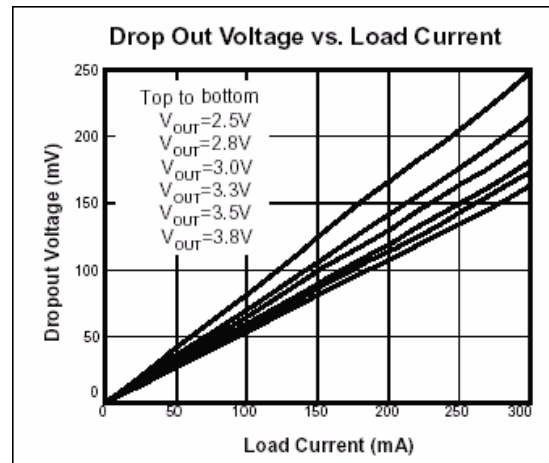
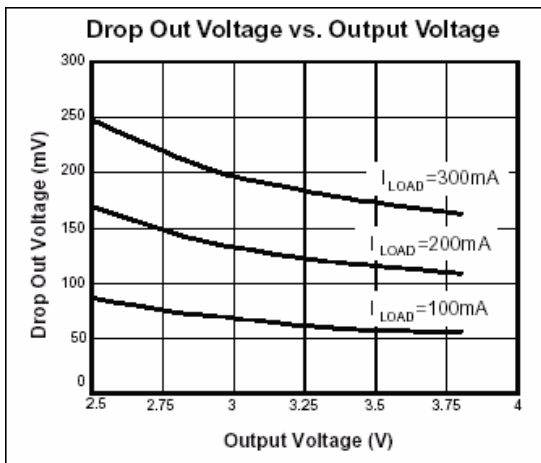
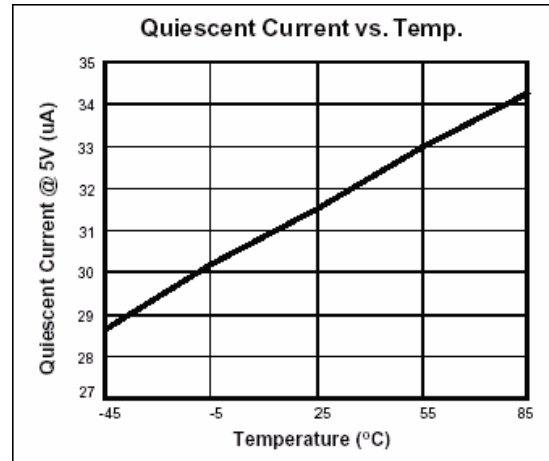
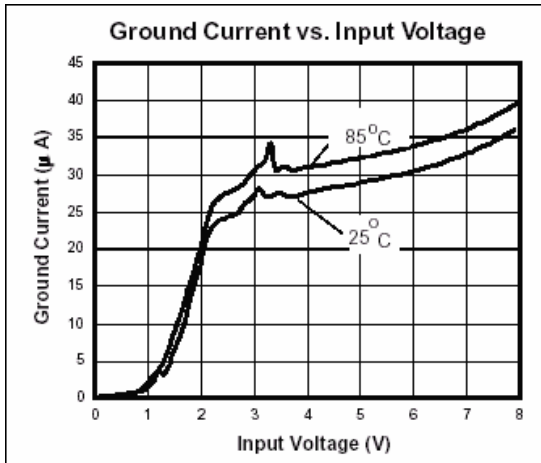

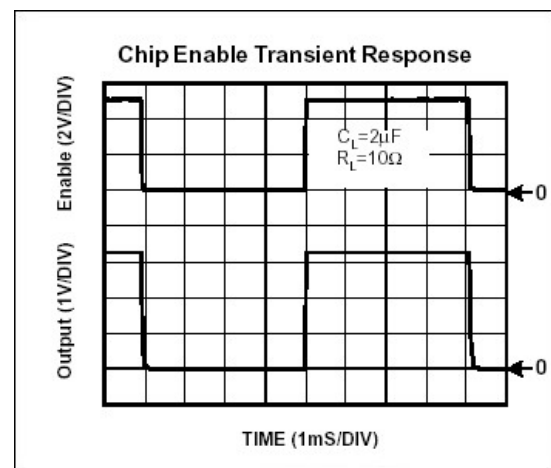
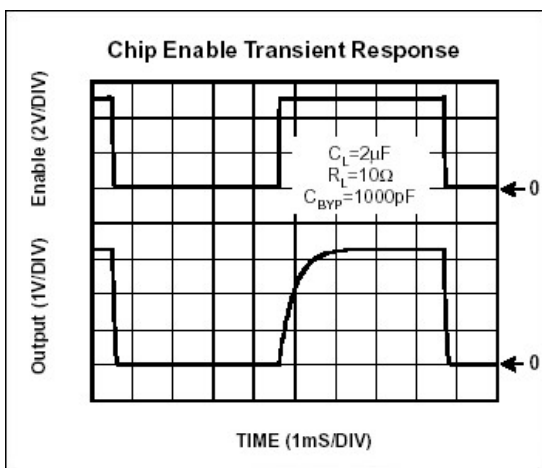
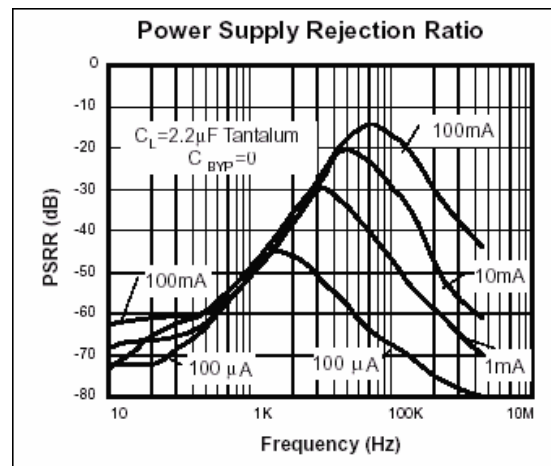
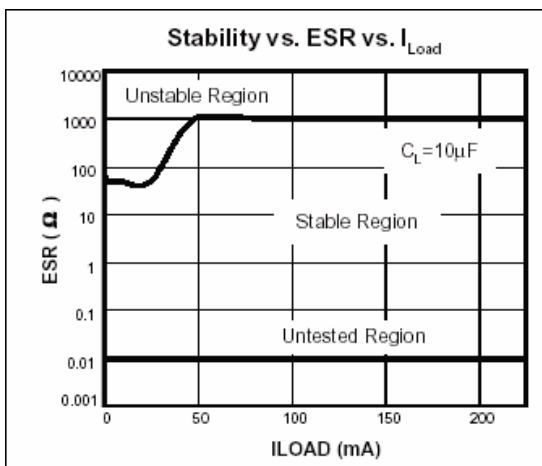
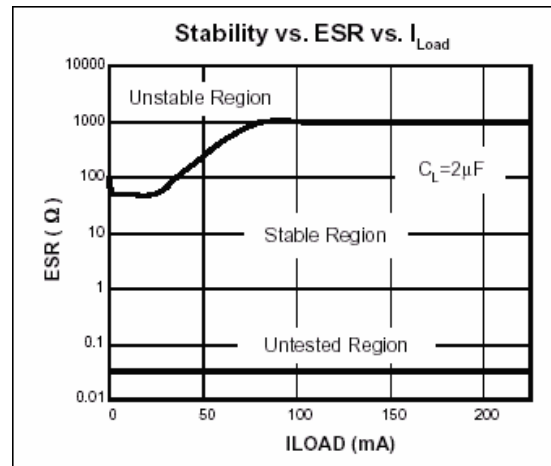
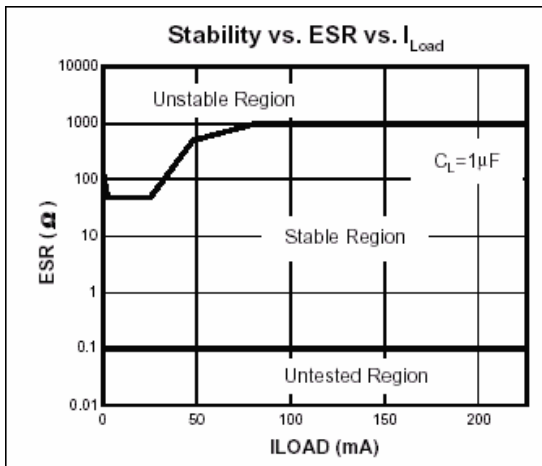

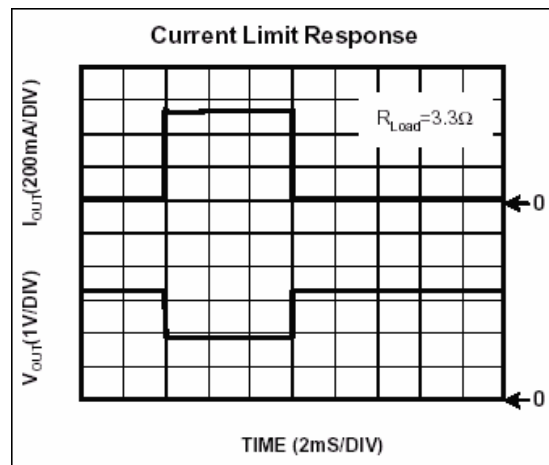
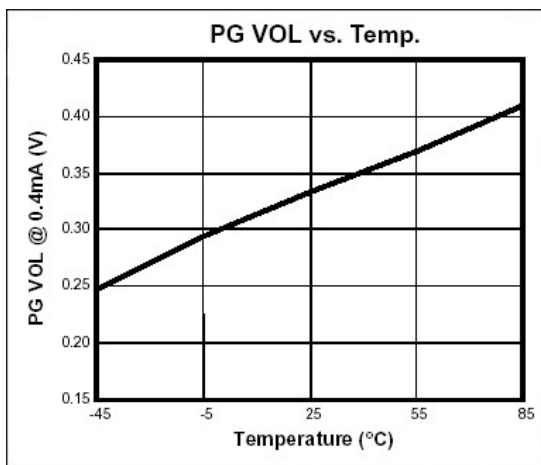
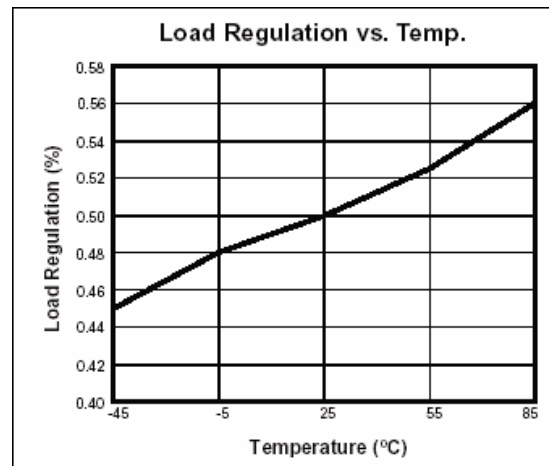
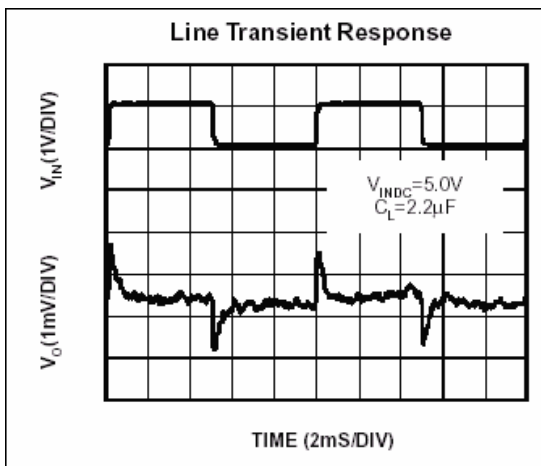
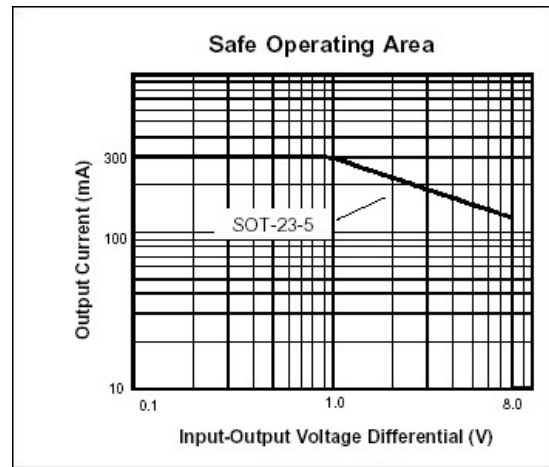
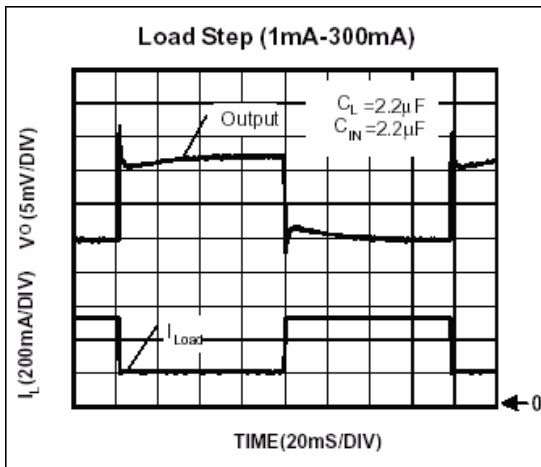

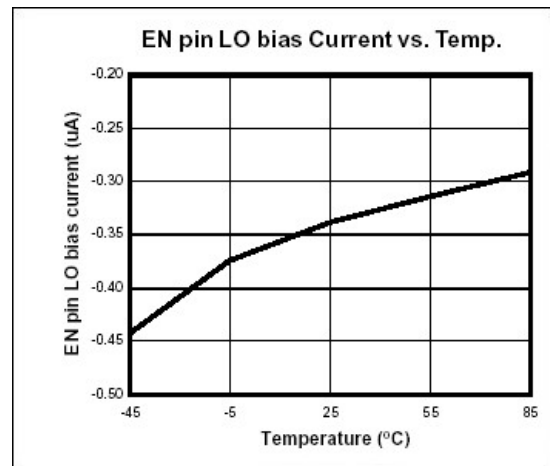
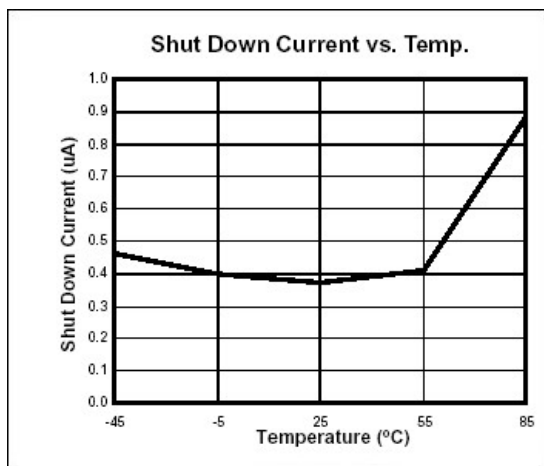
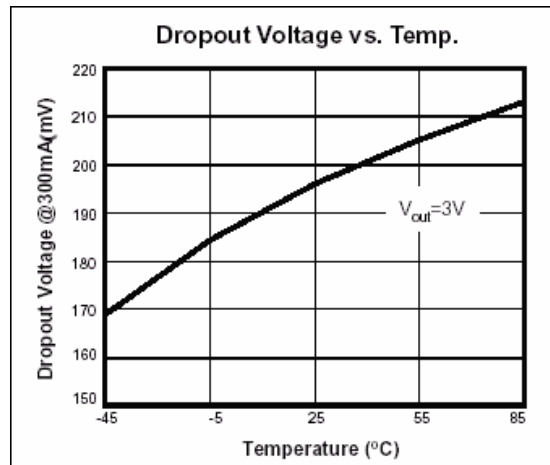
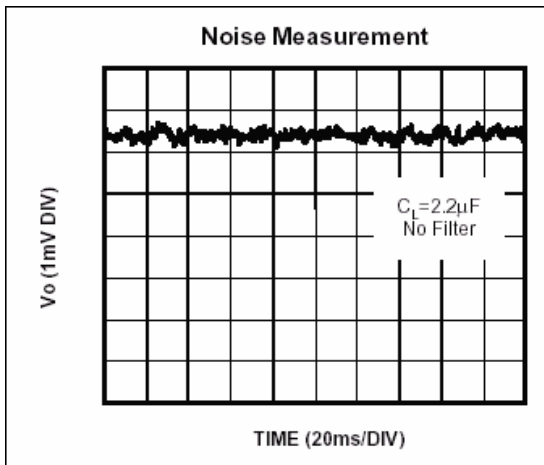
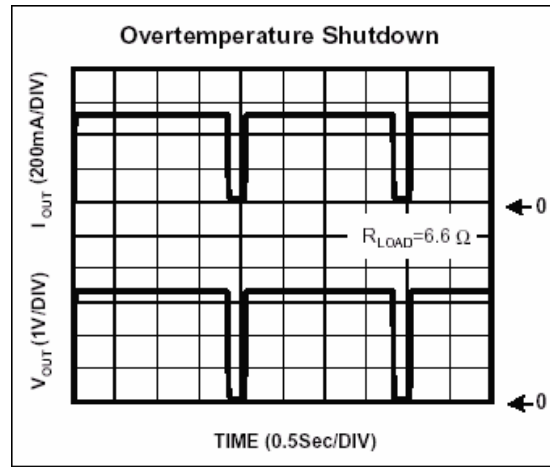
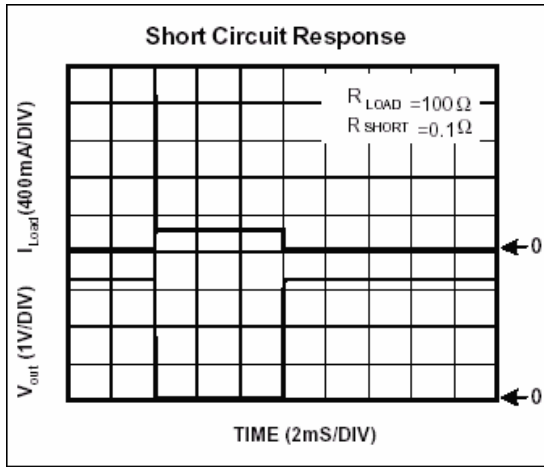

Detailed Description

The GQ2133 series of COMS regulators contain a PMOS pass transistor, voltage reference, error amplifier, over-current protection, and thermal shutdown, and power good function.

The P-channel pass transistor receives data from the error amplifier, over-current shutdown, and thermal protection circuits. During normal operation, the error amplifier compares the output voltage to a precision reference. Over-current and Thermal shutdown circuits become active when the junction temperature exceeds 150°C, or the current exceeds 300mA. During thermal shutdown, the output voltage remains low. Normal operation is restored when the junction temperature drops below 120°C.

The GQ2133 switches from voltage mode to current mode when the load exceeds the rated output current. This prevents over-stress. The GQ2133 also incorporates current fold-back to reduce power dissipation when the output is short circuited. This feature becomes active when the output drops below 0.8 volts, and reduces the current flow by 65%. Full current is restored when the voltage exceeds 0.8 volts.

External Capacitors

The GQ2133 is stable with an output capacitance to ground of 2.2µF or greater. Ceramic capacitors have the lowest ESR, and will offer the best AC performance. Conversely, Aluminum Electrolytic capacitors exhibit the highest ESR, resulting in the poorest AC response. Unfortunately, large value ceramic capacitors are comparatively expensive. One option is to parallel a 0.1µF ceramic capacitor with a 10µF Aluminum Electrolytic. The benefit is low ESR, high capacitance, and low overall cost.

A second capacitor is recommended between the input and ground to stabilize Vin. The input capacitor should be at least 0.1µF to have a beneficial effect.

All capacitors should be placed in close proximity to the pins. A "Quiet" ground termination is desirable. This can be achieved with a "Star" connection.

Enable

The Enable pin normally floats high. When actively, pulled low, the PMOS pass transistor shuts off, and all internal circuits are powered down. In this state, the quiescent current is less than 1µA. This pin behaves much like an electronic switch.

Power Good

The GQ2133 includes the Power Good feature. When the output is not within ±15% of the specified voltage, it pulls low. This can occur under the following conditions:

- 1) Input Voltage too low.
- 2) During Over-Temperature.
- 3) During Over-Current.
- 4) If output is pulled up.

(Note: PG pin is an open-drain output.)

Important Notice:

- All rights are reserved. Reproduction in whole or in part is prohibited without the prior written approval of GTM.
- GTM reserves the right to make changes to its products without notice.
- GTM semiconductor products are not warranted to be suitable for use in life-support Applications, or systems.
- GTM assumes no liability for any consequence of customer product design, infringement of patents, or application assistance.

Head Office And Factory:

- **Taiwan:** No. 17-1 Tatung Rd. Fu Kou Hsin-Chu Industrial Park, Hsin-Chu, Taiwan, R. O. C.
- TEL : 886-3-597-7061 FAX : 886-3-597-9220, 597-0785
- **China:** (201203) No.255, Jang-Jiang Tsai-Lueng RD. , Pu-Dung-Hsin District, Shang-Hai City, China
- TEL : 86-21-5895-7671 ~ 4 FAX : 86-21-38950165