

Description

The AH1891 is a miniature micropower Omnipolar Hall effect switch IC with dual outputs specifically designed for portable and battery powered equipment such as cellular phones and portable PCs. To support battery powered equipment the AH1891 has been optimized to operate over the supply range of 1.8V to 3.3V and uses a sleep function to give an average supply current of only 7uA. To minimize PCB space the AH1891 is packaged in the small CSP package (0.8mmx0.8mm) and the design integrates the external pull up resistors to simplify the applications circuit.

The outputs of the AH1891 are switched with either a North or South pole of sufficient strength. When the magnetic flux density (**B**) is larger than operate point (**Bop**), Output 1 will pull low and Output 2 will be inverted (high). The output states are held until **B** is lower than release point (**Brp**).

The AH1891 is available in U-WLB0808-4 package.

Features

- Omnipolar (North or South) operation
- Low supply voltage of 1.8V to 3.3V
- Micropower operation
- Dual outputs for design flexibility
- Internal pull up and pull down capability
- Chopper stabilized design for:
 - Superior temperature stability
 - Superior temperature stability
 - Superior temperature stability
- Good RF noise immunity
- -40°C to 85°C Operating Temperature
- ESD > 4KV in Human Body Mode
- Miniature CSP package 0.8mm x 0.8mm

Pin Assignments

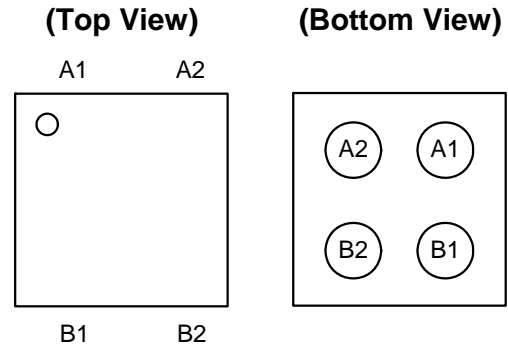

Applications

- Cellular phones
- Portable PCs and PDAs
- Digital cameras
- Portable and battery powered applications

Typical Application Circuit

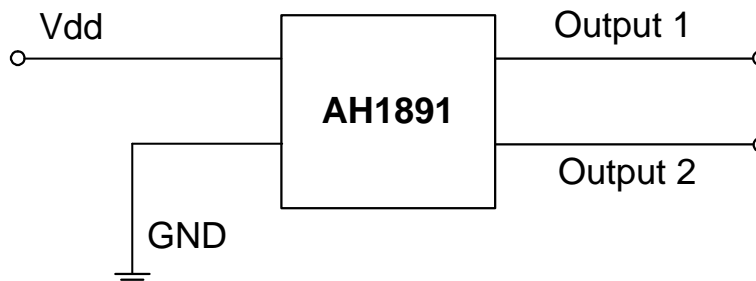

Pin Descriptions

Pin #	Pin Name	Description
A1	Out 1	Output Pin (active low)
A2	Out 2	Output Pin (active high)
B1	GND	Ground
B2	Vdd	Power Supply Voltage

Functional Block Diagram

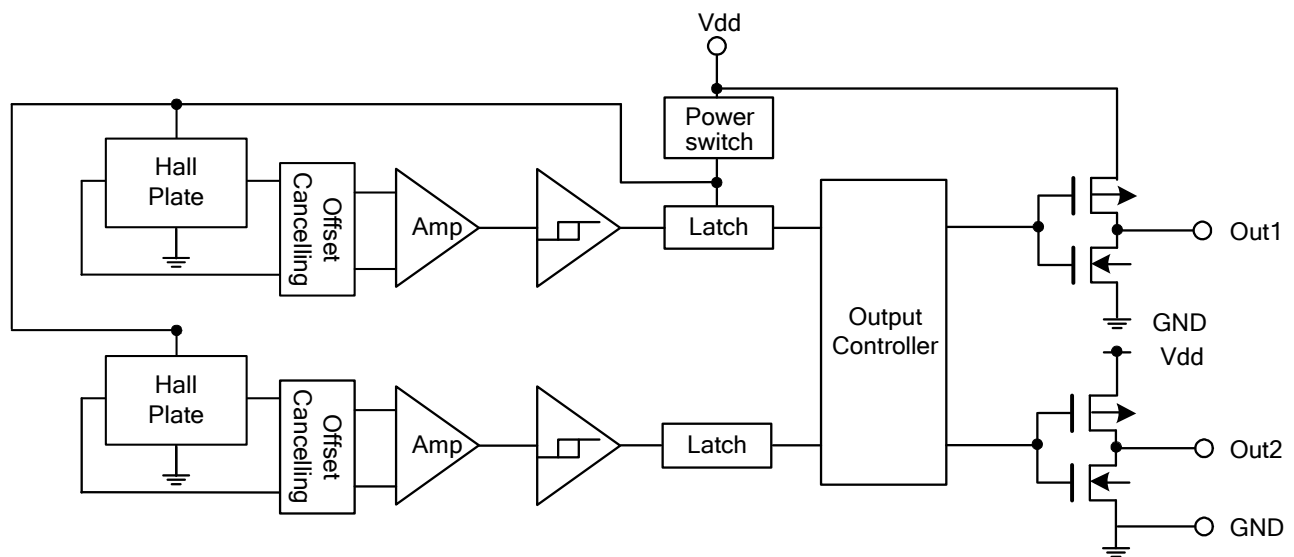

Absolute Maximum Ratings ($T_A = 25^\circ\text{C}$)

Symbol	Parameter	Values	Unit
Vdd	Supply voltage	5	V
B	Magnetic flux density	Unlimited	
T_A	Operating Temperature Range	-40 to +85	$^\circ\text{C}$
T_S	Storage Temperature Range	-65 to +150	$^\circ\text{C}$
P_D	Package Power Dissipation	166	mW
T_J	Maximum Junction Temperature	150	$^\circ\text{C}$

Recommended Operating Conditions ($T_A = 25^\circ\text{C}$)

Symbol	Parameter	Conditions	Rating	Unit
Vdd	Supply Voltage	Operating	1.8 to 3.3	V

Electrical Characteristics ($T_A = 25^\circ\text{C}$, $V_{dd} = 1.8\text{V}$, unless otherwise specified)

Symbol	Parameter	Conditions	Min	Typ.	Max	Unit
V_{OH}	Output On Voltage (High side)	$I_O = -0.5\text{mA}$	$V_{dd}-0.2$	-	-	V
V_{OL}	Output On Voltage (Low side)	$I_O = 0.5\text{mA}$	-	-	0.2	V
I_{off}	Output Leakage Current	Output off	-	<0.1	1	μA
$I_{dd(en)}$	Supply Current	Chip enable	-	2	4	mA
$I_{dd(dis)}$		Chip disable	-	5	8	μA
$I_{dd(avg)}$		Average supply current	-	7	12	μA
T_{awake}	Awake Time		-	50	100	μs
T_{period}	Period		-	50	100	ms
D.C.	Duty Cycle		-	0.1	-	%

Magnetic Characteristics ($T_A = 25^\circ\text{C}$, $V_{dd} = 1.8\text{V}\sim 3.3\text{V}$, Note 1)

(1mT=10 Gauss)

Symbol	Parameter (Note 2)	Min	Typ.	Max	Unit
Bops(south pole to brand side)	Operate Point	20	40	60	Gauss
Bopn(north pole to brand side)		-60	-40	-20	
Brps(south pole to brand side)	Release Point	12	25	50	
Brpn(north pole to brand side)		-50	-25	-12	
$B_{hy}(B_{opx} - B_{rpx})$	Hysteresis		15		

- Notes: 1. Typical data is at $T_A = 25^\circ\text{C}$, $V_{dd} = 3\text{V}$, and for design information only.
 2. Operate point and release point will vary with supply voltage and operating temperature.

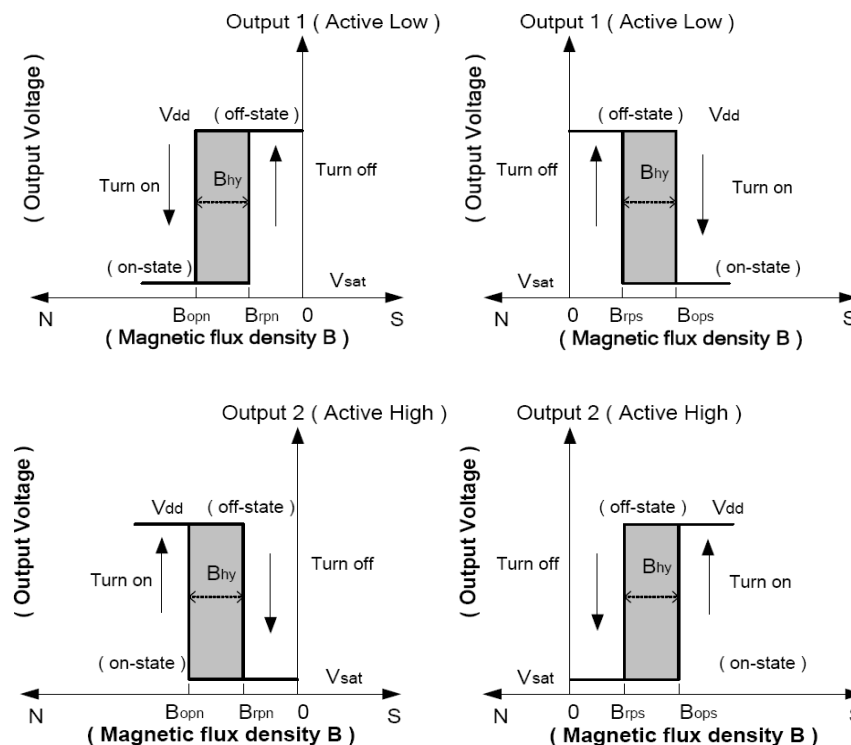

Typical Operating Characteristics

Switch Points Bop and Brp vs. Temperature

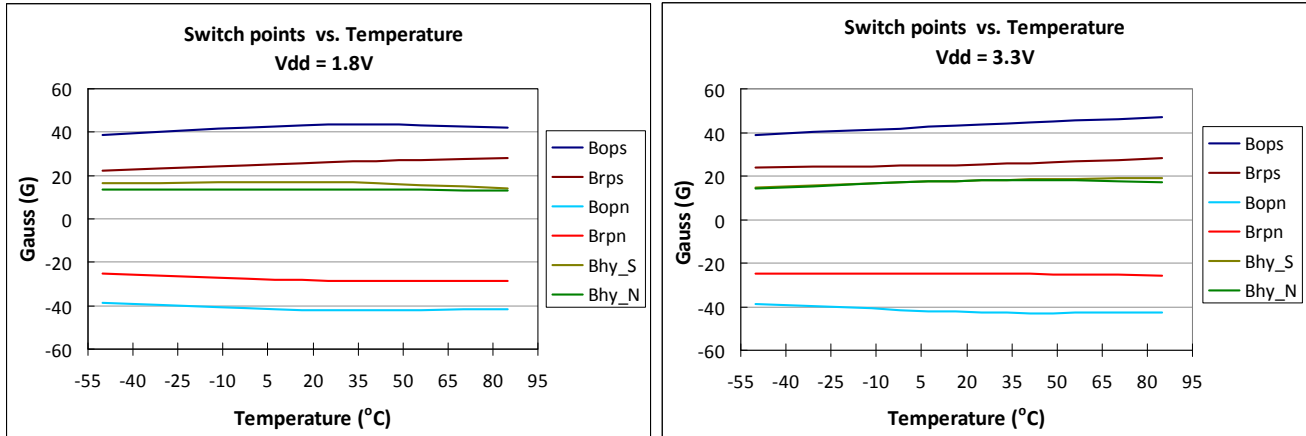

Switch Points Bop and Brp vs. Supply Voltage

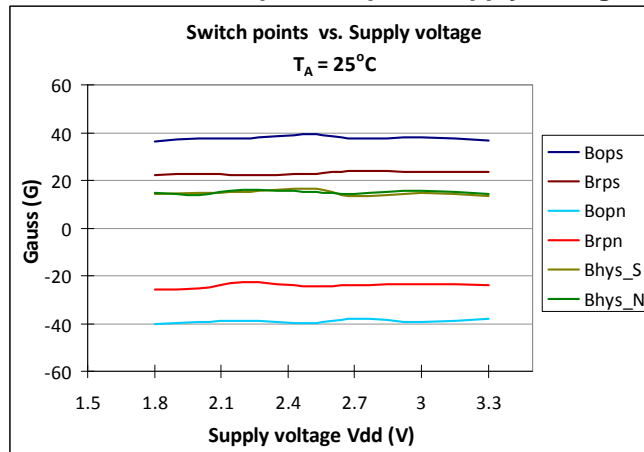

Average Supply Current vs. Temperature

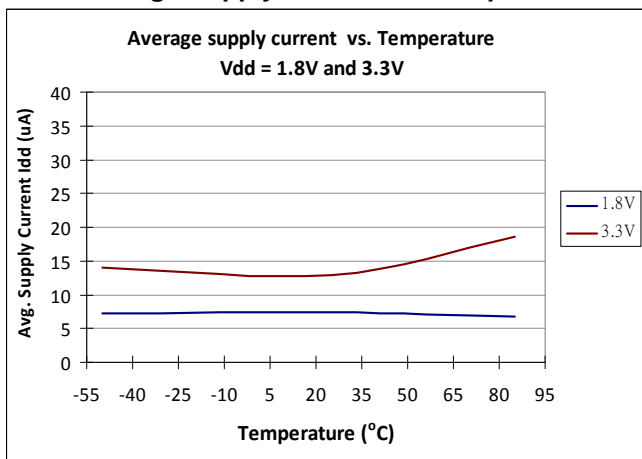

Average Supply Current vs. Supply Voltage

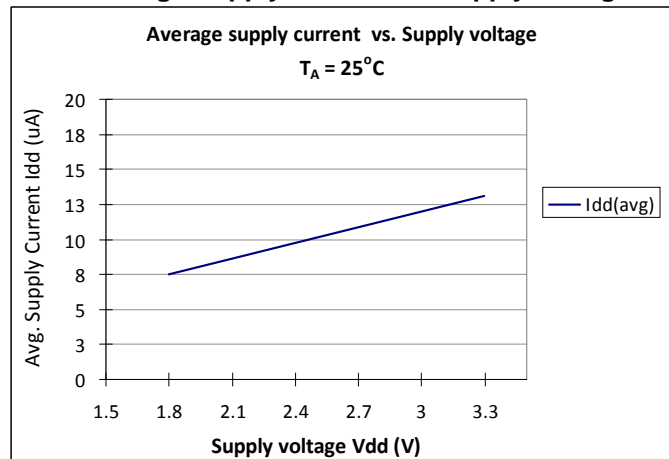

Performance Characteristics

(1) U-WLB0808-4

T _A (°C)	25	50	60	70	80	85	90	100	110	120	130	140	150
P _D (mW)	166	132	120	105	93	86	79	66	53	39	26	13	0

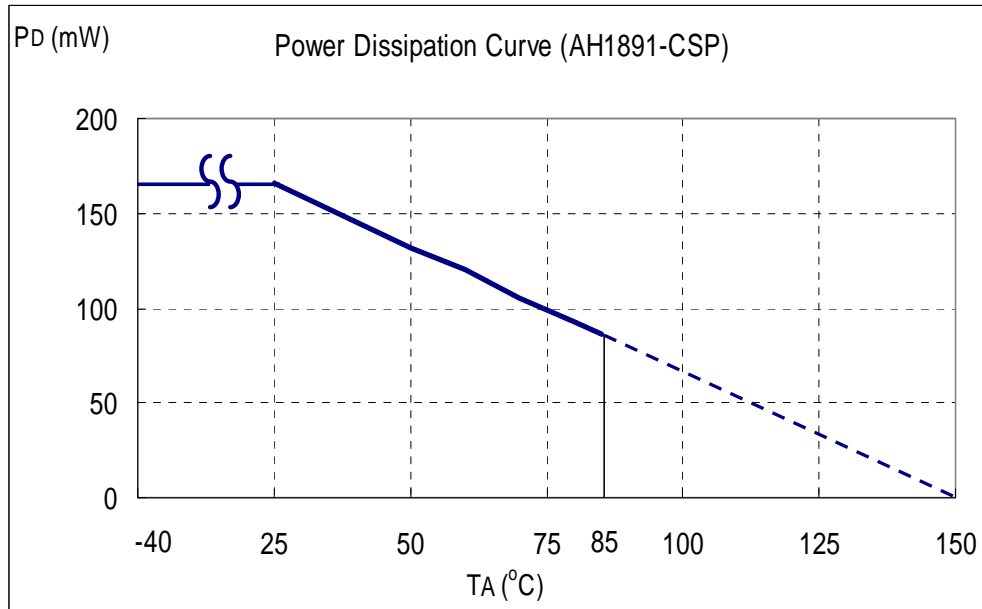

Ordering Information

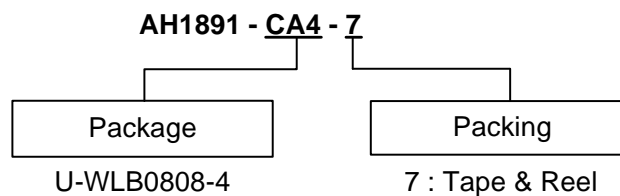

Device (Note 3)	Package Code	Packaging (Note 4)	7" Tape and Reel	
			Quantity	Part Number Suffix
AH1891-CA4-7	CA4	U-WLB0808-4	3000/Tape & Reel	-7



Notes: 3. EU Directive 2002/95/EC (RoHS). All applicable RoHS exemptions applied. Please visit our website at http://www.diodes.com/products/lead_free.html.
 4. Pad layout as shown on Diodes Inc. suggested pad layout document AP02001, which can be found on our website at <http://www.diodes.com/datasheets/ap02001.pdf>.

Marking Information

(1) U-WLB0808-4

(Top View)

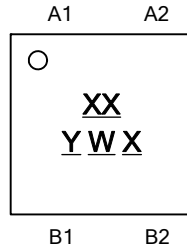

XX : Identification Code
Y : Year : 0~9
W : Week : A~Z : 1~26 week;
 a~z : 27~52 week; z represents
 52 and 53 week
X : A~Z : Internal Code

Part Number	Package	Identification Code
AH1891-CA4-7	U-WLB0808-4	A2

Package Outline Dimensions (All Dimensions in mm)

(1) Package type: U-WLB0808-4

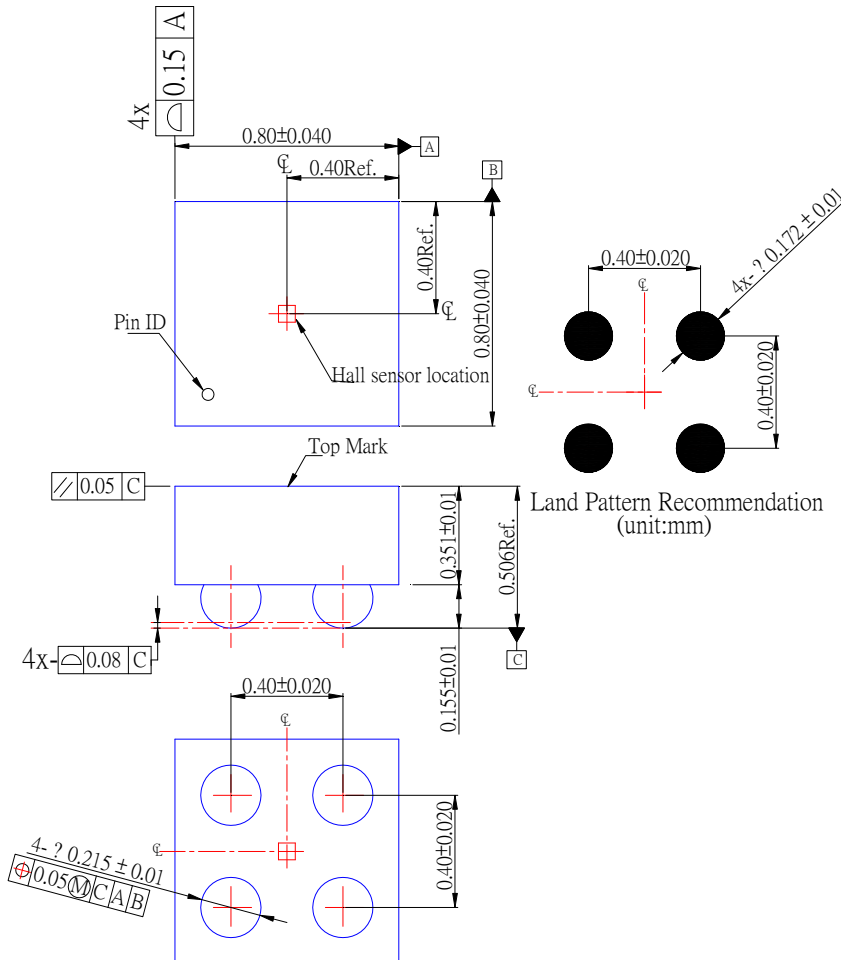

NEW PRODUCT

IMPORTANT NOTICE

DIODES INCORPORATED MAKES NO WARRANTY OF ANY KIND, EXPRESS OR IMPLIED, WITH REGARDS TO THIS DOCUMENT, INCLUDING, BUT NOT LIMITED TO, THE IMPLIED WARRANTIES OF MERCHANTABILITY AND FITNESS FOR A PARTICULAR PURPOSE (AND THEIR EQUIVALENTS UNDER THE LAWS OF ANY JURISDICTION).

Diodes Incorporated and its subsidiaries reserve the right to make modifications, enhancements, improvements, corrections or other changes without further notice to this document and any product described herein. Diodes Incorporated does not assume any liability arising out of the application or use of this document or any product described herein; neither does Diodes Incorporated convey any license under its patent or trademark rights, nor the rights of others. Any Customer or user of this document or products described herein in such applications shall assume all risks of such use and will agree to hold Diodes Incorporated and all the companies whose products are represented on Diodes Incorporated website, harmless against all damages.

Diodes Incorporated does not warrant or accept any liability whatsoever in respect of any products purchased through unauthorized sales channel.

Should Customers purchase or use Diodes Incorporated products for any unintended or unauthorized application, Customers shall indemnify and hold Diodes Incorporated and its representatives harmless against all claims, damages, expenses, and attorney fees arising out of, directly or indirectly, any claim of personal injury or death associated with such unintended or unauthorized application.

Products described herein may be covered by one or more United States, international or foreign patents pending. Product names and markings noted herein may also be covered by one or more United States, international or foreign trademarks.

LIFE SUPPORT

Diodes Incorporated products are specifically not authorized for use as critical components in life support devices or systems without the express written approval of the Chief Executive Officer of Diodes Incorporated. As used herein:

- A. Life support devices or systems are devices or systems which:
1. are intended to implant into the body, or
 2. support or sustain life and whose failure to perform when properly used in accordance with instructions for use provided in the labeling can be reasonably expected to result in significant injury to the user.
- B. A critical component is any component in a life support device or system whose failure to perform can be reasonably expected to cause the failure of the life support device or to affect its safety or effectiveness.

Customers represent that they have all necessary expertise in the safety and regulatory ramifications of their life support devices or systems, and acknowledge and agree that they are solely responsible for all legal, regulatory and safety-related requirements concerning their products and any use of Diodes Incorporated products in such safety-critical, life support devices or systems, notwithstanding any devices- or systems-related information or support that may be provided by Diodes Incorporated. Further, Customers must fully indemnify Diodes Incorporated and its representatives against any damages arising out of the use of Diodes Incorporated products in such safety-critical, life support devices or systems.

Copyright © 2011, Diodes Incorporated

www.diodes.com