

FAN5601

Regulated Step-Down Charge Pump DC/DC Converter

Features

- > 85% Peak Efficiency
- Low EMI
- Low Ripple
- Output Voltage 1.3V/1.8V
- Input Voltage Range: 2.2V to 5.5V
- Output Current: Up to 250mA
- $\pm 2.5\%$ Output Voltage Accuracy
- 30 μ A Operating Current
- $I_{CC} < 1\mu$ A in Shutdown Mode
- 2MHz Operating Frequency
- Shutdown Isolates Output from Input
- Soft-Start Limits Inrush Current
- Short Circuit and Over Temperature Protection
- Minimum External Component Count
- 6-Lead 3x3mm MLP Package

Applications

- Cell Phones
- Handheld Computers
- Portable Electronic Equipment
- Core Supply to Next Generation Processors
- Low Voltage DC Bus
- Digital Cameras
- DSP Supplies

Description

The FAN5601 is an advanced third generation switched capacitor step down DC/DC converter utilizing Fairchild's proprietary ScalarPump™ technology. This innovative architecture utilizes scalar switch re-configuration and fractional switching techniques to produce low output ripple, low ESR spikes and improve efficiency over a wide load range.

The FAN5601 produces a fixed regulated output from 2.2V to 5V input voltage. Customized output voltages are available in 100mV increments from 1V to 1.8V. Contact marketing for customized outputs.

In order to maximize efficiency, the FAN5601 achieves regulation by skipping pulses. Depending upon load current, the size of the switches is scaled dynamically, consequently, current spikes and EMI are minimized. An internal soft start circuitry prevents excessive current drawn from the supply. The device is internally protected against short circuit and over temperature conditions.

The FAN5601 is available in 6-lead 3x3mm MLP.

ScalarPump™ is a registered trademark of Fairchild Semiconductor Corporation.

Typical Application

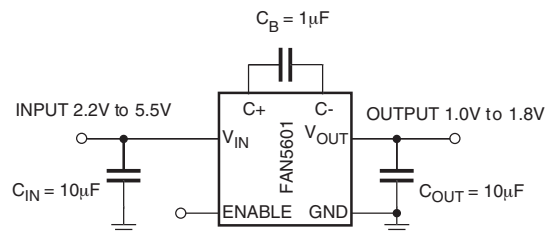

Pin Assignment

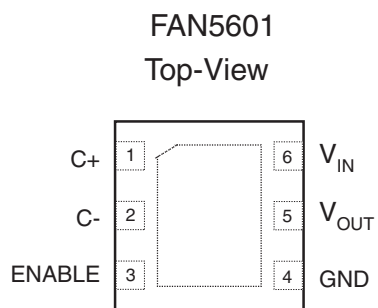

Pin Description

Pin No.	Pin Name	Pin Function Description
	6-Lead 3x3mm MLP	
1	C+	Bucket Capacitor Positive Connection
2	C-	Bucket Capacitor Negative Connection
3	ENABLE	Enable Pin
4	GND	No Connection
5	V _{OUT}	No Connection
6	V _{IN}	Ground

Absolute Maximum Ratings (Note1)

Parameter	Min	Max	Unit
$V_{IN}, V_{OUT}, \text{ENABLE to GND}$	-0.3	6.0	V
C+, C-, to GND	-0.3	$V_{IN} + 0.3$	V
V_{OUT} Short Circuit Duration		INDEFINITE	
Lead Soldering Temperature (10 seconds)		300	°C
Operating Temperature Range	-40	+85	°C
Junction Temperature		150	°C
Storage Temperature	-55	150	°C
Electrostatic Discharge (ESD) Protection (Note2)	HBM	4	kV
	CDM	1	

Recommended Operating Conditions

Parameter	Package	Min	Typ	Max	Unit
Input Voltage		2.2		5.5	V
Output Current				250	mA
Operating Ambient Temperature		-40		85	°C
Thermal Resistance Junction to Tab	6-lead 3x3mm MLP		8		°C/W
Thermal Resistance Junction to Ambient	6-lead 3x3mm MLP (Note 3)		90		°C/W

Notes:

1. Operation beyond the absolute maximum rating may cause permanent damage to device.
2. Using Mil Std. 883E, method 3015.7(Human Body Model) and EIA/JESD22C101-A (Charge Device Model).
3. One square inch, 1oz bottom side GND plane connected to top side GND plane by field of via.

Electrical Characteristics

$V_{IN} = 2.2V$ to $5.5V$, $I_{OUT} = 1mA$, $C_B = 1\mu F$, $C_{IN} = 10\mu F$, $C_{OUT} = 10\mu F$, $T_A = -40^{\circ}C$ to $+85^{\circ}C$, typical values measured at $T_A = 25^{\circ}C$, unless otherwise noted.

Parameter	Conditions	Min.	Typ.	Max.	Units
Input Undervoltage Lockout		1.9	2.0	2.17	V
Output Voltage			Vnom		V
Output Voltage Accuracy	$T_A = 25^{\circ}C$, $V_{IN} = 3.3V$	-2		+2	%
	$V_{IN} = 3.3V$	-2.5		+2.5	%
Output Voltage Temperature Coefficient	$V_{IN} = 3.3V$		25		ppm
Load Regulation			0.133		mV/mA
Line Regulation	$T_A = 25^{\circ}C$		1.35	2	mV/V
No load Supply Current (Note 4)	$I_{OUT} = 0mA$, $V_{IN} = 2.2V$		30	60	μA
Shutdown Supply Current	ENABLE = GND. $V_{OUT} = 0$		0.1	1	μA
Output Short-circuit Current (Note 5)	$V_{OUT} = GND$.		25		mA
Efficiency	$V_{IN} = 2.35 \times V_{OUT}$ $I_{OUT} = 150mA$		85		%
V_{IN} at Configuration Change	From 2:1 to 1:1 mode		2.22 x Vnom		V
Oscillator Frequency			2.0		MHz
Thermal Shutdown Threshold			150		$^{\circ}C$
Thermal Shutdown Threshold Hysteresis			15		$^{\circ}C$
ENABLE Logic Input High Voltage, V_{IH}	$V_{IN} = 2.2V$ to $5.5V$	1.3			V
ENABLE Logic Input Low Voltage, V_{IL}	$V_{IN} = 2.2V$ to $5.5V$			0.4	V
ENABLE Logic Input Current	ENABLE = V_{IN} or GND	-1		1	μA
V_{OUT} Turn On Time	$V_{IN} = 3.6V$, $I_{OUT} = 0mA$, 10% to 90%		1		mS

Notes:

- No load supply current is measured when the oscillator is off.
- The short circuit protection is designed to protect against pre-existing short circuit conditions, i.e. assembly shorts that exist prior to device power-up. The short circuit current limit is $25mA_{Average}$. Short circuit currents in normal operation are inherently limited by the ON-resistance of internal device. Since this resistance is in the range of 1Ω , in some cases thermal shutdown may occur. However, immediately following the first thermal shutdown event, the short circuit condition will be treated as pre-existing, and the load current will reduce to $25mA_{Average}$.

Typical Performance Characteristics

$T_A = 25^\circ\text{C}$, $C_{IN} = C_{OUT} = 10\mu\text{F}$, $C_B = 1\mu\text{F}$, $V_{OUT} = 1.3\text{V}$, unless otherwise noted.

Line Transient Response

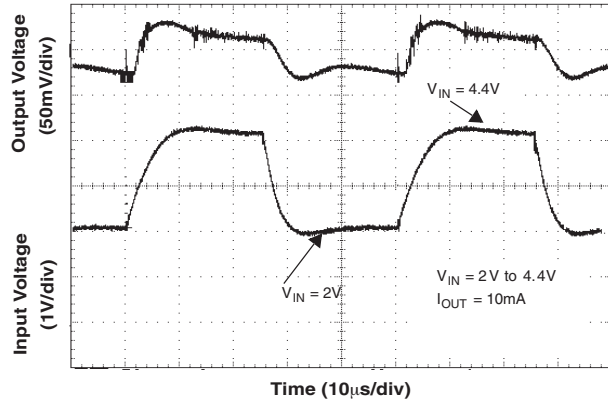

Load Transient Response

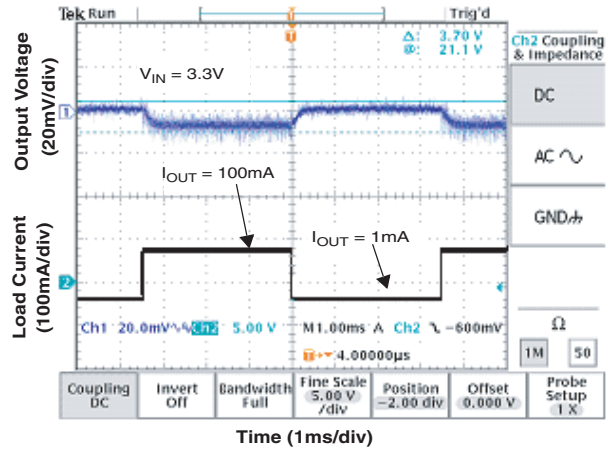

Input Current vs Input Voltage

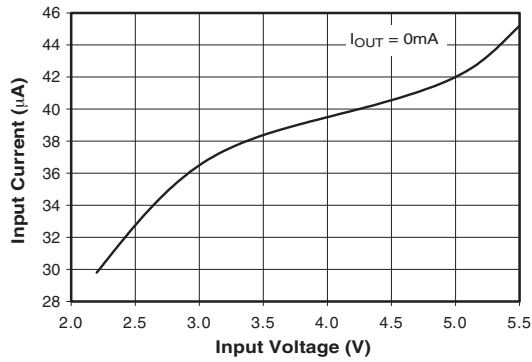

Shutdown Current vs Input Voltage

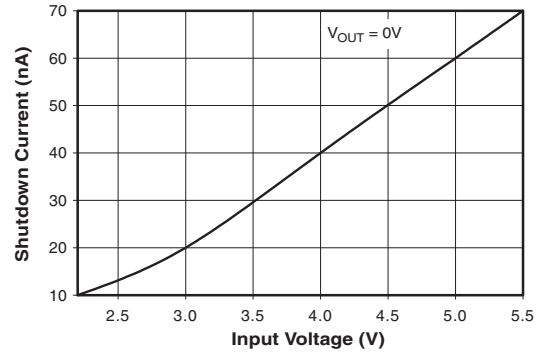

Output Voltage vs Ambient Temperature

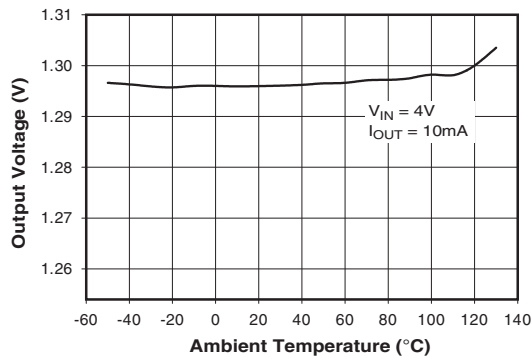

Mode Change Threshold and Hysteresis vs Load Current

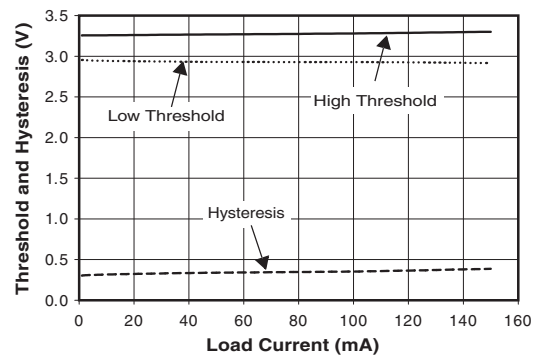

Typical Performance Characteristics (cont.)

$T_A = 25^\circ\text{C}$, $C_{IN} = C_{OUT} = 10\mu\text{F}$, $C_B = 1\mu\text{F}$, $V_{OUT} = 1.3\text{V}$, unless otherwise noted.

Enable Threshold vs Input Voltage

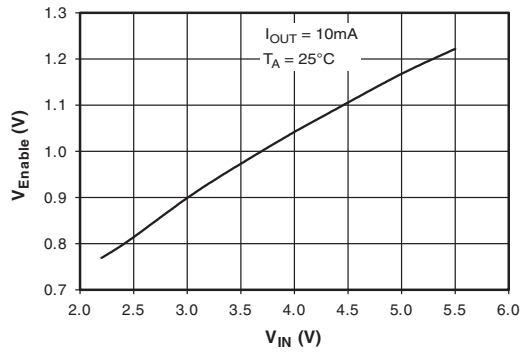

Enable Delay

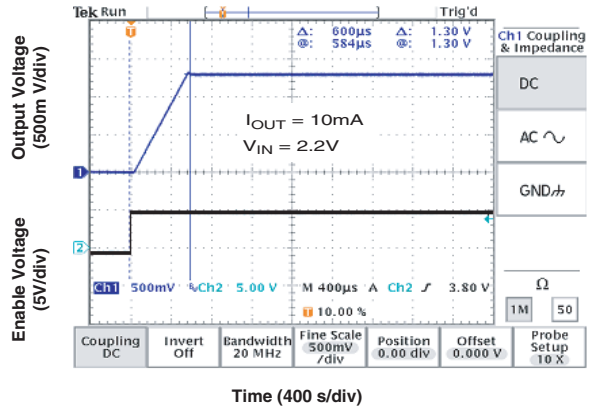

Output Ripple

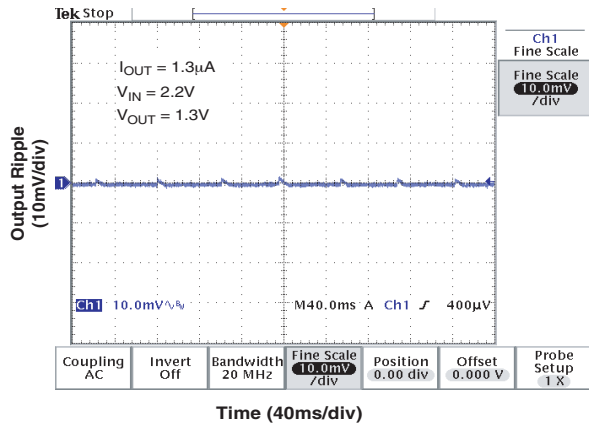

Output Ripple

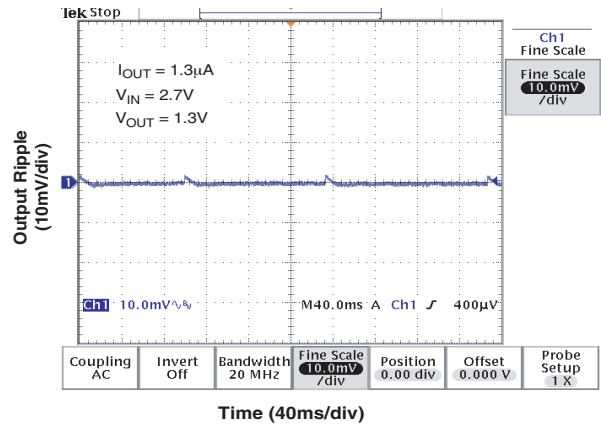

Output Ripple

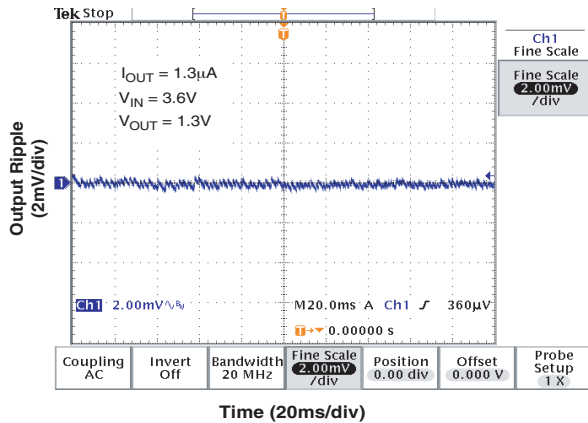

Output Ripple

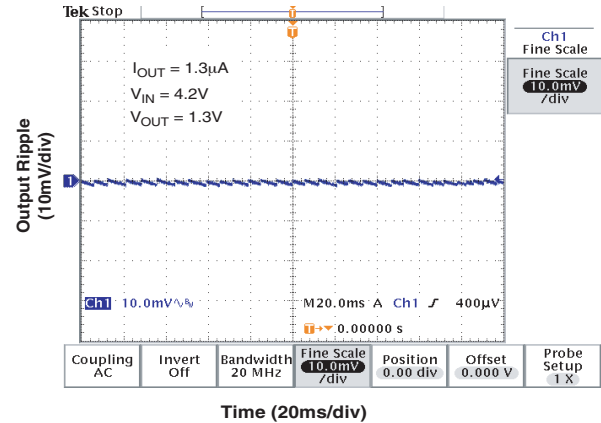

Typical Performance Characteristics (cont.)

$T_A = 25^\circ\text{C}$, $C_{IN} = C_{OUT} = 10\mu\text{F}$, $C_B = 1\mu\text{F}$, $V_{OUT} = 1.3\text{V}$, unless otherwise noted.

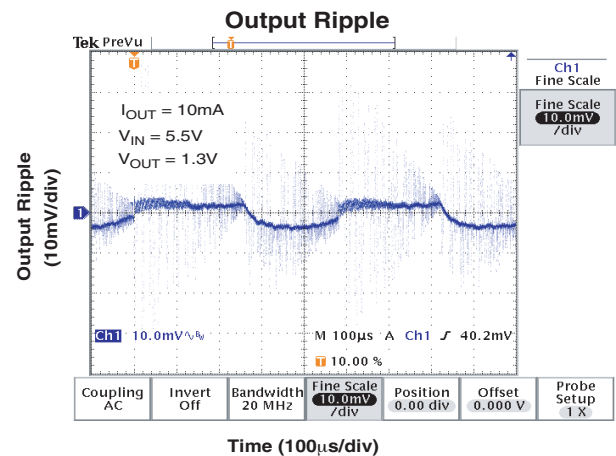
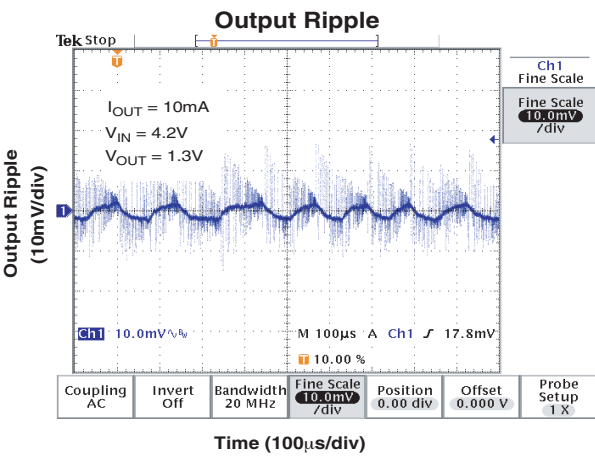
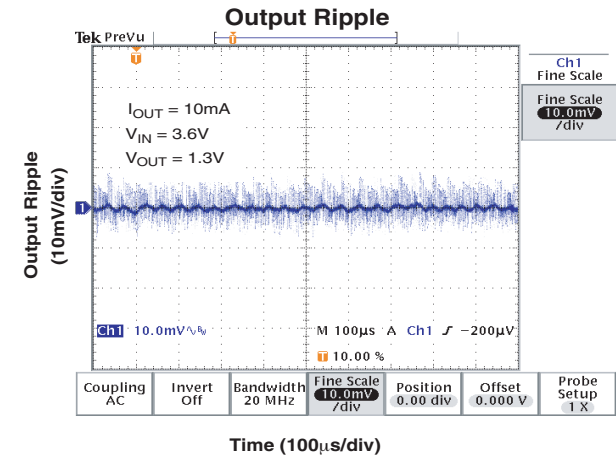
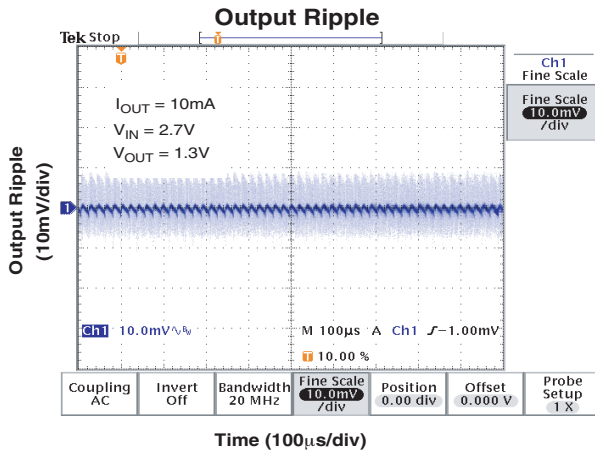
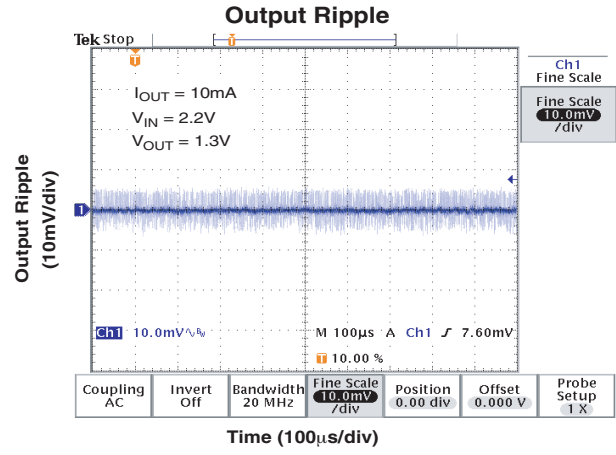
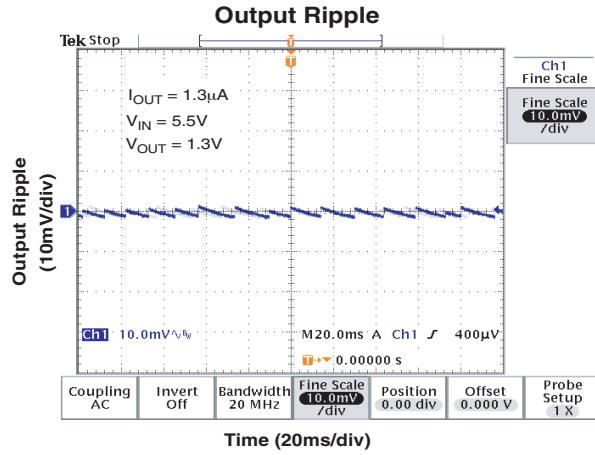

Typical Performance Characteristics (cont.)

$T_A = 25^\circ\text{C}$, $C_{IN} = C_{OUT} = 10\mu\text{F}$, $C_B = 1\mu\text{F}$, $V_{OUT} = 1.3\text{V}$, unless otherwise noted.

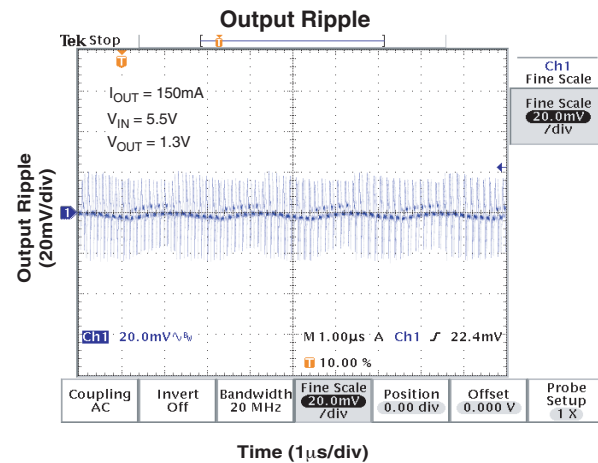
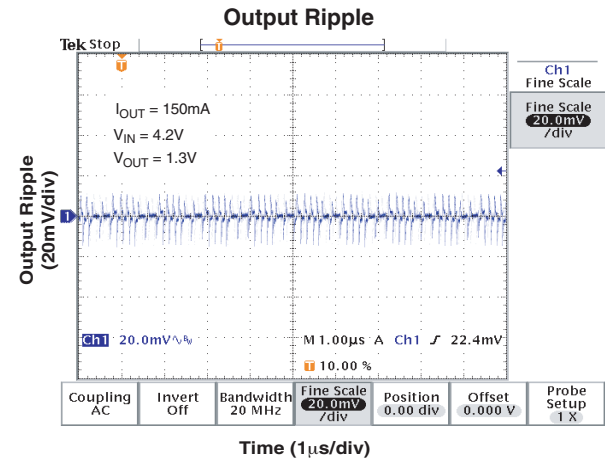
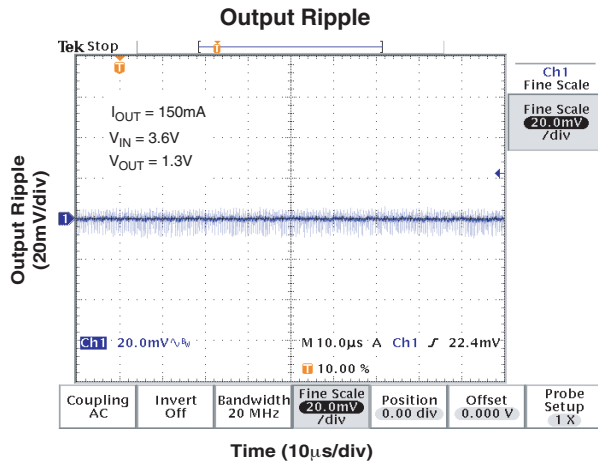
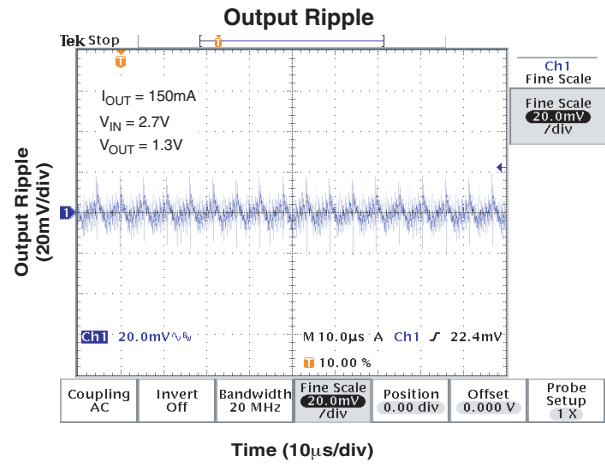
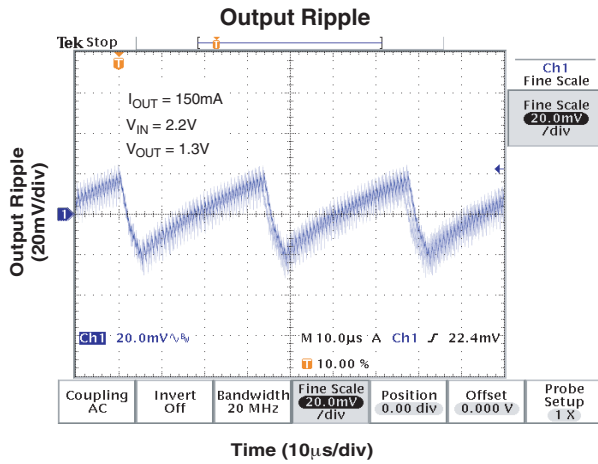

Typical Performance Characteristics (cont.)

$T_A = 25^\circ\text{C}$, $C_{IN} = C_{OUT} = 10\mu\text{F}$, $C_B = 1\mu\text{F}$, $V_{OUT} = 1.3\text{V}$, unless otherwise noted.

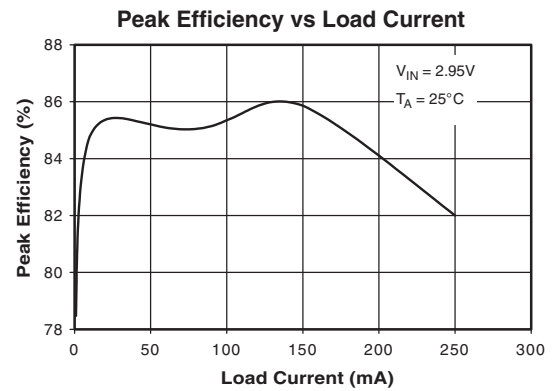
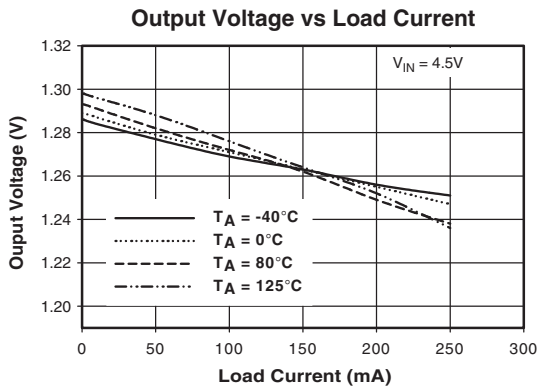
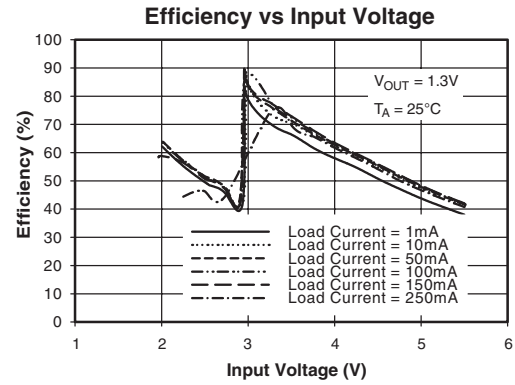
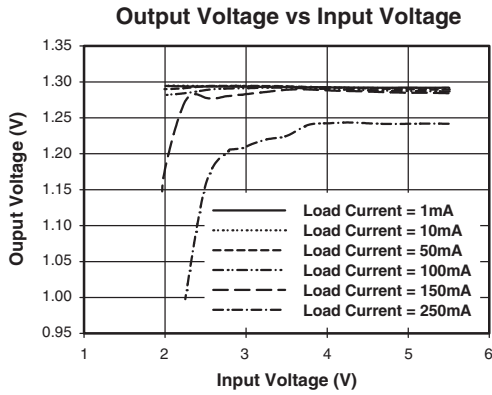

Block Diagram

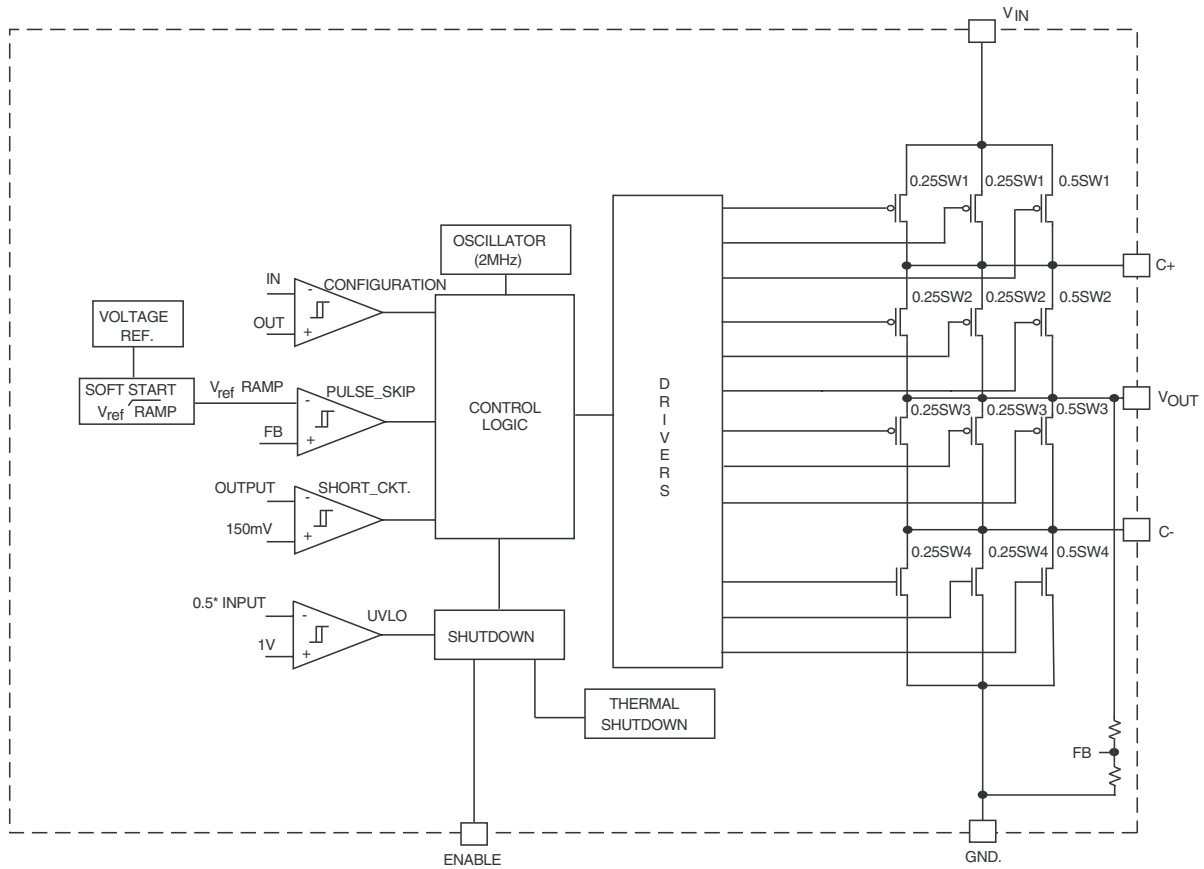

Detailed Description

The FAN5601 switched capacitor DC/DC converter automatically configures switches to achieve a high efficiency and provides a regulated output voltage by means of pulse skipping, pulse frequency modulation (PFM). An internal soft start circuit prevents excessive inrush current drawn from the supply. Each switch is split into three segments. Based on the values of V_{IN} , V_{OUT} and I_{OUT} , an internal circuitry determines the number of segments to be used to reduce current spikes.

Step-Down Charge Pump Operation

When $V_{IN} \geq 2.22 \times V_{OUT}$, a 2:1 configuration shown in Fig.1(A) is enabled. The factor 0.9 is used instead of 1 in order to account for the effect of resistive losses across the switches and to accommodate hysteresis in the voltage detector comparator. Two phase non-overlapping clock signals are generated to drive four switches. When switches 1 and 3 are ON, switches 2 and 4 are OFF and C_B is charged. When switches 2 and 4 are ON, switches 1 and 3 are OFF, charge is transferred from C_B to C_{OUT} .

When $V_{IN} < 2.22 \times V_{OUT}$, a 1:1 configuration shown in Fig. 1(B) is enabled. In the 1:1 configuration switch 3 is always OFF and the switch 4 is always ON. At 1.6V output setting the configuration changes from 2:1 to 1:1 at $V_{IN} = 3.56V$. At 1.3V output setting the change occurs at $V_{IN} = 3.06V$

Pulse-skipping PFM and Fractional Switch Operation

When the regulated output voltage reaches its upper limit, the switches are turned off the output voltage reaches its lower limit. Considering a step-down 2:1 mode of operation, 1.6V output as an example, when the output reaches about 1.62V(upper limit), the control logic turns off all switches. Switching stops completely. This is pulse-skipping mode. Since the supply is isolated from the output, the output voltage will drop. Once the output is dropped to about 1.58V(lower limit), the device will return to regular switching mode with one quarter of each switch turning on first. Another quarter of each switch will be turned on if V_{OUT} cannot reach regulation by the time of arrival of the third

Switch Configuration

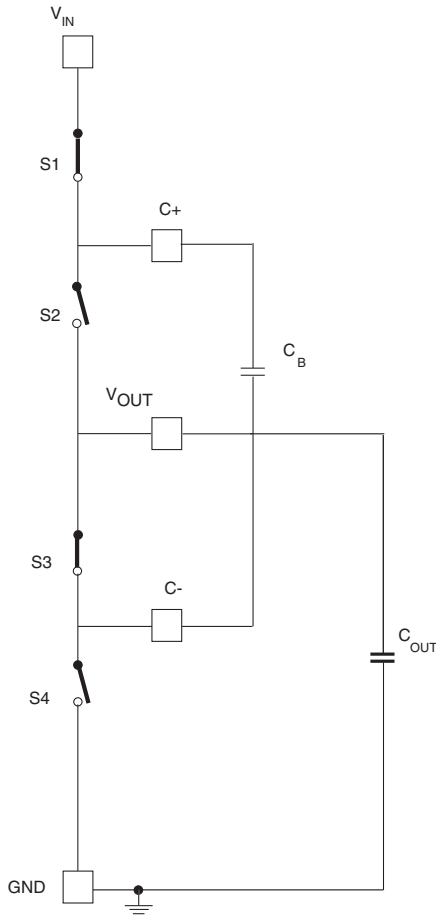

Figure 1. (A)

2:1 configuration
Switches in charging phase
Reverse all switches for pumping phase

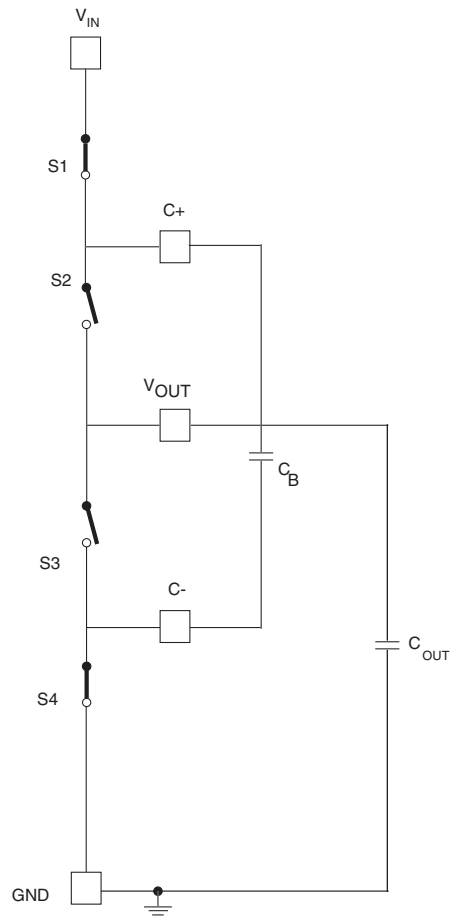

Figure 1. (B)

1:1 configuration
Switch 3 is always off and
Switch 4 is always on
Switches 1 and 2 are in phase 1
Reverse the position of switches 1&2
for phase 2

charge cycle. Full switch operation occurs only during start-up or under heavy load condition, when half switch operation cannot achieve regulation within seven charge cycles.

Soft Start

The soft-start feature limits inrush current when the device is initially powered up and enabled. The reference voltage is used to control the rate of the output voltage ramp-up to its final value. Typical start-up time is 1ms. Since the rate of the output voltage ramp-up is controlled by an internally generated slow ramp, pulse-skipping occurs and inrush current is automatically limited.

Shutdown, UVLO, Short Circuit Current Limit and Thermal Shutdown

The device has an active-low shutdown pin to decrease supply current to less than $1\mu\text{A}$. In shutdown mode the supply is disconnected from the output. UVLO triggers when supply voltage drops below 2V. When the output voltage is lower than 150mV, a short circuit protection is triggered. In this mode 15 out of 16 pulses during the switching will be skipped and the supply current is limited. Thermal shutdown triggers at 150°C .

Applications Information

Proper operation of the FAN5601 requires one ceramic bucket capacitor in the 0.1 μ F to 1 μ F range; one 10 μ F output bypass capacitor and one 10 μ F input bypass capacitor. In order to obtain optimum output ripple and noise performance, use of low ESR (<0.05 Ω) ceramic input and output bypass capacitors is recommended. The X5R and X7R rated capacitors provide adequate performance over the -40 $^{\circ}$ C to 85 $^{\circ}$ C temperature range.

The value of the bucket capacitor is dependent on load current requirements. A 1 μ F bucket capacitor will work well in all applications at all load currents, while a 0.1 μ F capacitor will support most applications under 100mA of load current. The choice of bucket capacitor values should be verified in the actual application at the lowest input voltage and highest load current. A 30% margin of safety is recommended in order to account for the tolerance of the bucket capacitor and the variations in the on-resistance of the internal switches.

One of the key benefits of the ScalarPump™ architecture is that the dynamically scaled on-resistance of the switches effectively reduces the peak current in the bucket capacitor and therefore input and output ripple current is also reduced. Nevertheless, due to the ESR of the input and output bypass capacitors, these current spikes generate voltage spikes at the input and output pins. However, these ESR spikes can be easily filtered because their frequency lie at up to 12 times the clock frequency.

In applications where conductive and radiated EMI/RFI interference has to be kept as low as possible, the user may consider the use of additional input and output filtering. For example, adding an L-C filter to the standard output bypass configuration is very effective in reducing both the output ripple and the voltage spikes. Figure 2 shows an L-C filter using a 100nH chip inductor and a 1 μ F capacitor. The channel 1 of Figure 3 shows the ripple at the output of the device while Channel 2 shows the ripple voltage at the output of the filter at $V_{IN} = 3.3V$,

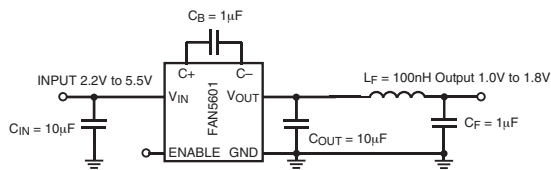

Figure 2. Optional L-C Filter

$V_{OUT} = 1.3V$ and $I_{OUT} = 100mA$. Similar filtering method will greatly reduce the current spikes at the input. The user should be mindful of considering resistive voltage drops in the inductors connected serially in the input and output leads.

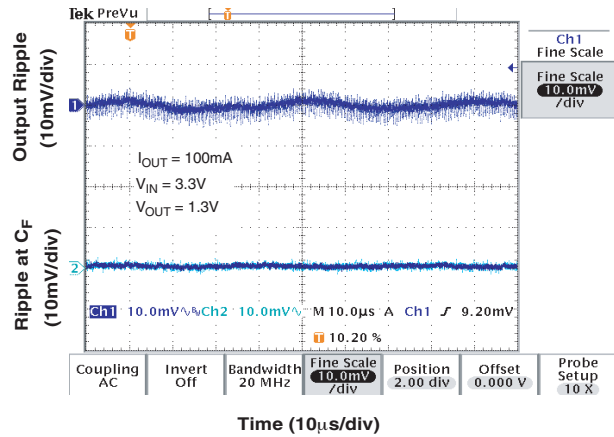

Figure 3. Effect of L-C Filter on output ripple

While evaluating the FAN5601 (or any other switched capacitor DC-DC converter) the user should be careful to keep the power supply source impedance low; use of long wires causing high lead inductances and resistive losses should be avoided. A carefully laid out ground plane is essential because current spikes are generated as the bucket capacitor is charged and discharged. The input and output bypass capacitors should be placed as close to the device pins as possible.

Ordering Information

Product Number	Package Type	Voltage Option [Vnom]	Order Code
FAN5601	6-Lead 3x3mm MLP	1.3V	FAN5601MP13X
	6-Lead 3x3mm MLP	1.8V	FAN5601MP18X

DISCLAIMER

FAIRCHILD SEMICONDUCTOR RESERVES THE RIGHT TO MAKE CHANGES WITHOUT FURTHER NOTICE TO ANY PRODUCTS HEREIN TO IMPROVE RELIABILITY, FUNCTION OR DESIGN. FAIRCHILD DOES NOT ASSUME ANY LIABILITY ARISING OUT OF THE APPLICATION OR USE OF ANY PRODUCT OR CIRCUIT DESCRIBED HEREIN; NEITHER DOES IT CONVEY ANY LICENSE UNDER ITS PATENT RIGHTS, NOR THE RIGHTS OF OTHERS.

LIFE SUPPORT POLICY

FAIRCHILD'S PRODUCTS ARE NOT AUTHORIZED FOR USE AS CRITICAL COMPONENTS IN LIFE SUPPORT DEVICES OR SYSTEMS WITHOUT THE EXPRESS WRITTEN APPROVAL OF THE PRESIDENT OF FAIRCHILD SEMICONDUCTOR CORPORATION. As used herein:

1. Life support devices or systems are devices or systems which, (a) are intended for surgical implant into the body, or (b) support or sustain life, and (c) whose failure to perform when properly used in accordance with instructions for use provided in the labeling, can be reasonably expected to result in a significant injury of the user.
2. A critical component in any component of a life support device or system whose failure to perform can be reasonably expected to cause the failure of the life support device or system, or to affect its safety or effectiveness.