

MiniLED Ultrabright

Description

The new MiniLED Series have been designed in a small white SMT package. The feature of the device is the very small package 2.3 mm x 1.3 mm x 1.4 mm. The MiniLED is an obvious solution for small-scale, high-power products that are expected to work reliably in an arduous environment. This is often the case in automotive and industrial application.

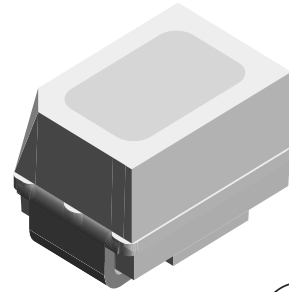

19226



Features

- SMD LEDs with exceptional brightness
- Luminous intensity categorized
- Compatible with automatic placement equipment
- IR reflow soldering
- Available in 8 mm tape
- Low profile package
- Non-diffused lens: Excellent for coupling to light pipes and backlighting
- Low power consumption
- Luminous intensity ratio in one packing unit
 $I_{Vmax}/I_{Vmin} \leq 2.0$, optional ≤ 1.6
- Lead-free device

Applications

Automotive: Backlighting in dashboards and switches
 Telecommunication: Indicator and backlighting in telephone and fax
 Indicator and backlight for audio and video equipment
 Indicator and backlight in office equipment
 Flat backlight for LCDs, switches and symbols

Parts Table

Part	Color, Luminous Intensity	Angle of Half Intensity ($\pm\phi$)	Technology
TLMK2300	Red, $I_V = 80$ mcd (typ.)	60 °	AllnGaP on GaAs
TLMF2300	Orange, $I_V = 120$ mcd (typ.)	60 °	AllnGaP on GaAs
TLME2300	Yellow, $I_V = 120$ mcd (typ.)	60 °	AllnGaP on GaAs

Absolute Maximum Ratings

$T_{amb} = 25$ °C, unless otherwise specified

TLMK230. , TLMF230. , TLME230.

Parameter	Test condition	Symbol	Value	Unit
Reverse voltage		V_R	5	V
DC Forward current	$T_{amb} \leq 80$ °C	I_F	30	mA
Surge forward current	$t_p \leq 10$ μ s	I_{FSM}	0.1	A
Power dissipation	$T_{amb} \leq 80$ °C	P_V	80	mW
Junction temperature		T_j	125	°C
Operating temperature range		T_{amb}	- 40 to + 100	°C

Parameter	Test condition	Symbol	Value	Unit
Storage temperature range		T_{stg}	- 40 to + 100	°C
Soldering temperature	according to IPC 9501	T_{sd}	245	°C
Thermal resistance junction/ambient	mounted on PC board (pad size > 5 mm ²)	R_{thJA}	580	K/W

Optical and Electrical Characteristics

$T_{amb} = 25\text{ °C}$, unless otherwise specified

Red

TLMK230.

Parameter	Test condition	Symbol	Min	Typ.	Max	Unit
Luminous intensity ¹⁾	$I_F = 20\text{ mA}$	I_V	32	80		mcd
Dominant wavelength	$I_F = 20\text{ mA}$	λ_d		630		nm
Peak wavelength	$I_F = 20\text{ mA}$	λ_p		643		nm
Angle of half intensity	$I_F = 20\text{ mA}$	ϕ		± 60		deg
Forward voltage	$I_F = 20\text{ mA}$	V_F		1.9	2.6	V
Reverse voltage	$I_R = 10\text{ }\mu\text{A}$	V_R	5			V
Junction capacitance	$V_R = 0, f = 1\text{ MHz}$	C_j		15		pF

¹⁾ in one Packing Unit $I_{Vmax}/I_{Vmin} \leq 2.0$

Orange

TLMF230.

Parameter	Test condition	Symbol	Min	Typ.	Max	Unit
Luminous intensity ¹⁾	$I_F = 20\text{ mA}$	I_V	50	120		mcd
Dominant wavelength	$I_F = 20\text{ mA}$	λ_d	598	605	611	nm
Peak wavelength	$I_F = 20\text{ mA}$	λ_p		610		nm
Angle of half intensity	$I_F = 20\text{ mA}$	ϕ		± 60		deg
Forward voltage	$I_F = 20\text{ mA}$	V_F		2.0	2.6	V
Reverse voltage	$I_R = 10\text{ }\mu\text{A}$	V_R	5			V
Junction capacitance	$V_R = 0, f = 1\text{ MHz}$	C_j		15		pF

¹⁾ in one Packing Unit $I_{Vmax}/I_{Vmin} \leq 2.0$

Yellow

TLME230.

Parameter	Test condition	Symbol	Min	Typ.	Max	Unit
Luminous intensity ¹⁾	$I_F = 20\text{ mA}$	I_V	50	120		mcd
Dominant wavelength	$I_F = 20\text{ mA}$	λ_d	581	588	594	nm
Peak wavelength	$I_F = 20\text{ mA}$	λ_p		590		nm
Angle of half intensity	$I_F = 20\text{ mA}$	ϕ		± 60		deg
Forward voltage	$I_F = 20\text{ mA}$	V_F		2.0	2.6	V
Reverse voltage	$I_R = 10\text{ }\mu\text{A}$	V_R	5			V
Junction capacitance	$V_R = 0, f = 1\text{ MHz}$	C_j		15		pF

¹⁾ in one Packing Unit $I_{Vmax}/I_{Vmin} \leq 2.0$

Typical Characteristics ($T_{amb} = 25\text{ }^{\circ}\text{C}$ unless otherwise specified)

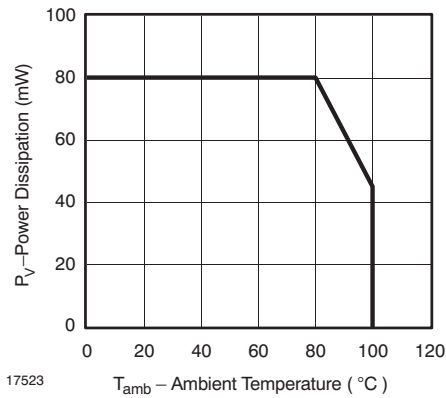

Figure 1. Power Dissipation vs. Ambient Temperature

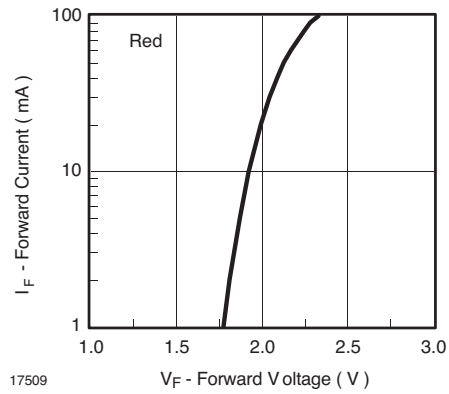

Figure 4. Forward Current vs. Forward Voltage

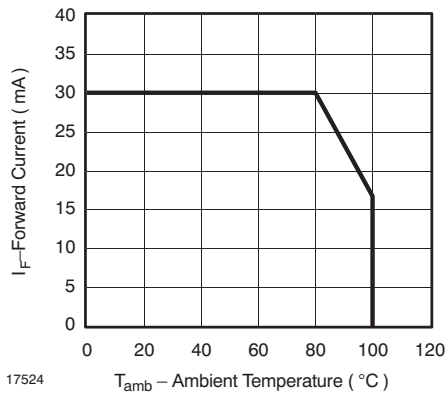

Figure 2. Forward Current vs. Ambient Temperature

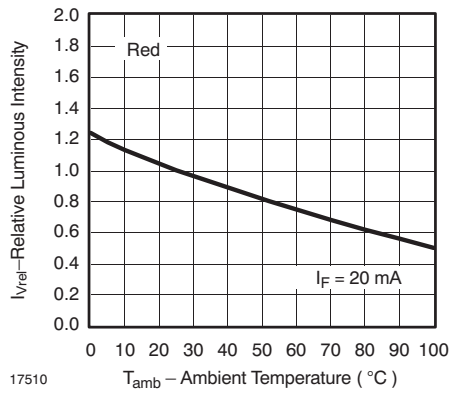

Figure 5. Rel. Luminous Intensity vs. Ambient Temperature

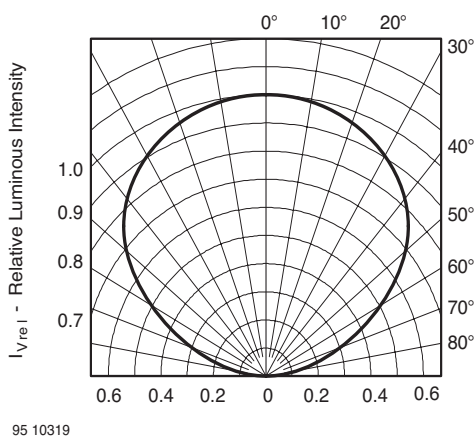

Figure 3. Rel. Luminous Intensity vs. Angular Displacement

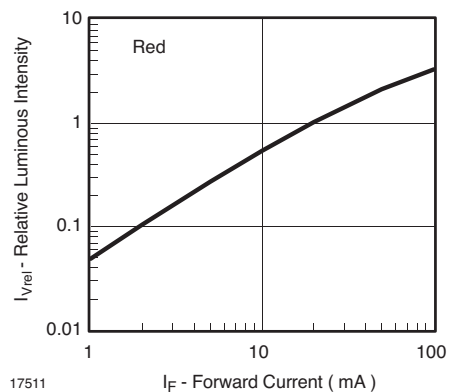

Figure 6. Relative Luminous Intensity vs. Forward Current

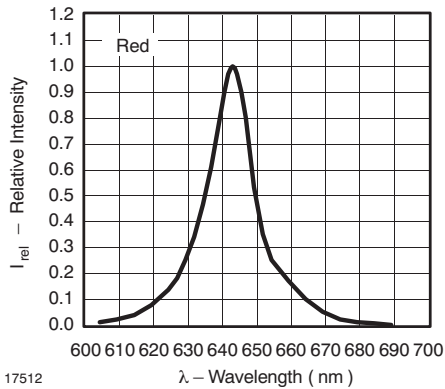

Figure 7. Relative Intensity vs. Wavelength

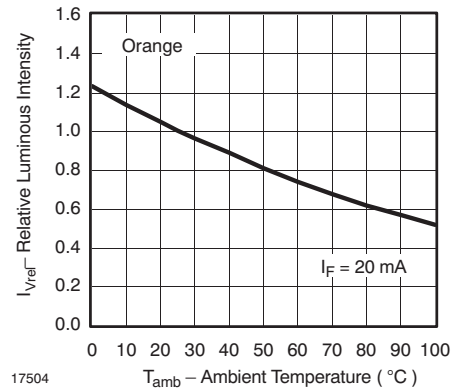

Figure 10. Rel. Luminous Intensity vs. Ambient Temperature

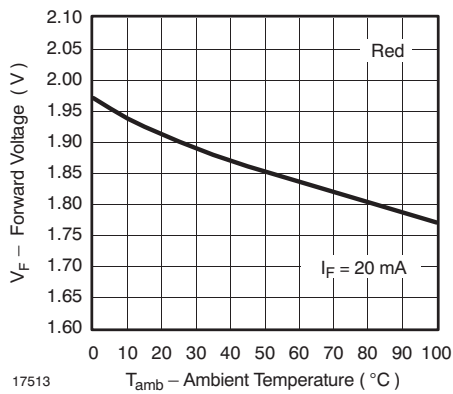

Figure 8. Forward Voltage vs. Ambient Temperature

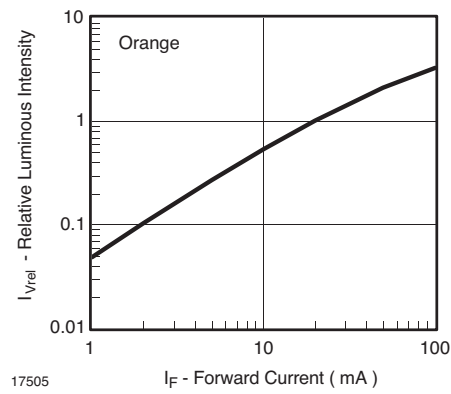

Figure 11. Relative Luminous Intensity vs. Forward Current

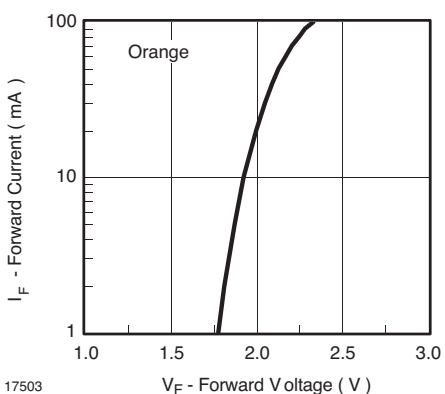

Figure 9. Forward Current vs. Forward Voltage

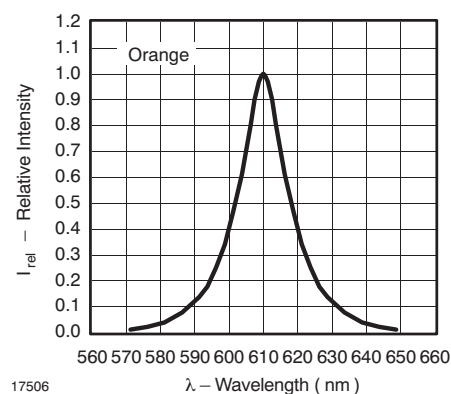

Figure 12. Relative Intensity vs. Wavelength

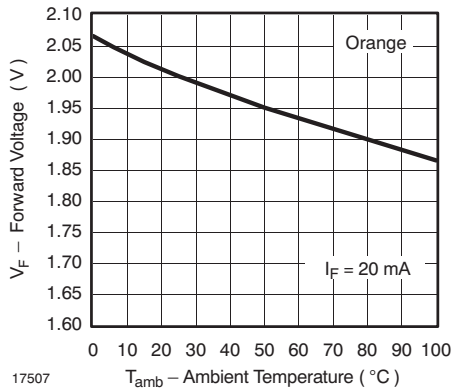

Figure 13. Forward Voltage vs. Ambient Temperature

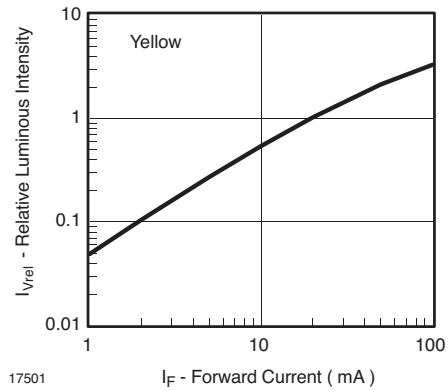

Figure 16. Relative Luminous Intensity vs. Forward Current

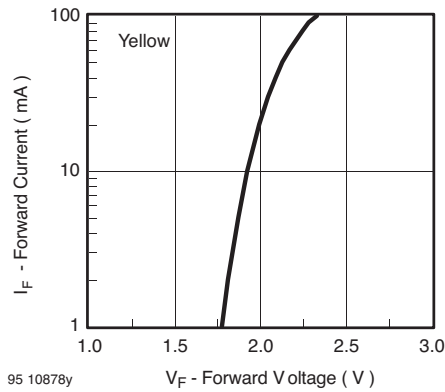

Figure 14. Forward Current vs. Forward Voltage

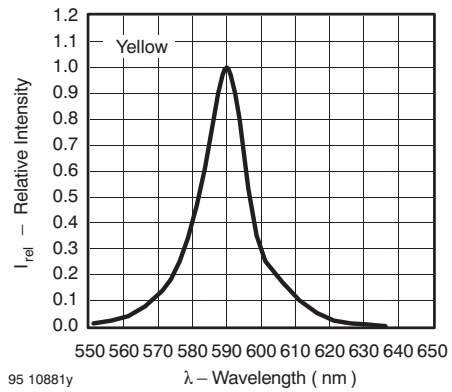

Figure 17. Relative Intensity vs. Wavelength

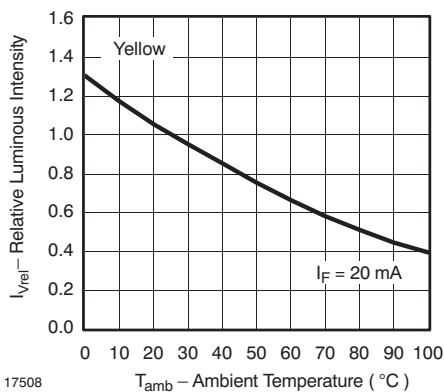

Figure 15. Rel. Luminous Intensity vs. Ambient Temperature

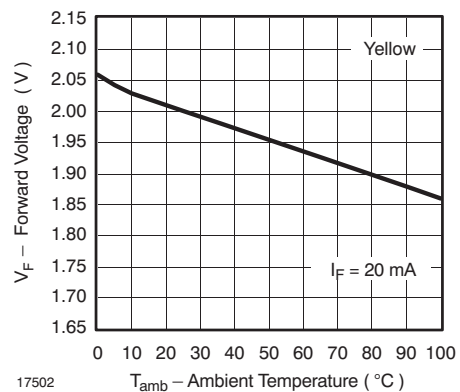
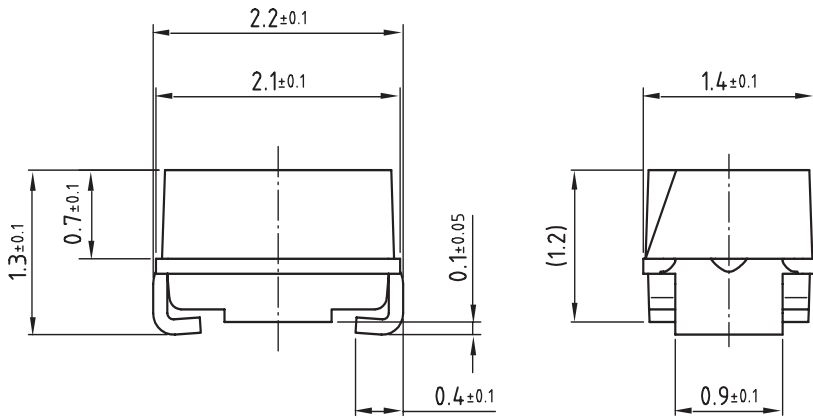

Figure 18. Forward Voltage vs. Ambient Temperature

Package Dimensions in mm



Cathode mark

Not indicated tolerances ± 0.2

All dimensions in mm

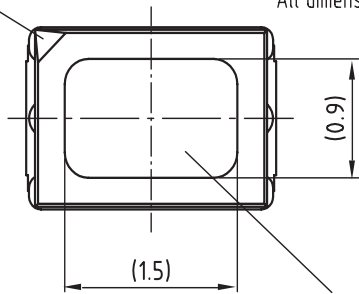

Area not flat

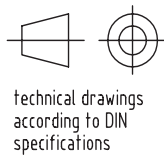
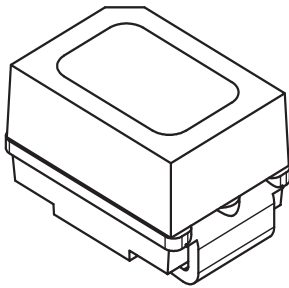

Proposed pad layout
(for reference only)

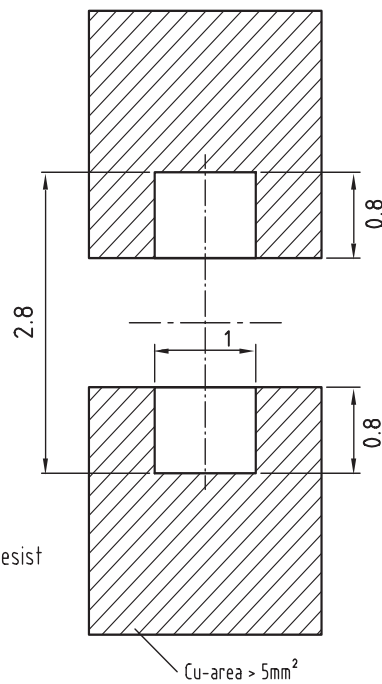

16892

Drawing-No.: 6.541-5052.01-4
Issue: 3; 22.04.03

Reel Dimensions

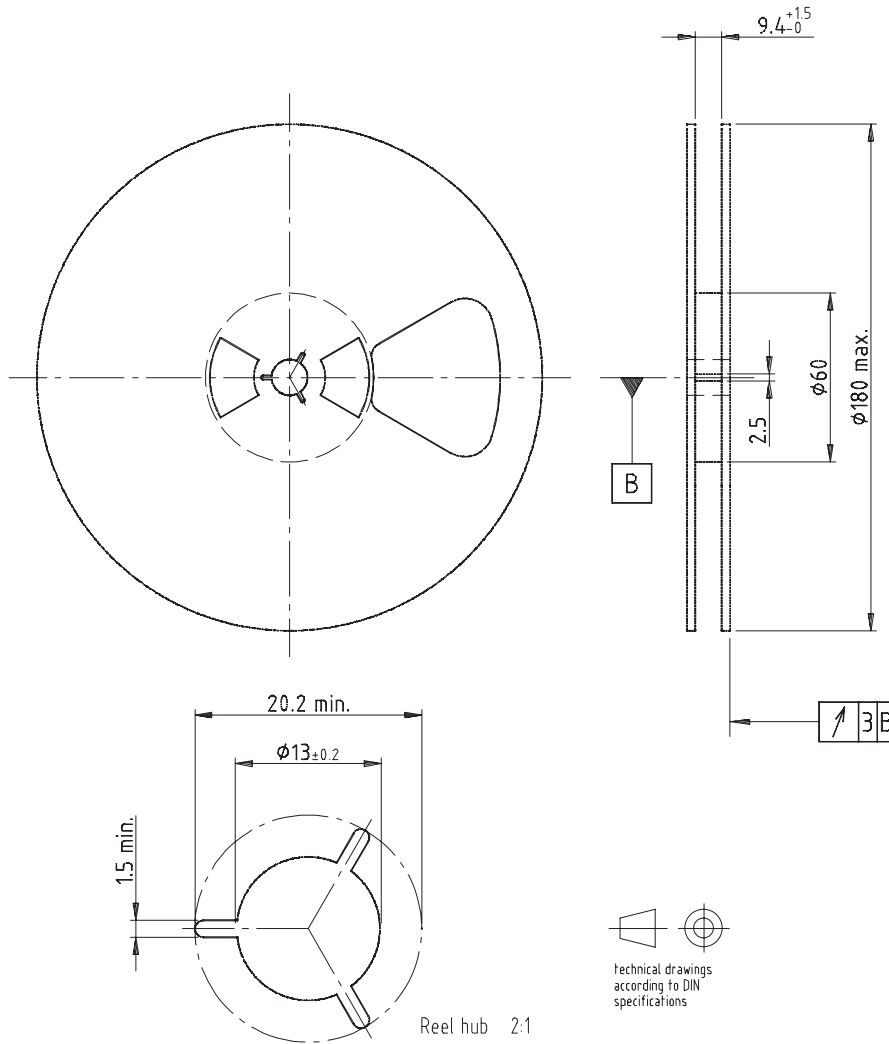

Drawing-No.: 9.800-5051.V5-4
 Issue: 1; 25.07.02

16938

Tape Dimensions

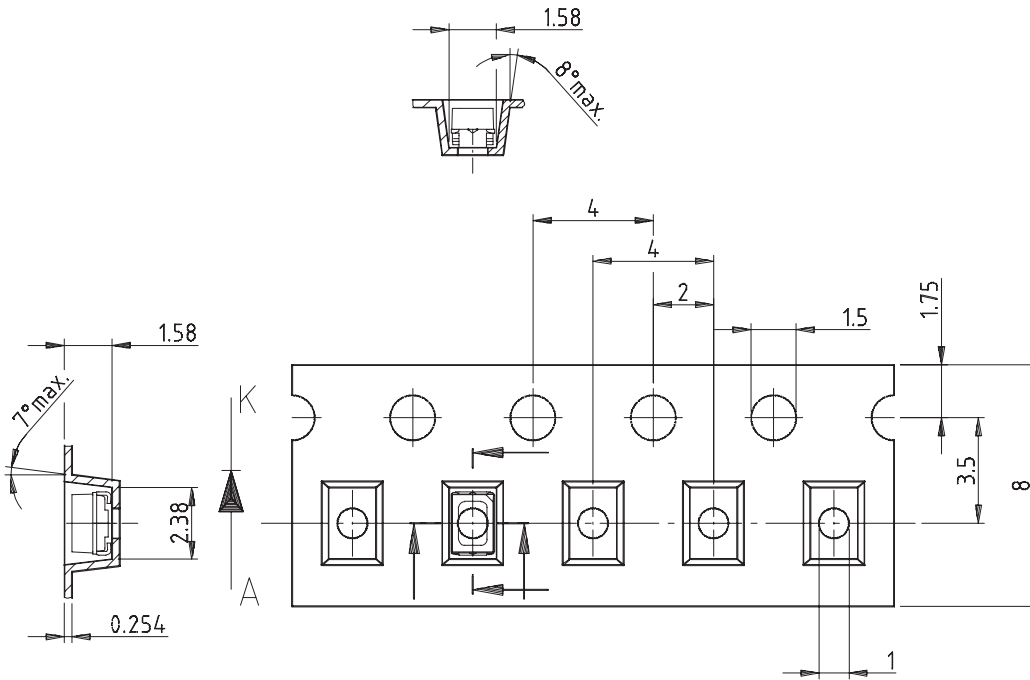

Drawing-No.: 9.700-5266.01-4

Issue: 1; 05.06.02

16939

Leader and Trailer

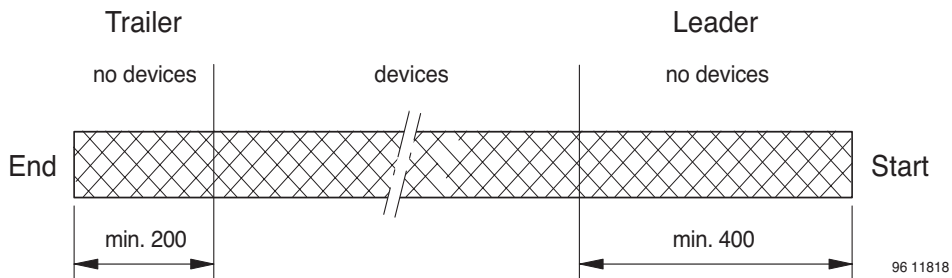

96 11818

GS08 = 3000 pcs



Cover Tape Peel Strength

According to DIN EN 60286-3

0.1 to 1.3 N

300 ± 10 mm/min

165 ° - 180 ° peel angle

Label

Standard bar code labels for finished goods

The standard bar code labels are product labels and used for identification of goods. The finished goods are packed in final packing area. The standard packing units are labeled with standard bar code labels before transported as finished goods to warehouses. The labels are on each packing unit and contain Vishay Semiconductor GmbH specific data.

Vishay Semiconductor GmbH standard bar code product label (finished goods)

Plain Writing	Abbreviation	Length
Item-Description	–	18
Item-Number	INO	8
Selection-Code	SEL	3
LOT-/ Serial-Number	BATCH	10
Data-Code	COD	3 (YWW)
Plant-Code	PTC	2
Quantity	QTY	8
Accepted by:	ACC	–
Packed by:	PCK	–
Mixed Code Indicator	MIXED CODE	–
Origin	xxxxxxx ⁺	Company Logo

Long Bar Code Top	Type	Length
Item-Number	N	8
Plant-Code	N	2
Sequence-Number	X	3
Quantity	N	8
Total Length	–	21

Short Bar Code Bottom	Type	Length
Selection-Code	X	3
Data-Code	N	3
Batch-Number	X	10
Filter	–	1
Total Length	–	17

16942

Dry Packing

The reel is packed in an anti-humidity bag to protect the devices from absorbing moisture during transportation and storage.

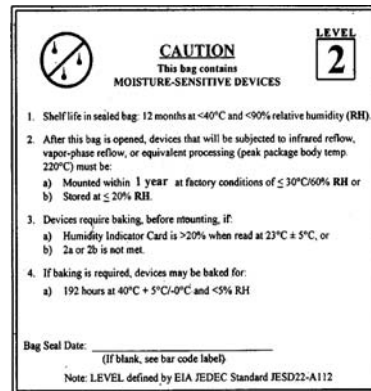
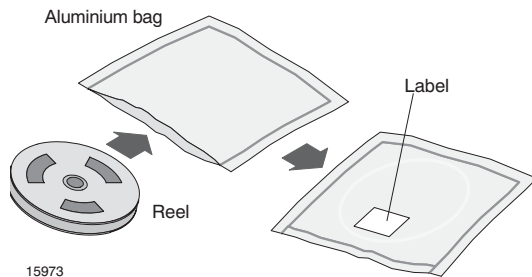

Example of JESD22-A112 Level 2 label

Final Packing

The sealed reel is packed into a cardboard box. A secondary cardboard box is used for shipping purposes.

Recommended Method of Storage

Dry box storage is recommended as soon as the aluminium bag has been opened to prevent moisture absorption. The following conditions should be observed, if dry boxes are not available:

- Storage temperature 10°C to 30°C
- Storage humidity $\leq 60\%$ RH max.

After more than 1 year under these conditions moisture content will be too high for reflow soldering.

In case of moisture absorption, the devices will recover to the former condition by drying under the following condition:

192 hours at $40^{\circ}\text{C} + 5^{\circ}\text{C}/-0^{\circ}\text{C}$ and $< 5\%$ RH
(dry air/ nitrogen) or

96 hours at $60^{\circ}\text{C} + 5^{\circ}\text{C}$ and $< 5\%$ RH for all device containers or

24 hours at $100^{\circ}\text{C} + 5^{\circ}\text{C}$ not suitable for reel or tubes.

An EIA JEDEC Standard JESD22-A112 Level 2 label is included on all dry bags.

ESD Precaution

Proper storage and handling procedures should be followed to prevent ESD damage to the devices especially when they are removed from the Antistatic Shielding Bag. Electro-Static Sensitive Devices warning labels are on the packaging.

Vishay Semiconductors Standard Bar-Code Labels

The Vishay Semiconductors standard bar-code labels are printed at final packing areas. The labels are on each packing unit and contain Vishay Semiconductors specific data.



Ozone Depleting Substances Policy Statement

It is the policy of Vishay Semiconductor GmbH to

1. Meet all present and future national and international statutory requirements.
2. Regularly and continuously improve the performance of our products, processes, distribution and operating systems with respect to their impact on the health and safety of our employees and the public, as well as their impact on the environment.

It is particular concern to control or eliminate releases of those substances into the atmosphere which are known as ozone depleting substances (ODSs).

The Montreal Protocol (1987) and its London Amendments (1990) intend to severely restrict the use of ODSs and forbid their use within the next ten years. Various national and international initiatives are pressing for an earlier ban on these substances.

Vishay Semiconductor GmbH has been able to use its policy of continuous improvements to eliminate the use of ODSs listed in the following documents.

1. Annex A, B and list of transitional substances of the Montreal Protocol and the London Amendments respectively
2. Class I and II ozone depleting substances in the Clean Air Act Amendments of 1990 by the Environmental Protection Agency (EPA) in the USA
3. Council Decision 88/540/EEC and 91/690/EEC Annex A, B and C (transitional substances) respectively.

Vishay Semiconductor GmbH can certify that our semiconductors are not manufactured with ozone depleting substances and do not contain such substances.

We reserve the right to make changes to improve technical design and may do so without further notice.

Parameters can vary in different applications. All operating parameters must be validated for each customer application by the customer. Should the buyer use Vishay Semiconductors products for any unintended or unauthorized application, the buyer shall indemnify Vishay Semiconductors against all claims, costs, damages, and expenses, arising out of, directly or indirectly, any claim of personal damage, injury or death associated with such unintended or unauthorized use.

Vishay Semiconductor GmbH, P.O.B. 3535, D-74025 Heilbronn, Germany
Telephone: 49 (0)7131 67 2831, Fax number: 49 (0)7131 67 2423