

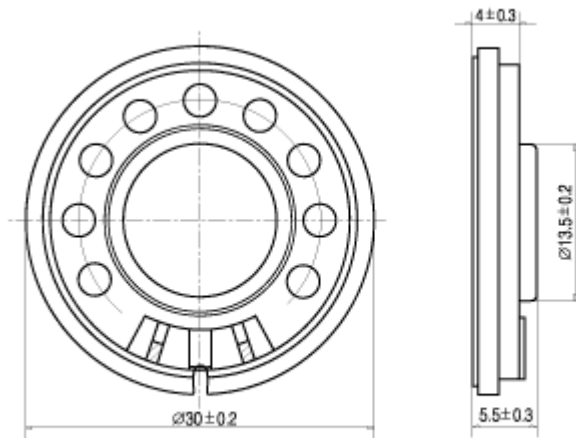

|   |                 |
|---|-----------------|
| Type  | BMS-3012        |
| Rated Impedance( $\Omega$ )                 | $32 \pm 15\%$   |
| Rated(Max.) Power(W)                        | 0.1(0.2)        |
| Resonant Frequency(Hz)                      | $550 \pm 20\%$  |
| Rated Freq.Range(Hz)                        | $f_0 \sim 5000$ |
| Sound Pressure Level(dB)                    | $80 \pm 3$      |
| Magnet(g)                                   | 0.6             |
| Operating Temperature( $^{\circ}\text{C}$ ) | $-10 \sim +40$  |



Unit:mm

