

Hexadecimal and Numeric Displays for Industrial Applications

Technical Data

HDSP-076X Series
HDSP-077X Series
HDSP-086X Series
HDSP-096X Series

Features

- **Three Colors**
 - High-Efficiency Red
 - Yellow
 - High Performance Green
- **Two High-Efficiency Red Options**
 - Low Power
 - High Brightness
- **Three Character Options**
 - Numeric
 - Hexadecimal
 - Over Range
- **Performance Guaranteed over Temperature**

- **Memory Latch/Decoder/Driver**
 - TTL Compatible
- **4 x 7 Dot Matrix Character**
- **Categorized for Luminous Intensity**
- **Yellow and Green Categorized for Color**

Typical Applications

- **Industrial Equipment**
- **Computer Peripherals**
- **Instrumentation**
- **Telecommunication Equipment**

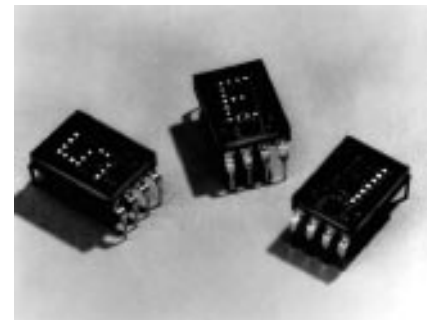

Device Selection Guide

Part Number HDSP-	Color	Description	Front View	
0760	High-Efficiency Red	Numeric, Right Hand DP	A	
0761		Numeric, Left Hand DP	B	
0762		Low Power	Hexadecimal	C
0763			Over Range ± 1	D
0770	High-Efficiency Red	Numeric, Right Hand DP	A	
0771		Numeric, Left Hand DP	B	
0772		High Brightness	Hexadecimal	C
0763			Over Range ± 1	D
0860	Yellow	Numeric, Right Hand DP	A	
0861		Numeric, Left Hand DP	B	
0862		Hexadecimal	Hexadecimal	C
0863			Over Range ± 1	D
0960	Green	Numeric, Right Hand DP	A	
0961		Numeric, Left Hand DP	B	
0962		Hexadecimal	Hexadecimal	C
0963			Over Range ± 1	D

Description

These solid state display devices are designed and tested for use in adverse industrial environments. The character height is 7.4 mm (0.29 inch). The numeric and hexadecimal devices incorporate an on-board IC that contains the data memory, decoder and display driver functions.

The numeric devices decode positive BCD logic into characters "0-9", a "-" sign, decimal point, and a test pattern. The hexadecimal devices decode positive BCD logic into 16 characters, "0-9, A-F." An input is provided on the hexadecimal devices to blank the display (all LEDs off) without losing the contents of the memory.

The over range device displays "± 1" and right hand decimal point and is typically driven via external switching transistors.

Package Dimensions

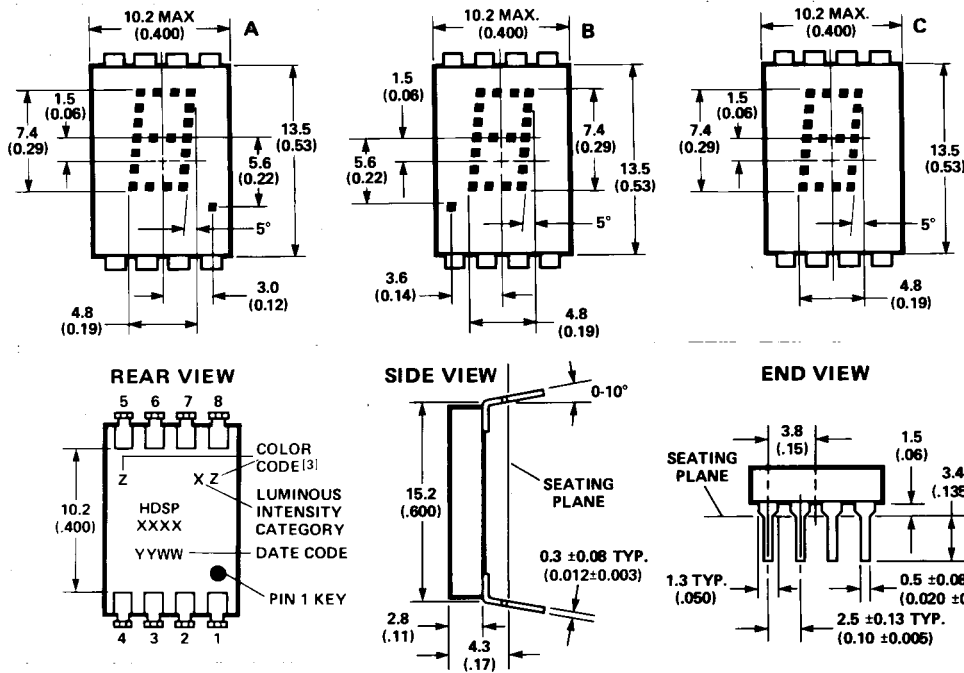

PIN	FUNCTION	
	NUMERIC	HEXA-DECIMAL
1	Input 2	Input 2
2	Input 4	Input 4
3	Input 8	Input 8
4	Decimal point	Blanking control
5	Latch enable	Latch enable
6	Ground	Ground
7	V _{CC}	V _{CC}
8	Input 1	Input 1

- NOTES:
1. Dimensions in millimetres and (inches).
 2. Digit center line is ±0.38 mm (±0.015 inch) from package center line.
 3. Unless otherwise specified, the tolerance on all dimensions is ±0.38 mm (±0.015 inch).
 4. HDSP-0860 and HDSP-0960 series.

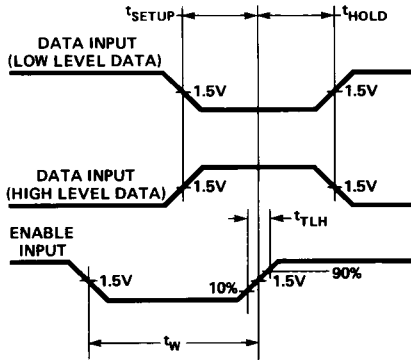

Figure 1. Timing Diagram

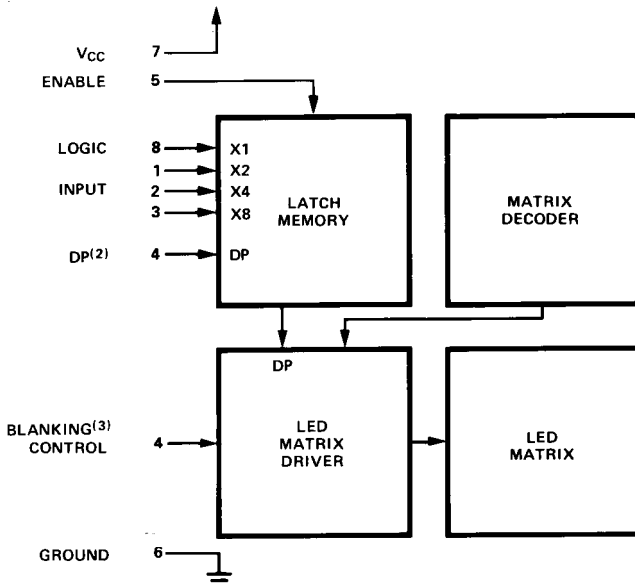

Figure 2. Logic Block Diagram.

TRUTH TABLE					NUMERIC	HEXA-DECIMAL
BCD DATA ⁽¹⁾						
X ₈	X ₄	X ₂	X ₁			
L	L	L	L	0	0	
L	L	L	H	1	1	
L	L	H	L	2	2	
L	L	H	H	3	3	
L	H	L	L	4	4	
L	H	L	H	5	5	
L	H	H	L	6	6	
L	H	H	H	7	7	
H	L	L	L	8	8	
H	L	L	H	9	9	
H	L	H	L	A	A	
H	L	H	H	(BLANK)	B	
H	H	L	L	(BLANK)	C	
H	H	L	H	...	D	
H	H	H	L	(BLANK)	E	
H	H	H	H	(BLANK)	F	
DECIMAL PT. ⁽²⁾				ON	V _{DP} = L	
DECIMAL PT. ⁽²⁾				OFF	V _{DP} = H	
ENABLE ⁽¹⁾				LOAD DATA	V _E = L	
ENABLE ⁽¹⁾				LATCH DATA	V _E = H	
BLANKING ⁽³⁾				DISPLAY-ON	V _B = L	
BLANKING ⁽³⁾				DISPLAY-OFF	V _B = H	

- Notes:
1. H = Logic High; L = Logic Low. With the enable input at logic high changes in BCD input logic levels have no effect upon display memory, displayed character, or DP.
 2. The decimal point input, DP, pertains only to the numeric displays.
 3. The blanking control input, B, pertains only to the hexadecimal displays. Blanking input has no effect upon display memory.

Absolute Maximum Ratings

Description	Symbol	Min.	Max.	Unit
Storage Temperature, Ambient	T_S	-65	+100	°C
Operating Temperature, Ambient ^[1]	T_A	-55	+85	°C
Supply Voltage ^[2]	V_{CC}	-0.5	+7.0	V
Voltage Applied to Input Logic, dp and Enable Pins	V_I, V_{DP}, V_E	-0.5	V_{CC}	V
Voltage Applied to Blanking Input ^[2]	V_B	-0.5	V_{CC}	V
Maximum Solder Temperature at 1.59 mm (0.062 inch) Below Seating Plane, $t \leq 5$ seconds			260	°C

Recommended Operating Conditions

Description	Symbol	Min.	Nom.	Max.	Unit
Supply Voltage ^[2]	V_{CC}	4.5	5.0	5.5	V
Operating Temperature, Ambient ^[1]	T_A	-55		+85	°C
Enable Pulse Width	t_W	100			nsec
Time Data Must Be Held Before Positive Transition of Enable Line	t_{SETUP}	50			nsec
Time Data Must Be Held After Positive Transition of Enable Line	t_{HOLD}	50			nsec
Enable Pulse Rise Time	t_{TLH}			1.0	msec

Optical Characteristics at $T_A = 25^\circ\text{C}$, $V_{CC} = 5.0\text{ V}$

Device	Description	Symbol	Min.	Typ.	Max.	Unit
HDSP-0760 Series	Luminous Intensity per LED (Digit Average) ^[3,4]	I_V	65	140		μcd
	Peak Wavelength	λ_{PEAK}		635		nm
	Dominant Wavelength ^[5]	λ_d		626		nm
HDSP-0770 Series	Luminous Intensity per LED (Digit Average) ^[3,4]	I_V	260	620		μcd
	Peak Wavelength	λ_{PEAK}		635		nm
	Dominant Wavelength ^[5]	λ_d		626		nm
HDSP-0860 Series	Luminous Intensity per LED (Digit Average) ^[3,4]	I_V	215	490		μcd
	Peak Wavelength	λ_{PEAK}		583		nm
	Dominant Wavelength ^[5,6]	λ_d		585		nm
HDSP-0960 Series	Luminous Intensity per LED (Digit Average) ^[3,4]	I_V	298	1100		μcd
	Peak Wavelength	λ_{PEAK}		568		nm
	Dominant Wavelength ^[5,6]	λ_d		574		nm

Notes:

- The nominal thermal resistance of a display mounted in a socket that is soldered onto a printed circuit board is $R\theta_{JA} = 50^\circ\text{C/W}$ /device. The device package thermal resistance is $R\theta_{J-PIN} = 15^\circ\text{C/W}$ /device. The thermal resistance device pin-to-ambient through the PC board should not exceed 35°C/W /device for operation at $T_A = +85^\circ\text{C}$.
- Voltage values are with respect to device ground, pin 6.
- These displays are categorized for luminous intensity with the intensity category designated by a letter code located on the back of the display package. Case temperature of the device immediately prior to the light measurement is equal to 25°C .

Electrical Characteristics; $T_A = -55^\circ\text{C}$ to $+85^\circ\text{C}$

Description	Symbol	Test Conditions	Min.	Typ. ^[7]	Max.	Unit
Supply Current HDSP-0760 Series	I_{CC}	$V_{CC} = 5.5\text{ V}$ (Characters "5." or "B" Displayed)		78	105	mA
HDSP-0770 Series				120	175	
HDSP-0860 Series						
HDSP-0960 Series						
Power Dissipation HDSP-0760 Series	P_T			390	573	mW
HDSP-0770 Series				690	963	
HDSP-0860 Series						
HDSP-0960 Series						
Logic, Enable and Blanking Low-Level Input Voltage	V_{IL}	$V_{CC} = 4.5\text{ V}$			0.8	V
Logic, Enable and Blanking High-Level Input Voltage	V_{IH}		2.0			V
Logic and Enable Low-Level Input Current	I_{IL}	$V_{CC} = 5.5\text{ V}$			-1.6	mA
Blanking Low-Level Input Current	I_{BL}	$V_{IL} = 0.4\text{ V}$			-10	μA
Logic, Enable and Blanking High-Level Input Current	I_{IH}	$V_{CC} = 5.5\text{ V}$ $V_{IH} = 2.4\text{ V}$			+40	μA
Weight				1.0		gm
Leak Rate					5×10^{-8}	cc/sec

Notes:

4. The luminous intensity at a specific operating ambient temperature, $I_V(T_A)$ may be approximated from the following exponential equation: $I_V(T_A) = I_V(25^\circ\text{C}) e^{[k(T_A - 25^\circ\text{C})]}$.

Device	K
HDSP-0760 Series HDSP-0770 Series	-0.0131/ $^\circ\text{C}$
HDSP-0860 Series	-0.0112/ $^\circ\text{C}$
HDSP-0960 Series	-0.0104/ $^\circ\text{C}$

5. The dominant wavelength, λ_d , is derived from the CIE Chromaticity Diagram and is that single wavelength which defines the color of the device.
6. The HDSP-0860 and HDSP-0960 series devices are categorized as to dominant wavelength with the category designated by a number on the back of the display package.
7. All typical values at $V_{CC} = 5.0\text{ V}$ and $T_A = 25^\circ\text{C}$.

Operational Considerations

Electrical

These devices use a modified 4 x 7 dot matrix light emitting diode to display decimal/hexadecimal numeric information. The high efficiency red and yellow LEDs are GaAsP epitaxial layer on a GaP transparent substrate. The green LEDs are GaP epitaxial layer on a GaP transparent substrate. The LEDs are driven by constant current drivers, BCD information is accepted by the display memory when the enable line is at logic low and the data is latched when the enable is at logic high. Using the enable pulse width and data setup and hold times listed in the Recommended Operating Conditions allows data to be clocked into an array of displays at a 6.7 MHz rate.

The decimal point input is active low true and this data is latched into the display memory in the same fashion as the BCD data. The decimal point LED is driven by the on-board IC.

The blanking control input on the hexadecimal displays blanks (turns off) the displayed information without disturbing the contents of display memory. The display is blanked at a minimum threshold level of 2.0 volts. When blanked, the display standby power is nominally 250 mW at $T_A = 25^\circ\text{C}$.

Mechanical

The primary thermal path for power dissipation is through the device leads. Therefore, to insure reliable operation up to an ambient temperature of $+85^\circ\text{C}$, it is important to maintain a case-to-ambient thermal resistance of less than 35°C watt/device as measured on top of display pin 3.

For information on soldering and post solder cleaning see Application Note 1027, *Soldering LED Components*.

Contrast Enhancement

These display devices are designed to provide an optimum ON/OFF contrast when placed behind an appropriate contrast enhancement filter. For further information, please refer to Application Note 1015, *Contrast Enhancement Techniques for LED Displays*.

Over Range Display

The over range devices display “± 1” and decimal point. The character height and package configuration are the same as the numeric and hexadecimal devices. Character selection is obtained via external switching transistors and current limiting resistors.

Package Dimensions

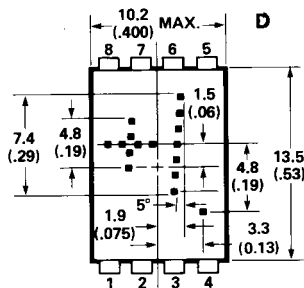

FRONT VIEW

NOTE: 1. DIMENSIONS IN MILLIMETRES AND (INCHES).

Pin	Function
1	Plus
2	Numeral One
3	Numeral One
4	DP.
5	Open
6	Open
7	V _{CC}
8	Minus/Plus

Character	Pin			
	1	2,3	4	8
+	1	X	X	1
-	0	X	X	1
1	X	1	X	X
Decimal Point	X	X	1	X
Blank	0	0	0	0

Notes:

0: Line switching transistor in Figure 7 cutoff.

1: Line switching transistor in Figure 7 saturated.

X: 'don't care'

Absolute Maximum Ratings

Description	Symbol	Min.	Max.	Unit
Storage Temperature, Ambient	T_S	-65	+100	°C
Operating Temperature, Ambient	T_A	-55	+85	°C
Forward Current, Each LED	I_F		10	mA
Reverse Voltage, Each LED	V_R		5	V

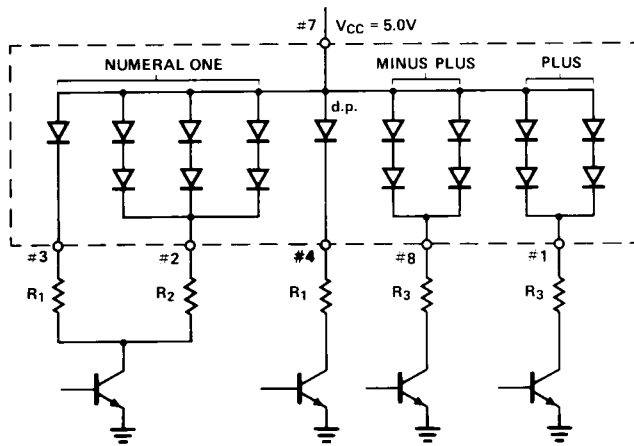

Figure 3. Typical Driving Circuit.

Recommended Operating Conditions $V_{CC} = 5.0\text{ V}$

Device	Forward Current Per LED, mA	Resistor Value			
		R_1	R_2	R_3	
HDSP-0763	Low Power	2.8	1300	200	300
	High Brightness	8	360	47	68
HDSP-0863	8	360	36	56	
HDSP-0963	8	360	30	43	

Luminous Intensity per LED

(Digit Average)^[3,4] at $T_A = 25^\circ\text{C}$

Device	Test Conditions	Min.	Typ.	Units
HDSP-0763	$I_F = 2.8\text{ mA}$	65	140	μcd
	$I_F = 8\text{ mA}$		620	μcd
HDSP-0863	$I_F = 8\text{ mA}$	215	490	μcd
HDSP-0963	$I_F = 8\text{ mA}$	298	1100	μcd

Electrical Characteristics: $T_A = -55^{\circ}\text{C}$ to $+85^{\circ}\text{C}$

Device	Description	Symbol	Test Conditions	Min.	Typ.	Max.	Unit
HDSP-0763	Power Dissipation (All LEDs illuminated)	P_T	$I_F = 2.8 \text{ mA}$		72		mW
			$I_F = 8 \text{ mA}$		224	282	
	Forward Voltage per LED	V_F	$I_F = 2.8 \text{ mA}$		1.6		V
			$I_F = 8 \text{ mA}$		1.75	2.2	
HDSP-0863	Power Dissipation (All LEDs illuminated)	P_T	$I_F = 8 \text{ mA}$		237	282	mW
	Forward Voltage per LED	V_F			1.90	2.2	V
HDSP-0963	Power Dissipation (All LEDs illuminated)	P_T	$I_F = 8 \text{ mA}$		243	282	mW
	Forward Voltage per LED	V_F			1.85	2.2	V

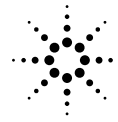

Agilent Technologies
Innovating the HP Way

www.semiconductor.agilent.com

Data subject to change.

Copyright © 1999 Agilent Technologies, Inc.

Obsoletes 5953-9395 (1/84)

5963-7395E (11/99)