

17.3 mm (0.68 inch) General Purpose 5 x 7 Dot Matrix Alphanumeric Displays

Technical Data

- HDSP-70xE Series
- HDSP-71xE Series
- HDSP-70xG Series
- HDSP-71xG Series
- HDSP-70xA Series
- HDSP-71xA Series

Features

- 5 x 7 Dot Matrix Font
- Viewable up to 12 Meters
- X-Y Stackable
- Industry Standard Pin-out
7.6 mm (0.3 in.) Dual-in-line (DIP) Leads on 2.54 mm (0.1 in.) Centers
- Choice of Colors
Red or Green or AlGaAs
- Choice of Face Paint Colors
Gray or Black
- Design Flexibility
Common Row Anode or Common Row Cathode
- Categorized for Luminous Intensity
- Green Categorized for Color

Applications

- Suitable for Indoor Use
- Not Recommended for Industrial Applications, i.e. Operating Temperatures Requirements Exceeding 85°C or Below -35°C^[1]
- Extreme Temperature Cycling Not Recommended^[2]

Description

These displays have a 17.3 mm (0.68 inch) character height and use industry standard size and pin-out. The devices are available in either common row anode or common row cathode configurations. The displays come in either gray or black face paint and are available in a choice of high efficiency red (HER) or green colors or AlGaAs.

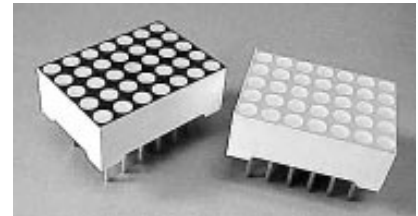

These parts are subjected to Outgoing Quality Assurance (OQA) inspection with an AQL of 0.065% for functional and visual/cosmetic defects.

For optimal intensity performance, please consider our industrial grade displays:

- HDSP-L20x
- HDSP-540x
- HDSP-L10x

Devices

HER HDSP-	Green HDSP-	AlGaAs HDSP-	Description
701E	701G	701A	17.3 mm Gray Surface Common Row Anode
703E	703G	703A	17.3 mm Gray Surface Common Row Cathode
711E	711G	711A	17.3 mm Black Surface Common Row Anode
713E	713G	713A	17.3 mm Black Surface Common Row Cathode

Notes:

1. For industrial applications, it is recommended to use HDSP-L201/L203/5401/5403/L101/L103.
2. For details, please contact your local Agilent components sales office or an authorized distributor.

Package Dimensions

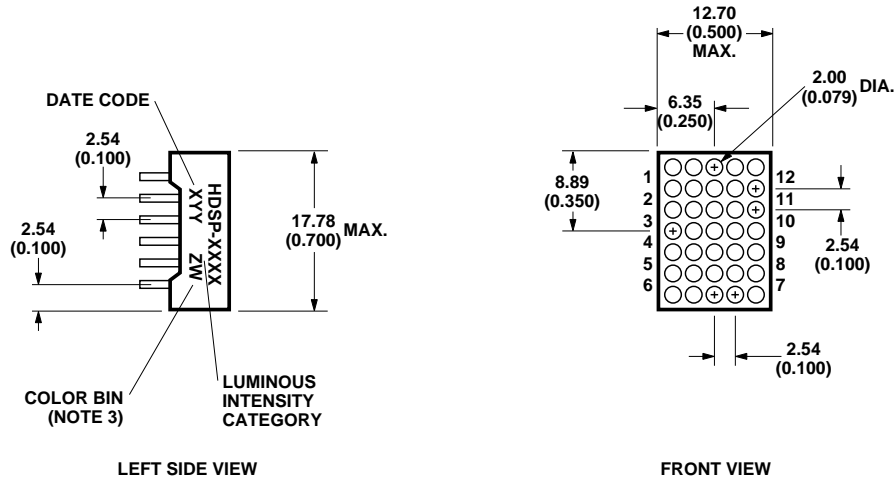

- NOTES:
 1. ALL DIMENSIONS IN MILLIMETERS (INCHES).
 2. ALL UNTOLERANCED DIMENSIONS ARE FOR REFERENCE ONLY.
 3. FOR GREEN ONLY.

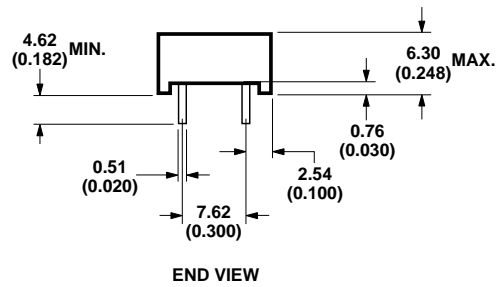

Internal Circuit Diagram

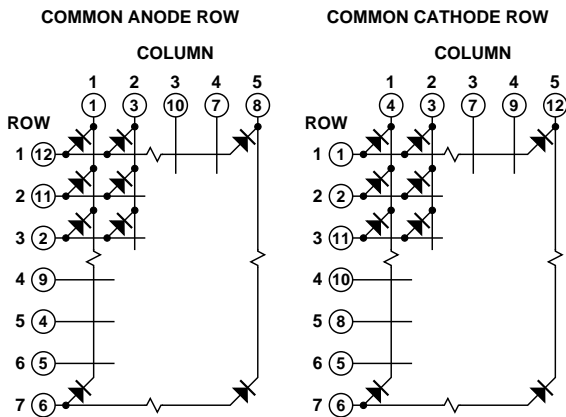

x = ROW OR COLUMN NUMBER, (x) = PIN NUMBER

COMMON ROW ANODE		COMMON ROW CATHODE	
PIN	HDSP-701E/711E/ 701G/711G/701A/711A	PIN	HDSP-703E/713E/ 703G/713G/703A/713A
1	COLUMN 1 CATHODE	1	ROW 1 CATHODE
2	ROW 3 ANODE	2	ROW 2 CATHODE
3	COLUMN 2 CATHODE	3	COLUMN 2 ANODE
4	ROW 5 ANODE	4	COLUMN 1 ANODE
5	ROW 6 ANODE	5	ROW 5 CATHODE
6	ROW 7 ANODE	6	ROW 7 CATHODE
7	COLUMN 4 CATHODE	7	COLUMN 3 ANODE
8	COLUMN 5 CATHODE	8	ROW 5 CATHODE
9	ROW 4 ANODE	9	COLUMN 4 ANODE
10	COLUMN 3 CATHODE	10	ROW 4 CATHODE
11	ROW 2 ANODE	11	ROW 3 CATHODE
12	ROW 1 ANODE	12	COLUMN 5 ANODE

Absolute Maximum Ratings at $T_A = 25^\circ\text{C}$

Parameter	HER HDSP-701E/ 711E/703E/ 713E	AlGaAs HDSP-701A/ 703A/711A/ 713A	Green HDSP-701G/ 711G/703G/ 713G	Units
Average Power per Dot ^[1]	65	75	65	mW
Peak Forward Current per Dot ^[1,2] (1/10 Duty Cycle, 0.1 ms Pulse Width)	40	125	40	mA
Average Forward Current per Dot ^[1]	25	23 ^[3]	25	mA
Reverse Voltage per Dot	3	3	3	V
Operating Temperature	-35 to +85	-35 to +85	-35 to +85	°C
Storage Temperature	-35 to +85	-35 to +85	-35 to +85	°C
Lead Solder Temperature for 3 seconds ^[3] (1.6 mm [0.063 in.] below seating plane)	260	260	260	°C

Notes:

- Do not exceed maximum average current per dot.
- Derate above 25°C at 0.2 mA/°C.
- Not recommended to be soldered more than 2 times. Minimum interval between solderings is 15 minutes. Total soldering time not to exceed 5 seconds.

Optical/Electrical Characteristics at $T_A = 25^\circ\text{C}$

High Efficiency Red

Devices HDSP-	Parameter	Symbol	Min.	Typ.	Max.	Units	Test Conditions
701E 711E 703E 713E	Luminous Intensity/Dot (Digit Average) ^[1]	I_V	1.3	3.6		med	$I_F = 50\text{ mA}$, 20% Duty Factor
	Peak Wavelength	λ_{PEAK}		635		nm	
	Dominant Wavelength ^[2]	λ_d		626		nm	
	Forward Voltage	V_F		2.6	3.5	V	$I_F = 50\text{ mA}$
	Reverse Voltage ^[3]	V_R	3.0	25		V	$I_R = 100\ \mu\text{A}$
	Temperature Coefficient of V_F	$\Delta V_F/^\circ\text{C}$		-2		mV/°C	

Green

Devices HDSP-	Parameter	Symbol	Min.	Typ.	Max.	Units	Test Conditions
701G 711G 703G 713G	Luminous Intensity/Dot (Digit Average) ^[1]	I_V	0.96	4.0		med	$I_F = 50\text{ mA}$, 20% Duty Factor
	Peak Wavelength	λ_{PEAK}		566		nm	
	Dominant Wavelength ^[2]	λ_d		571		nm	
	Forward Voltage	V_F		2.6	3.5	V	$I_F = 50\text{ mA}$
	Reverse Voltage ^[3]	V_R	3.0	25		V	$I_R = 100\ \mu\text{A}$
	Temperature Coefficient of V_F	$\Delta V_F/^\circ\text{C}$		-2		mV/°C	

Notes:

- The digits are categorized for luminous intensity. The intensity category is designated by a letter on the side of the package.
- The dominant wavelength λ_d is derived from the CIE chromaticity diagram and represents the single wavelength which defines the color of the device.
- Typical specification for reference only. Do not exceed absolute maximum ratings.

AlGaAs

Devices HDSP-	Parameter	Symbol	Min.	Typ.	Max.	Units	Test Conditions
701A 711A 703A 713A	Luminous Intensity/Dot (Digit Average) ^[1]	I _V	1.4	3.5	8.5	mcd	I _F = 10 mA, 20% Duty Factor
	Peak Wavelength	λ _{PEAK}		660		nm	
	Dominant Wavelength ^[2]	λ _d		643		nm	
	Forward Voltage	V _F			2.0	V	I _F = 10 mA
	Reverse Voltage ^[3]	V _R	3.0	25		V	I _R = 100 μA

Notes:

- The digits are categorized for luminous intensity. The intensity category is designated by a letter on the side of the package.
- The dominant wavelength λ_d is derived from the CIE chromaticity diagram and represents the single wavelength which defines the color of the device.
- Typical specification for reference only. Do not exceed absolute maximum ratings.

**Intensity Bin Limits^[1]
(mcd at 50 mA, 20% Duty Factor)**
High Efficiency Red

Bin name	Min. ^[2]	Max. ^[2]
E	1.289	1.934
F	1.934	2.900
G	2.900	4.350
H	4.350	6.525

Notes:

- Bin categories are established for classification of products.
Products may not be available in all bin categories.
- Tolerance for each intensity bin limit is ± 10%.

Green

Bin name	Min. ^[2]	Max. ^[2]
H	0.96	1.44
I	1.44	2.15
J	2.15	3.23
K	3.23	4.85
L	4.85	7.28

(mcd at 10 mA, 20% Duty Factor)
AlGaAs

Bin name	Min. ^[2]	Max. ^[2]
I	1.40	2.56
J	2.10	3.84
K	3.14	5.75
L	4.70	8.55

Notes:

- Bin categories are established for classification of products.
Products may not be available in all bin categories.
- Tolerance for each intensity bin limit is ± 10%.

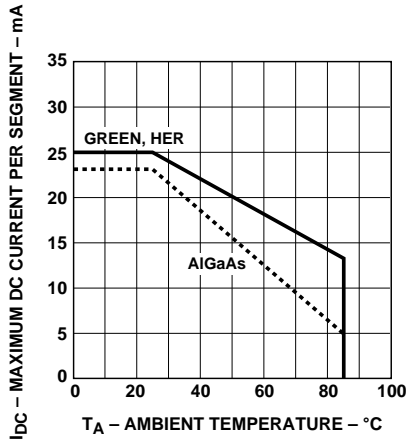

Figure 1. Maximum Allowable Average Current Per Dot vs. Ambient Temperature.

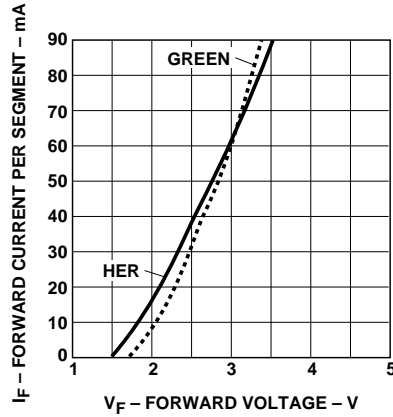

Figure 2. Forward Current vs. Forward Voltage.

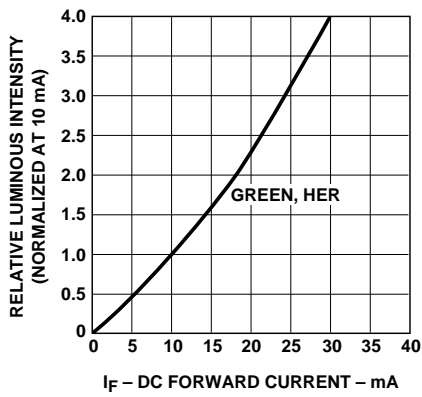

Figure 3. Relative Luminous Intensity vs. DC Forward Current.

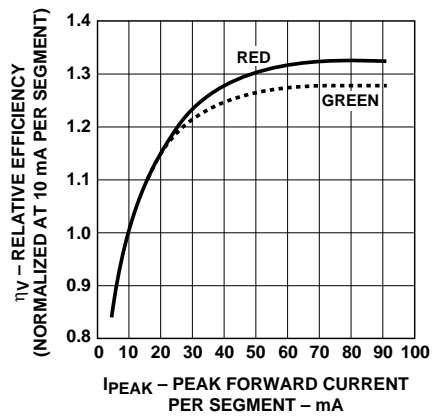
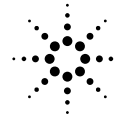

Figure 4. Relative Efficiency (Luminous Intensity Per Unit Current Per Dot) vs. Peak Current Per Dot.



Contrast Enhancement

For information on contrast enhancement please see Application Note 1015.

Soldering/Cleaning

Cleaning agents from the ketone family (acetone, methyl ethyl ketone, etc.) and from the chlorinated hydrocarbon family (methylene chloride, trichloroethylene, carbon tetrachloride, etc.) are not recommended for cleaning LED parts. All of these various solvents attack or dissolve the encapsulating epoxies used to form the package of plastic LED parts.

For information on soldering LEDs please refer to Application Note 1027.

Device Reliability

For reliability information, please see the reliability datasheet 17.3 mm General Purpose 5 x 7 Dot Matrix Alphanumeric Displays.