



# Micro-PRO

Field  
Programmable  
Hardware

State-of-the-art  
Device Programmer

# USER GUIDE

(Revision 1.04)



**The Embedded Solutions Company**

## Copyright Information

Information in this document is subject to change without notice and does not represent a commitment on the part of the manufacturer. The software described in this document is furnished under license agreement or nondisclosure agreement and may be used or copied only in accordance with the terms of the agreement.

It is against the law to copy the software on any medium except as specifically allowed in the license or nondisclosure agreement.

The purchaser may make one copy of the software for backup purposes. No part of this manual may be reproduced or transmitted in any form or by any means, electronic, mechanical, including photocopying, recording, or information retrieval systems, for any purpose other than for the purchaser's personal use, without written permission.

(C) 1994-1997 Copyright Equinox Technologies. All rights reserved.

Atmel™ and AVR™ are trademarks of the Atmel Corporation

Keil C51™ and dScope™ are trademarks of Keil Elektronik GmbH

Microsoft, MS-DOS, Windows™ and Windows 95™ are registered trademarks of the Microsoft Corporation

IBM, PC and PS/2 are registered trademarks of International Business Machines Corporation

Intel, MCS 51, ASM-51 and PL/M-51 are registered trademarks of the Intel Corporation

Every effort was made to ensure accuracy in this manual and to give appropriate credit to persons, companies and trademarks referenced herein.

## **Contacts**

### **Equinox Technologies UK Limited**

3 Atlas House, St Georges Square, Bolton, England BL1 2HB

**Telephone Sales** ..... : **+44 (0) 1204 529000**

**Fax** ..... : **+44 (0) 1204 535555**

**E-mail** ..... : **sales@equinox-tech.com**

**Web site** ..... : **www.equinox-tech.com**

**For technical support on this product please e-mail us at:**  
**micropro@equinox-tech.com**

### **Software Updates**

In line with our policy of continuous improvement, the 'Meridian for Windows™' software is updated on a regular basis. If you would like to receive an automatic e-mail every time a new version is released, please make sure you have registered your system with Equinox and you have quoted your e-mail address. You may cancel this service at any time.

The Meridian software updates can currently be downloaded from the following places:

**Internet** : [www.equinox-tech.com](http://www.equinox-tech.com)

**ftp site** : [ftp.equinox-tech.com](ftp://ftp.equinox-tech.com)

**Atmel BBS** : +1 408 436-4309

# **Contents**

INTRODUCTION .....	1
SYSTEM SPECIFICATIONS .....	2
INSTALLATION OVERVIEW .....	3
HARDWARE INSTALLATION INSTRUCTIONS .....	4
SOFTWARE INSTALLATION .....	5
PARALLEL PORT SELECTION .....	6
HARDWARE OVERVIEW .....	7
SOFTWARE OVERVIEW .....	8
DEVICE SELECTION .....	10
DEVICE POSITION & ORIENTATION .....	11
DEVICE SUPPORT .....	12
8051 SUPPORT PRODUCTS GUIDE .....	14
AVR SUPPORT PRODUCTS GUIDE .....	15
MISCELLANEOUS ACCESSORIES .....	16

## Introduction

**T**he Micro-Pro is a state-of-the-art device programmer supporting a wide range of programmable devices. The programmer was originally developed to program the Atmel AT89C and AT89S microcontroller families, but support has now been widened to include many other 8051 derivatives and also a selection of popular Atmel FLASH and EEPROM memories.

The Micro-Pro programmer features extremely fast programming speeds due to its optimised field-programmable hardware. Further speed enhancements have been made possible by virtue of the parallel data connection to the PC. The powerful front-end software caters for both involved development cycle programming needs and production batch programming requirements.

## MICRO-PRO DEVICE PROGRAMMER HIGHLIGHTS

- State-of-the-art Device Programmer
- Supports the entire Atmel 89C & 89S microcontroller families as standard
- Supports many generic 8051 devices (87C51-FA/FB/FC)
- Supports many Atmel AVR microcontroller derivatives
- Also supports many Atmel FLASH, EEPROM and Configurator devices
- Field Programmable hardware ensures future device support
- FAST programming times due to optimised hardware/software algorithm for each device
- Device Manufacturer Certification for many algorithms
- Supports most DIL devices up to 40 pins without an adaptor
- Adaptors available for many other package types
- Connects to spare PC parallel port
- Straightforward hardware/software installation
- Supports programming of security lock bits security tables and special option bits

## **System Specifications**

### **MINIMUM SYSTEM CONTENTS**

Micro-Pro Device Programmer  
Power Supply (PSU)  
Parallel Cable (25w M/M pin to pin)

### **MICRO-PRO PARALLEL PROGRAMMER SPECIFICATIONS**

Programmer Size : 10.5 x 8 x 2 cm  
Shipped Weight : approx 1.5kg  
PSU : 15V DC @250mA  
Port connection : Parallel 25-way D  
ZIF socket : Quality 40way socket  
Accepts both 0.3/0.6" pitch devices

### **MINIMUM PC REQUIREMENTS**

The minimum hardware and software requirements to ensure that the programmer operates correctly are as follows:

100% IBM compatible 386+  
Windows 3.1 or higher  
Minimum 4MB RAM  
Minimum 1MB free hard disk space  
Spare PC parallel port

## Installation Overview

The Hardware/Software Overview for the installation process of the Micro-Pro programmer is detailed diagrammatically below. Please refer to the following pages for a more detailed explanation.

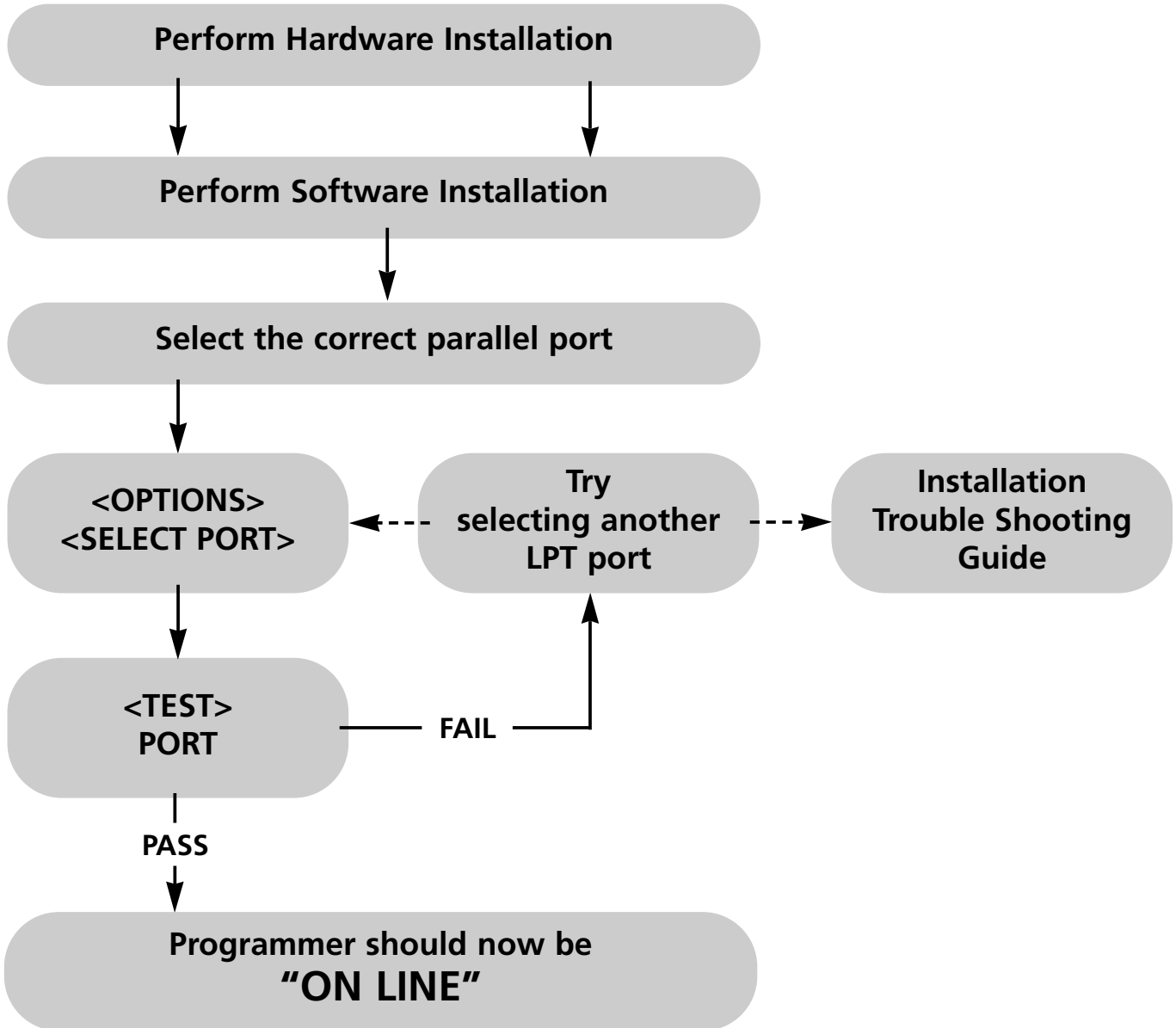

## Hardware Installation Instructions

### OVERVIEW

The Micro-Pro programmer connects to any spare PC **parallel** (LPT) port. If you only have one parallel port and this is in use for eg. a printer, it may be possible to add a second parallel port to your machine by inserting a new I/O card. If you are limited to one parallel port eg. on a laptop, then it is necessary to remove any other devices connected to that parallel port for the duration of using the Micro-Pro.

For further hardware installation help, please refer to the **Installation Troubleshooting Guide**.

*Connect the programmer to the PC as follows:*

- 1 Plug male end of PC parallel cable into spare PC parallel port
- 2 Plug female end of PC parallel cable into 25-way connector on the programmer
- 3 Plug power jack into programmer
- 4 Plug mains adaptor into suitable mains supply

**The programmer RED 'POWER' LED should now be illuminated**

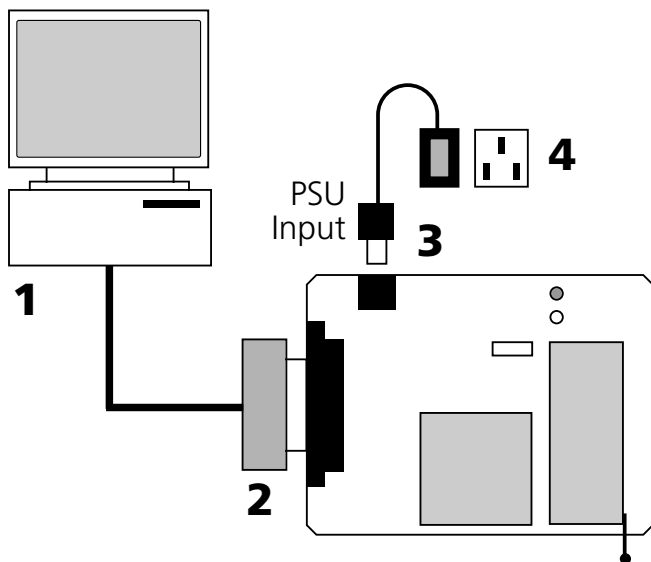



## Software Installation

The Micro-Pro programmer is supplied with 'Micro-Pro for Windows' PC driver software. This software is supplied on one 3.5" floppy disk.

### TO INSTALL 'MICRO-PRO FOR WINDOWS' SOFTWARE:

- Boot the PC into Windows environment (Win 3.1 or Win 95 )
- Insert 'Micro-Pro for Windows' disk into floppy disk drive (A: / B:)
- Select the 'Run...' command from the 'File' menu in the Program Manager
- Select 'Browse' and navigate to the floppy drive (A: / B:)
- Select 'micropro.exe'
- Select the 'OK' button

The software installation program should now display an introductory screen. Please follow the on-screen prompts in order to complete the software installation process.

For more detailed information on which libraries to install, please refer to the 'Device Support' section.

On completion, the installation program will install the 'Micro-Pro' icon within a new program group called 'Micro-Pro'.

To launch the software, simply double-click on the 'Micro-Pro' icon.



## Parallel Port Selection (Select Port)

The Micro-Pro programmer plugs into a spare parallel port of any IBM compatible PC including the majority of laptop machines.

The programmer should operate correctly in the following parallel port (LPT) modes:

- i. Uni-directional mode
- ii. Bi-directional (Enhanced or EPP) mode

However, if the programmer fails to be detected it is worth switching the LPT mode between uni and bi-directional using the PC bios and then re-trying the communication test.

### TO SELECT THE CORRECT PARALLEL PORT (LPT):

- i. From the menu bar select <Options> <Select Port>

The available LPT ports on your computer together with the corresponding address are now displayed. eg. LPT1 (\$378)

If you have more than one parallel port on your PC, but only one LPT address is displayed, it is likely that your hardware setup requires adjusting in the PC bios.

- ii. Select the LPT port to which the programmer is connected

- iii. Select <Test>

A programmer communications test is now performed.

This tests both the programmer, cable and PC parallel port.

### COMMUNICATIONS TEST PASS

The programmer has been detected OK by the Micro-Pro software. If you now <Cancel> out of the <Test Port> dialogue box, the words 'ON LINE' should now be displayed at the bottom right of the Micro-Pro Window.

Installation is complete and the programmer should now be ready to-use.

### COMMUNICATIONS TEST FAIL

The programmer was not detected on the LPT port selected. Please check that the correct LPT port was selected, and if not, repeat the <Select Port> < Test> operation.

If the programmer is still not detected, please refer to the Installation Troubleshooting Guide located in the help file on disk.

## Hardware Overview

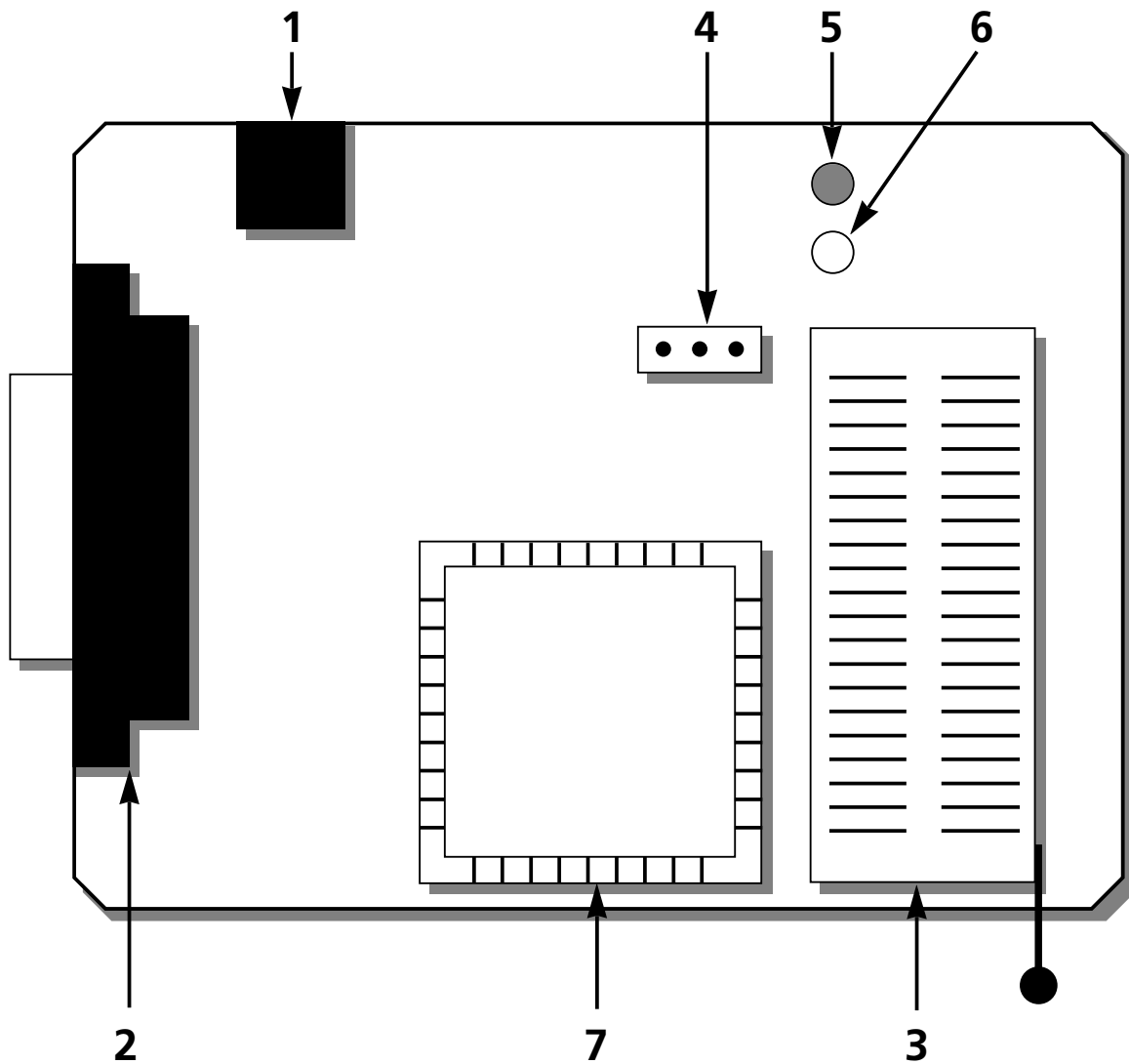

### Key

- 1 PSU input
- 2 Parallel cable connection (to PC)
- 3 ZIF (Zero Insertion Force) socket (40 way)
- 4 Auxiliary power connector
- 5 Power LED (Red)
- 6 Active LED (Yellow)
- 7 Atmel AT6002 FPGA

## Software Overview

The Micro-Pro for Windows software features many powerful functions which can be activated by simply clicking a single icon. Other utilities and commands are available by selecting the relevant menu option.

For further information about the Micro-Pro for Windows software , please refer to the 'On-line Help System' supplied with the software.

The most commonly used functions for which an icon exists are listed below.

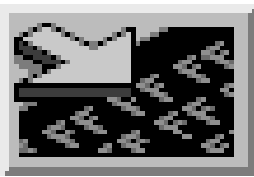

### **LOAD FILE TO BUFFER** (F9 or Ctrl + L)

Allows you to select a file or multiple files and load the file(s) into the programmer buffer area(s). Currently supports Intel Hex and Binary file formats as standard.

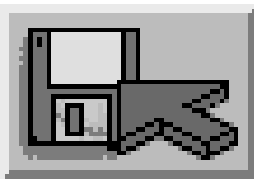

### **SAVE TO DISK** (Ctrl + S)

Allows you to save the contents of the buffer(s) to a file. Currently supports Intel Hex and Binary file formats as standard.

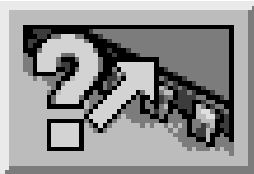

### **BLANK CHECK**

Checks if the currently selected device is blank.  
i.e. All locations = FFh



### **VERIFY DEVICE**

Compares the contents of the buffer area(s) with the contents of the currently selected device.

## **Software Overview** continued

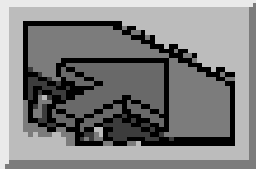

### **PROGRAM DEVICE**

Programs device with contents of buffer



### **DEVICE READ**

Reads the contents of the currently selected device into the programmer buffer area(s).

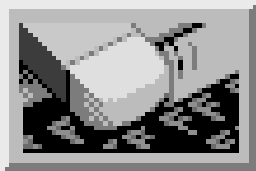

### **ERASE DEVICE**

Performs an ELECTRONIC erase on the currently selected device. Please note: OTP and EPROM devices do not support an ELECTRONIC erase cycle.

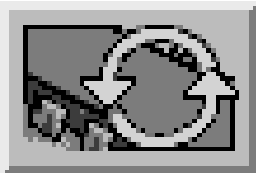

### **DEVICE AUTO-PROGRAM**

Performs a complete programming cycle including Signature Check, Erase, Blank check, Program, Special Options, Security etc



### **SPECIAL OPTIONS**

Allows you to READ/WRITE the special option bits of certain devices which support non-standard features.



### **SECURITY**

Allows you to READ/WRITE the security lock bits of any device which supports this feature.

## Device Selection

It is necessary to select the particular device to be programmed as follows:

e.g. To select the Atmel AT89S8252 microcontroller as the current device

- 1 Select the **DEVICE** menu and choose **SELECT**

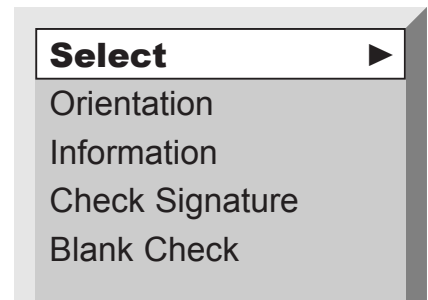

- 2 You will now be presented with a list of device types

Choose **MICROCONTROLLER**

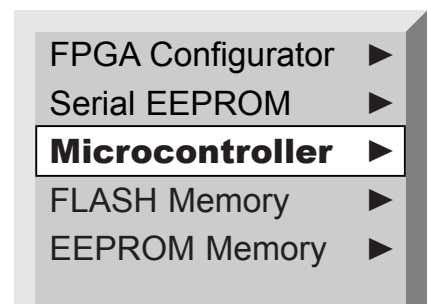

- 3 A list of device manufacturers is now displayed

Select the one you require i.e. Atmel

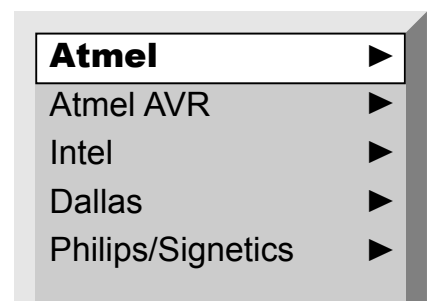

- 4 A list of microcontroller devices produced by that manufacturer is now displayed.

Select the one you require i.e. AT89S8252

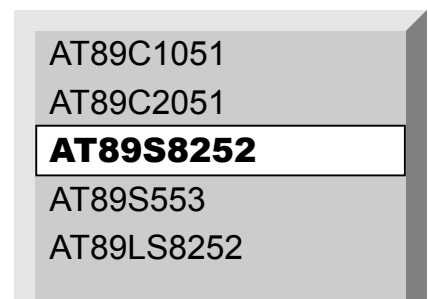

*The currently selected device is now active*

## Device Position & Orientation

The Micro-Pro programmer accepts a wide variety of devices in dual-in-line (DIL) packages without the need for additional package adaptors or convertors. The Zero Insertion Force (ZIF) socket caters for DIL device with up to 40 pins and can also accept both 0.3" and 0.6" pitch devices.

The diagram below shows the correct position and orientation of the target device in the ZIF socket. The position of pin 1 of the target device is marked by a dot.

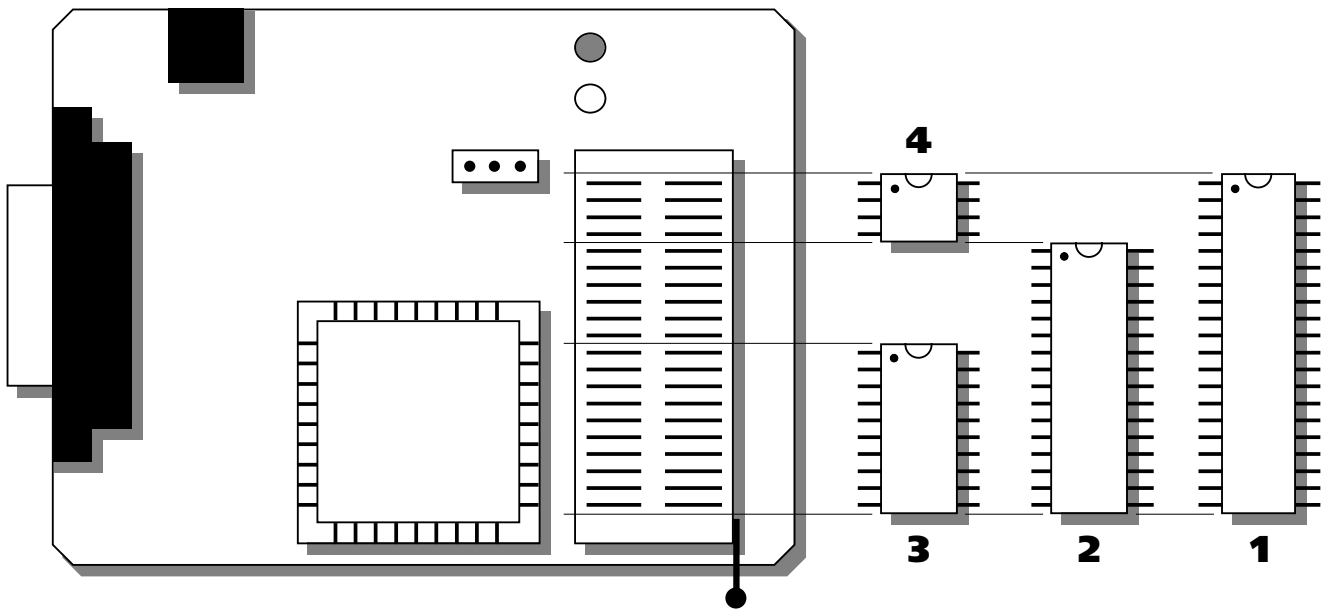

### Device Position & Orientation Key

- 1 MICROCONTROLLER (40 pin - 0.6" pitch)  
e.g. 89C51, 87C52
- 2 FLASH (32 pin - 0.6" pitch)  
e.g. AT29C512, AT29C010  
PARALLEL EEPROM (32 pin)  
e.g. 28C512
- 3 MICROCONTROLLER (20 pin - 0.3" pitch)  
e.g. AT89C2051, AT90S1200
- 4 SERIAL EEPROM (8 pin - 0.3" pitch)  
e.g. AT24C08, AT25010
- 5 SERIAL CONFIGURATORS (8 pin - 0.3" pitch)  
e.g. 17C256

## Device Support

### ATMEL

Type	Device
FPGA Configurator	<b>AT17C65</b> DIP8
FPGA Configurator	<b>AT17C128</b> DIP8
FPGA Configurator	<b>AT17C256</b> DIP8
FPGA Configurator	<b>AT17C65</b> SOIC20/PLCC
FPGA Configurator	<b>AT17C128</b> SOIC20/PLCC
FPGA Configurator	<b>AT17C256</b> SOIC20/PLCC
Flash Memory	* <b>AT29C256</b> -DIL28 NEED
Flash Memory	<b>AT29C256</b> -PLCC32
Flash Memory	* <b>AT29C257</b> -PLCC32
Flash Memory	<b>AT29C512</b>
Flash Memory	<b>AT29C010</b>
Flash Memory	<b>AT29C010A</b>
Flash Memory	<b>AT29C020</b>
Flash Memory	<b>AT29C040A</b>
Flash Memory	<b>AT49F010</b>
Flash Memory	<b>AT49F020</b>
Flash Memory	<b>AT49F040</b>
Serial EEPROM	<b>AT24C01</b>
Serial EEPROM	<b>AT24C01A</b>
Serial EEPROM	<b>AT24C02</b>
Serial EEPROM	<b>AT24C04</b>
Serial EEPROM	<b>AT24C08</b>
Serial EEPROM	<b>AT24C16</b>
Serial EEPROM	<b>AT24C16A</b>
Serial EEPROM	<b>AT24C32</b>
Serial EEPROM	<b>AT24C64</b>
Serial EEPROM	<b>AT24C32</b> SOIC14
Serial EEPROM	<b>AT24C64</b> SOIC14
Serial EEPROM	<b>AT25010</b>
Serial EEPROM	<b>AT25020</b>
Serial EEPROM	<b>AT25040</b>
Serial EEPROM	<b>AT93C46</b>
Serial EEPROM	<b>AT93C56</b>
Serial EEPROM	<b>AT93C57</b>
Serial EEPROM	<b>AT93C66</b>
AVR Microcontroller	<b>AT90S1200</b>
AVR Microcontroller	<b>AT90S1200A</b>
AVR Microcontroller	<b>AT90S2313</b>
AVR Microcontroller	<b>AT90S8515-SPI<sup>†</sup></b>
AVR Microcontroller	<b>AT90S4414-SPI<sup>†</sup></b>

89C Microcontroller	<b>AT89C51</b>
89C Microcontroller	<b>AT89C52</b>
89C Microcontroller	<b>AT89C55</b>
89C Microcontroller	<b>AT89LV51</b>
89C Microcontroller	<b>AT89LV52</b>
89C Microcontroller	<b>AT89LV55</b>
89C Microcontroller	<b>AT89C51-xxxx-5</b>
89C Microcontroller	<b>AT89C52-xxxx-5</b>
89C Microcontroller	<b>AT89C55-xxxx-5</b>
89C Microcontroller	<b>AT89LV51-xxxx-5</b>
89C Microcontroller	<b>AT89LV52-xxxx-5</b>
89C Microcontroller	<b>AT89LV55-xxxx-5</b>
89C Microcontroller	<b>AT87F51</b>
89C Microcontroller	<b>AT87F52</b>
89C Microcontroller	<b>AT89C1051</b>
89C Microcontroller	<b>AT89C1051U</b>
89C Microcontroller	<b>AT89C2051</b>
89C Microcontroller	<b>AT89C4051</b>
89S Microcontroller	<b>AT89S8252</b>
89S Microcontroller	<b>AT89S53</b>
89S Microcontroller	<b>AT89LS8252</b>
89S Microcontroller	<b>AT89LS53</b>
EEPROM Memory	<b>AT28C010</b> -DIL32
EEPROM Memory	<b>AT28C010E</b> -DIL32
EEPROM Memory	<b>AT28C010</b> -PLCC32
EEPROM Memory	<b>AT28C010E</b> -PLCC32
EEPROM Memory	<b>AT28C16</b> -PLCC32
EEPROM Memory	<b>AT28C16E</b> -PLCC32
EEPROM Memory	* <b>AT28C17</b> -PLCC32
EEPROM Memory	<b>AT28C17E</b> -PLCC32
EEPROM Memory	* <b>AT28C64</b> -PLCC32
EEPROM Memory	* <b>AT28C64E</b> -PLCC32
EEPROM Memory	* <b>AT28C64X</b> -PLCC32
EEPROM Memory	* <b>AT28C64B</b> -PLCC32
EEPROM Memory	* <b>AT28HC64B</b> -PLCC32
EEPROM Memory	* <b>AT28C256</b> -PLCC32
EEPROM Memory	* <b>AT28HC256</b> -PLCC32
EEPROM Memory	* <b>AT28C256E</b> -PLCC32
EEPROM Memory	<b>AT28C040</b> -44PLCC

\* **Please note:** The following 28-pin FLASH & EEPROM devices can only be supported in PLCC-32 package. The DIL-28 package can not be supported.

† Only Serial (ISP) programming mode is supported



## Device Support continued

### DALLAS

Type	Device
Microcontroller	<b>DS87C520</b>

### INTEL

Type	Device
Microcontroller	<b>80C251SB</b>
Microcontroller	<b>87C251SB</b>
Microcontroller	<b>D87C51-2</b>
Microcontroller	<b>D87C51</b>
Microcontroller	<b>D87C51</b> OTP
Microcontroller	<b>D87C51BH</b> OTP
Microcontroller	<b>D87C52</b>
Microcontroller	<b>D87C52</b> OTP
Microcontroller	<b>D87C52BH</b>
Microcontroller	<b>D87C51FA</b>
Microcontroller	<b>D87C51FA</b> OTP
Microcontroller	<b>MR87C51/B</b>
Microcontroller	<b>D87C51FB</b>
Microcontroller	<b>D87C51FB</b> OTP
Microcontroller	<b>D87C54</b> OTP
Microcontroller	<b>D87C51B</b> OTP

### PHILIPS/SIGNETICS

Type	Device
Microcontroller	<b>SC87C51</b>
Microcontroller	<b>SC87C51</b> OTP
Microcontroller	<b>SC87C52</b> OTP
Microcontroller	<b>S87C51FA</b>
Microcontroller	<b>S87C51FB</b>
Microcontroller	<b>S87C51FC</b>
Microcontroller	<b>87C52EBPN</b> OTP
Microcontroller	<b>87C52EPFFA</b>
Microcontroller	<b>S87C51CCN40</b> OTP
Microcontroller	<b>S87C51 FB-4F40</b> OTP
Microcontroller	<b>S87C51CCF40</b> OTP

### TEMIC

Type	Device
Microcontroller	<b>87C251SB</b>

## 8051 Support Products Guide

Order code	Description
<b>Programming Systems</b>	
AT-89C-2K-ST	Atmel 89C Microcontroller Starter System (Includes PK51-2K)
AT-89C-8K-DV	Atmel 89C Microcontroller Family Development System (Includes Keil PK51-8K)
MPW-PLUS	Micro-Pro Professional Device Programming System
EQ-8051-ST1	Flash 8051 Professional Starter System
UISP-S3-SYS	Micro-ISP Serial Programming System for the Atmel 89S/90S Microcontroller Families
AT-89S-ISP-TR-2K	Integrated 89S Microcontroller Training System (2K code)
AT-89S-ISP-TR-8K	Integrated 89S Microcontroller Training System (8K code)
AT-89S-ISP-SYS	ISP Programming System for the Atmel 89S Microcontroller Family
AT-89S-ISP-DV-8K	ISP Development System for the Atmel 89S Microcontroller Family (Includes Keil PK51-8K)
<b>Evaluation/ OEM Modules</b>	
AT-89C-X051-DEMO	Atmel 89C1051/2051 Credit Card Demo Module
AT-89C-X051-OEM	Atmel 89C1051/2051 OEM Module
EVALU8R-1P	Universal Microcontroller Evaluation Module
OEM-UC-20/40	Universal 8051/AVR Microcontroller OEM Module
<b>Package Adaptors</b>	
AD-PLCC44-A	Package Adaptor - PLCC-44 to DIL-40 (for programming/package conversion)
AD-DIL40-PLCC44-A	Package Adaptor - PLCC44 to DIL-40 (for emulation/package conversion)
AD-TQFP44-A	Programming adaptor - 44-pin TQFP to 40-pin DIL
AD-SOIC20-A	SOIC-20 to DIL-20 Adaptor Module
AD-8051-ICPP	In-Circuit Re-Programming Adaptor for the Atmel 89C & 89S Microcontroller Families
SS-89S8252-P	Atmel 89S8252 ISP 8051 Socket-Stealer Module (DIL-40)
SS-89S8252-J	Atmel 89S8252 ISP 8051 Socket-Stealer Module (PLCC-44)
<b>Keil Development Language Tools</b>	
PK51-2K	"Keil PK51 Lite - 2K C Compiler, Assembler & Software Simulator"
PK51-8K-UPG	Software Upgrade from PK51 Lite (2K) to PK51-8K version
PK51-8K-FULL	Software Upgrade from PK51-8K to Full version
PK51-MANUALS	"Keil Manual Set for PK51 (C51, A51 & Utilities)"
<b>Literature</b>	
CD-AT98	Atmel CD-ROM Data Book
DB-8051-981	Atmel 8051 Microcontroller Data Book
<b>Miscellaneous</b>	
LCD/KPD-V1	Intelligent LCD/Keypad OEM Module (RS-232 / 1K EEPROM)
<b>Memory Emulation Products</b>	
ICEPROM512K-80	icePROM EPROM/ Flash Emulation System
PLCC32 HEAD	icePROM 32 pin PLCC Adaptor
DIP40 HEAD	icePROM 40 pin DIP Adaptor

## AVR Support Products Guide

Order code	Description
<b>PROGRAMMING SYSTEMS</b>	
AVR2-ST	Professional AVR Microcontroller Starter System
AVR1-8K-DV	Professional AVR Microcontroller Development System
AVR1-820K	Atmel AT90S1200/AT90S23x3 AVR Microcontroller Starter Kit
MPW-PLUS	Micro-Pro Professional Device Programming System
UISP-S3-SYS	Micro-ISP Series III Professional Serial Programming System
UISP-UPG1	Micro-ISP Upgrade: Atmel ATmega programming support
ACT-UPG1	Activ8r Upgrade: Atmel ATmega programming support
UISP-EXP1	Low Voltage (+3V) In-System Programming (ISP) Expansion Module
<b>EVALUATION/OEM MODULES</b>	
OEM-UC-20/40	Universal 8051/AVR Microcontroller OEM Module
EVALU8R-1P	Evalu8r - Universal 8051/AVR Microcontroller Evaluation Module
<b>PACKAGE ADAPTORS ETC.</b>	
AD-PLCC44-A	Programming adaptor - 44-pin PLCC to DIL-40
AD-DIL40-PLCC44-A	Emulation adaptor - 44-pin PLCC on target system to 40-pin DIL
AD-SOIC20-A	Microcontroller Programming adaptor - 20-pin SOIC to 20-pin DIL
AD-SOIC8-A	Microcontroller Programming adaptor - 8-pin SOIC to 8-pin DIL
AD-8535-A	Parallel programming adaptor - Atmel AT90S8535/AT90S4434 (40-pin DIL)
AD-TQFP44-A	Programming adaptor - 44-pin TQFP to 40-pin DIL
SS-90S8515-P	ISP Socket Stealer Module fitted with Atmel AT90S8515 microcontroller (DIL)
SS-90S8515-J	ISP Socket Stealer Module fitted with Atmel AT90S8515 microcontroller (PLCC)
<b>AVR BASIC Programming Language</b>	
AVR-BAS-LITE	AVR BASIC LITE Version (1K bytes - AT90S1200 support only)
AVR-BAS-8K	AVR BASIC 8K Version (8K bytes - All AVR derivatives supported)
AVR-BAS-FULL	AVR BASIC Full Version (8K bytes - All AVR derivatives supported)
AVR-BAS-8KF	AVR BASIC 8K to FULL version upgrade
<b>IAR AT90S Language Tools</b>	
EWA90BAS-EE	"IAR Baseline Tool Set" - C compiler, assembler, debugger (8K code limit)
EWA90	"IAR Full AT90S Version" - C compiler, assembler, debugger (unrestricted code)
<b>DO-BOX (Dynamically Optimised BASIC Box) + Accessories</b>	
DOBOX-ST1	DO-BOX Starter System 1
DOBOX-DV1	DO-BOX Development System 1
DOBOX-MOD1	DO-BOX Module 1
DOBOX-PM1	DO-BOX Prototyping Module
DOBOX-AM1	DO-BOX Applications Module 1
<b>LITERATURE</b>	
CD-AT98	Atmel CD-ROM Databook 1998
DB-AVR-981	Atmel AVR Microcontroller Data Book (Paper format)
MAN-AVRBAS-REF	AVR BASIC Reference Guide
MAN-AVRBAS-GS	AVR BASIC Getting Started Guide
<b>MISCELLANEOUS</b>	
CAB-SER1	PC Serial Cable Adaptor Kit (9W-25W & 25W-9W)
CAB-PAR25MM	PC Parallel Cable (25W to 25W M/M 2M)

## Miscellaneous Accessories

### Adaptors

	AD-PLCC44-A	AD-SOIC20-A	AD-SOIC8-A	AD-TQFP44-A
<b>Atmel AVR microcontrollers</b>				
AT90S1200	X	✓	X	X
AT90S1200A	X	✓	X	X
AT90S2323	X	X	✓	X
AT90S2343	X	X	✓	X
AT90S4414	✓	X	X	✓
AT90S8515	✓	X	X	✓
AT90S4434	✓	X	X	X
AT90S8535	✓	X	X	X
<b>Atmel 8051 microcontrollers</b>				
AT89C1051	X	✓	X	X
AT89C1051U	X	✓	X	X
AT89C2051	X	✓	X	X
AT89C4051	X	✓	X	X
AT89C51	✓	X	X	✓
AT89C52	✓	X	X	✓
AT89C55	✓	X	X	✓
AT89S8252	✓	X	X	✓
AT89S53	✓	X	X	✓

44-pin PLCC adaptor illustrated

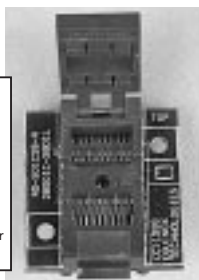
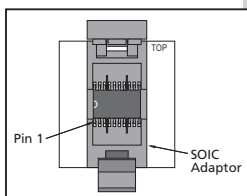
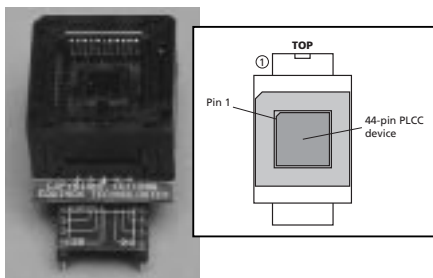

20-pin SOIC adaptor illustrated

### Cables

#### CAB-PAR25MM

PC Parallel Cable (25W to 25W M/M 2M)

### Power Supplies

#### PSU-15250-UK, PSU-15250-US, PSU-15250-EU

Mains Power Supply Adaptor 15V@250mA

Suitable for use with : Micro-PRO Programmer

Activ8r Programmer



Equinox Technologies UK Limited reserves the right to change any information contained within this manual without prior notice. E&OE

Terms and product names contained in this document may be trademarks of others.