

SMD Power Inductor CDRH58D14R

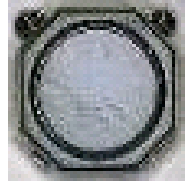

Halogen
Free



Description

- Ferrite drum core construction.
- Magnetically shielded.
- L × W × H: 6.0 × 6.0 × 1.5 mm Max.
- Product weight: 0.16g(Ref.)
- Moisture Sensitivity Level: 1
- RoHS compliance.
- Halogen Free available.

Environmental Data

- Operating temperature range: -40°C~+105°C (including coil's self temperature rise)
- Storage temperature range: -40°C~+105°C
- Solder reflow temperature: 260 °C peak.

Packaging

- Carrier tape and reel packaging
- 13.0" diameter reel
- 3000pcs per reel

Applications

- Ideally used in Hard Disk.

Dimension - [mm]

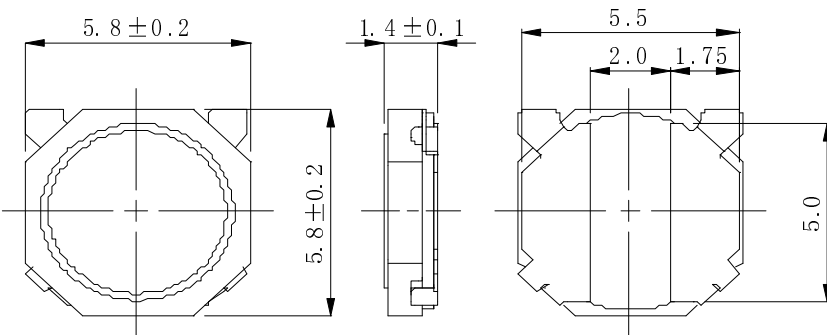

Land pattern and Schematics - [mm]

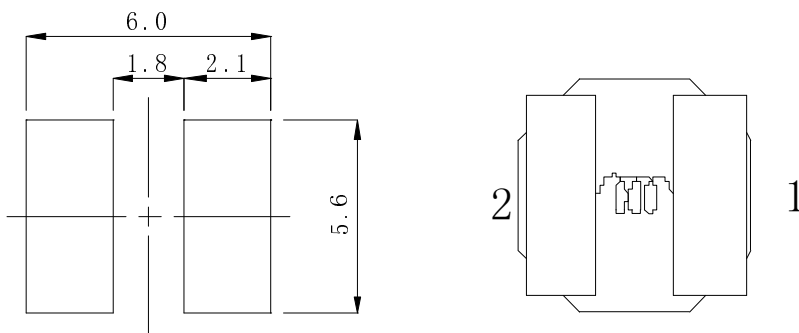

SMD Power Inductor

CDRH58D14R



Electrical Characteristics

Part No.	Stamp	Inductance (μ H) [Within] ※1	D.C.R. (m Ω) [Within] (at 20°C)	Saturation current (A) ※2	Temperature rise current (A) ※3
CDRH58D14RHF-1R0NC	A	1.0 \pm 30%	16 \pm 25%	3.15	4.62
CDRH58D14RHF-1R4NC	B	1.4 \pm 30%	20 \pm 25%	2.55	4.15
CDRH58D14RHF-2R0NC	C	2.0 \pm 30%	25 \pm 25%	2.13	3.75
CDRH58D14RHF-2R7NC	D	2.7 \pm 30%	30 \pm 25%	1.87	3.35
CDRH58D14RHF-3R3NC	E	3.3 \pm 30%	44 \pm 25%	1.70	2.84
CDRH58D14RHF-4R7NC	F	4.7 \pm 30%	50 \pm 25%	1.40	2.50
CDRH58D14RHF-6R8MC	G	6.8 \pm 20%	75 \pm 25%	1.16	2.06
CDRH58D14RHF-100MC	H	10 \pm 20%	108 \pm 20%	0.96	1.72
CDRH58D14RHF-150MC	J	15 \pm 20%	159 \pm 20%	0.78	1.47
CDRH58D14RHF-220MC	K	22 \pm 20%	263 \pm 20%	0.65	1.09
CDRH58D14RHF-330MC	L	33 \pm 20%	387 \pm 20%	0.54	0.88
CDRH58D14RHF-470MC	M	47 \pm 20%	531 \pm 20%	0.45	0.75

※1 Measuring condition Inductance at 100kHz .

※2 Saturation current: The value of DC current when the inductance decreases to 70% of its nominal.

※3 Temperature rise current: The value of DC current when the temperature rise is $\Delta T=40^{\circ}\text{C}$ ($T_a=20^{\circ}\text{C}$).

SMD Power Inductor CDRH58D14R

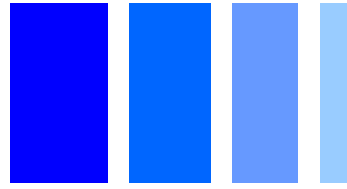

Saturation Current & Temperature Rise Graph

— L (20°C) — L (105°C) — ΔT

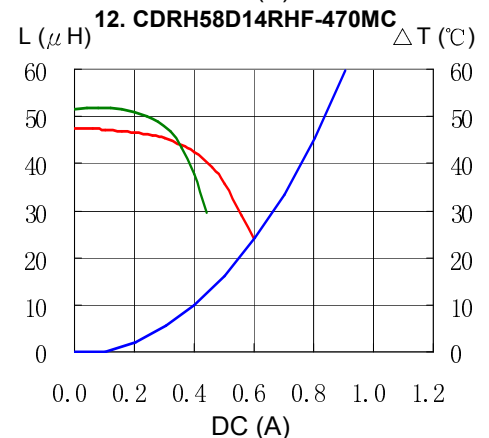
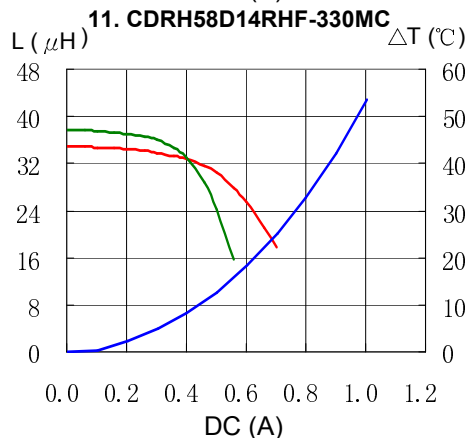
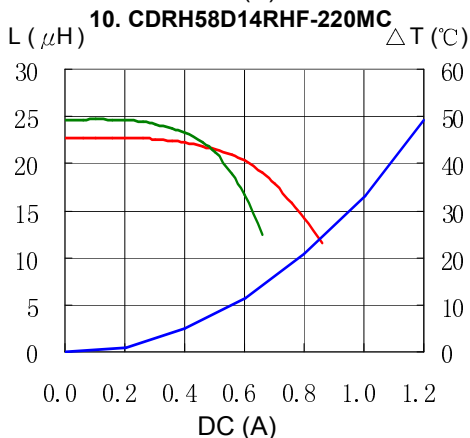
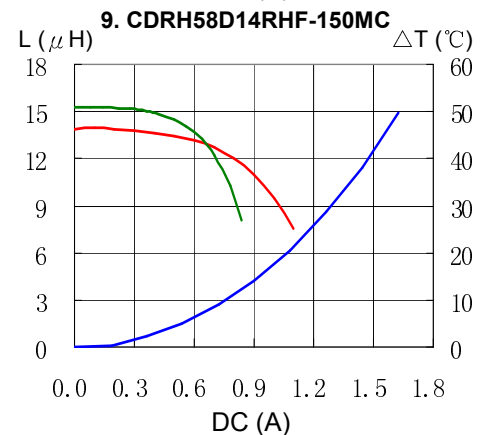
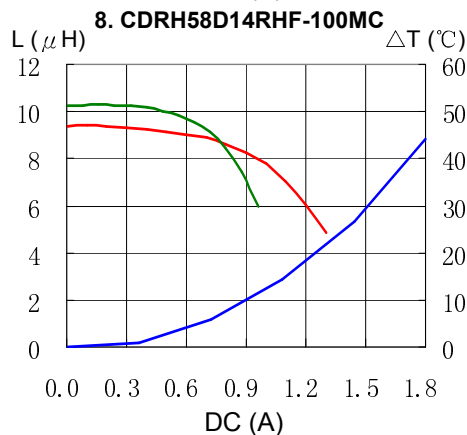
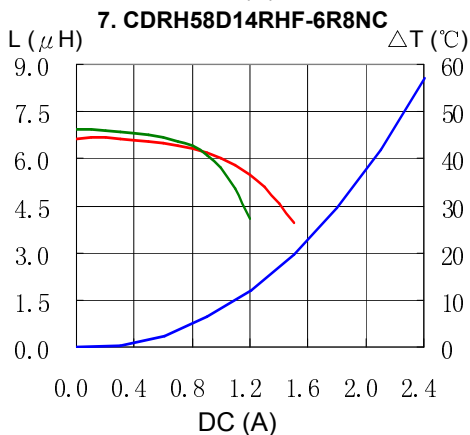
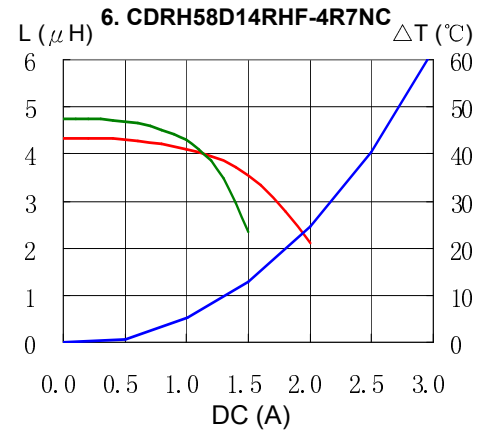
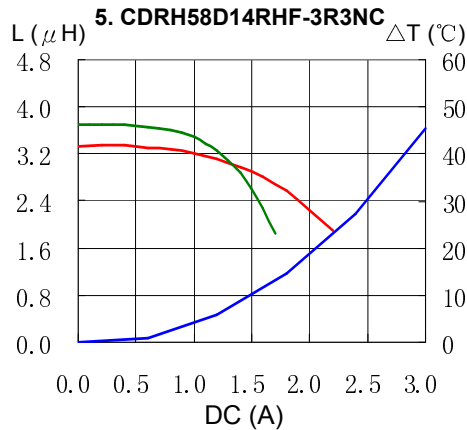
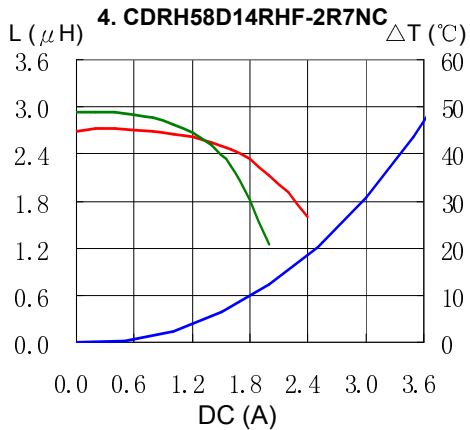
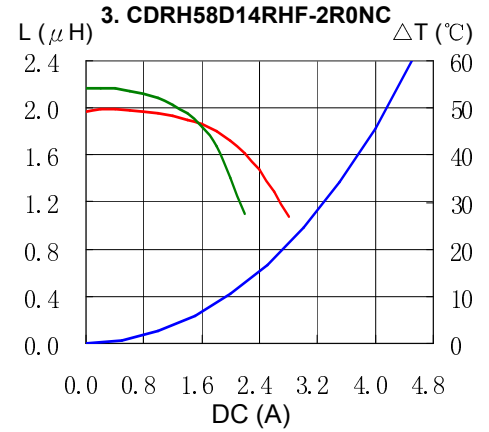
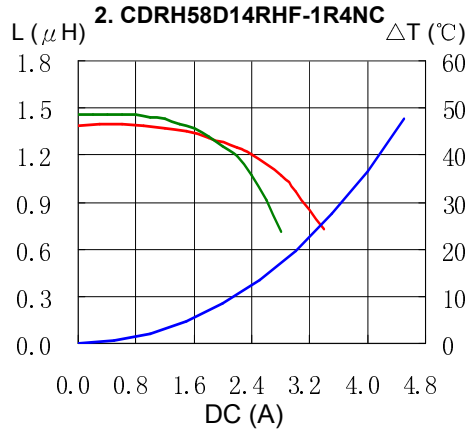
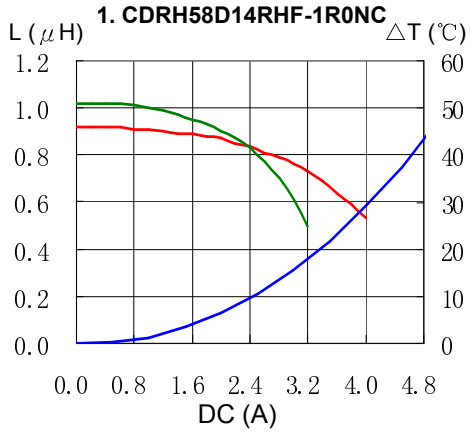

SMD Power Inductor CDRH58D14R



Solder Reflow Condition

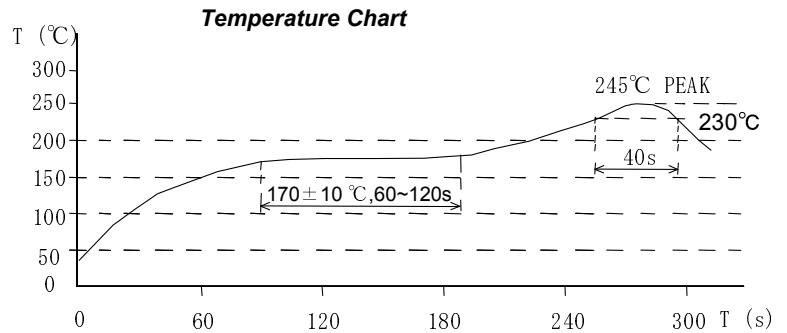
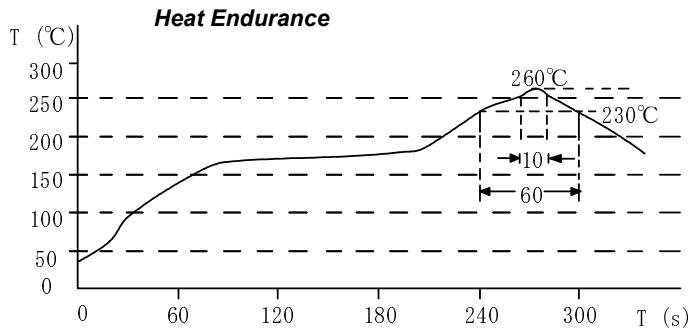

Please refer to the sales offices on our website - <http://www.sumida.com>

Hong Kong

Tel.+852-2880-6688

FAX.+852-2565-9600

sales@hk.sumida.com

Tokyo

Tel.+81-3-5202-7112

FAX.+81-3-5202-7105

sales@jp.sumida.com

Chicago

Tel.+1-847-545-6700

FAX. +1-847-545-6720

sales@us.sumida.com

Shanghai

Tel.+86-021-5836-3299

FAX.+86-021-5836-3266

shanghai.sales@cn.sumida.com

Seoul

Tel.+82-2-6237-0777

FAX.+82-2-6237-0778

sales@kr.sumida.com

Obernzell

Tel.+49-8591-937-0

FAX. +49-8591-937-103

contact@sumida-eu.com

Shenzhen

Tel.+86-755-8291-0228

FAX.+86-755-8291-0338

shenzhen.sales@cn.sumida.com

Singapore

Tel.+65-6296-3388

FAX.+65-6296-3390

sales@sg.sumida.com

Neumarkt

Tel.+49-9181-4509-110

FAX. +49-9181-4509-310

infocomp@eu.sumida.com

Taipei

Tel.+886-2-8751-2737

FAX.+886-2-8751-2738

sales@tw.sumida.com

San Jose

Tel.+1-408-3219660

FAX.+1-408-321-9308

sales@us.sumida.com