



# 500mA SmartOR™ DUAL REGULATOR WITH V<sub>AUX</sub> SWITCH

## Features

- 8-pin Power SOIC package
- Continuous 3.3V output from three inputs
- Complete Power Management solution
- V<sub>CC</sub>, V<sub>SBY</sub> Regulator supplies 500mA output
- Built-in hysteresis when selecting input supplies
- Integrated switch has very low R<sub>DS(ON)</sub> 0.12Ω (typ.)
- Large Bypass Capacitors on inputs not required

## Applications

- PCI adapter cards with Wake-On-LAN
- Network Interface Cards (NICs)
- Multiple Power Systems
- Systems with Standby Capabilities

## Product Description

The CMPWR300 is a dual input regulator with V<sub>AUX</sub> switch capable of delivering 3.3V/500mA continuously. The output power is provided from three independent input voltage sources on a prioritized basis. Power is always taken in priority using the following order V<sub>CC</sub>, V<sub>SBY</sub>, and V<sub>AUX</sub>.

When V<sub>CC</sub> (5V) or V<sub>SBY</sub> is present, the device automatically enables the regulator and produces a stable 3.3V output at V<sub>OUT</sub>. When only V<sub>AUX</sub> (3.3V) is present, the device provides a low impedance direct connection (0.12Ω typ.) from V<sub>AUX</sub> to V<sub>OUT</sub>.

All the necessary control circuitry needed to provide a smooth and automatic transition between all three supplies has been incorporated. This allows both V<sub>CC</sub> and V<sub>SBY</sub> to be dynamically switched without loss of output voltage.

## Pin Diagram

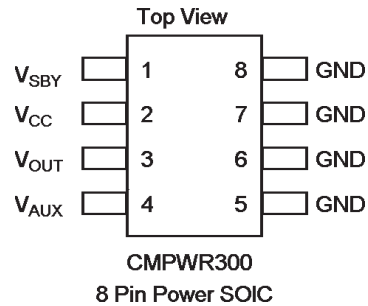

## Typical Application Circuit

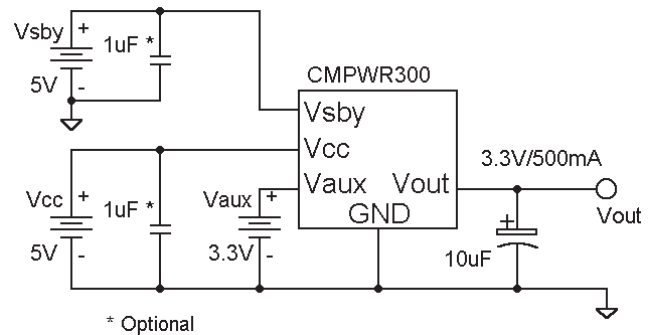

## Simplified Electrical Schematic

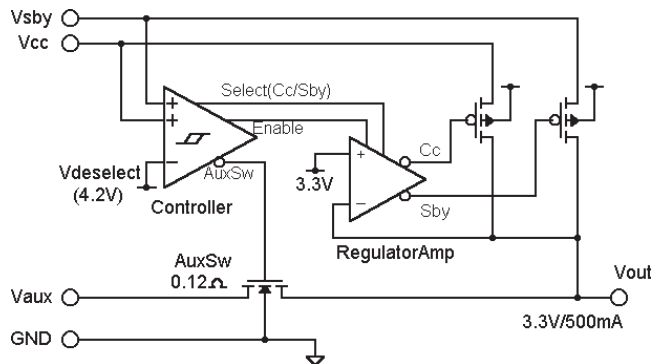

STANDARD PART ORDERING INFORMATION		
Package		Ordering Part Number
Pins	Style	Part Marking
8	SOIC Power	CMPWR300SA

When placing an order please specify desired shipping: Tubes or Tape & Reel.

**ABSOLUTE MAXIMUM RATINGS**

Parameter	Rating	Unit
ESD Protection (HBM)	2000	V
V <sub>CC</sub> V <sub>SBY</sub> Input Voltage	+6.0, Gnd -0.5	V
V <sub>AUX</sub> Input Voltage	+4.0, Gnd -0.5	V
Storage Temperature Range	-40 to +150	
Operating Ambient	0 to +70	°C
Operating Junction	0 to +125	
Power Dissipation: <sup>Note 1</sup>	1.0	W

**OPERATING CONDITIONS**

Parameter	Range	Unit
V <sub>CC</sub> , V <sub>SBY</sub>	5.0 ± 0.25	V
V <sub>AUX</sub>	3.3 ± 0.3	V
Temperature (Ambient)	0 to +70	°C
Load Current	0 to 500	mA
C <sub>EXT</sub>	10 ± 10%	μF

**ELECTRICAL OPERATING CHARACTERISTICS**  
(over operating conditions unless specified otherwise)

Symbol	Parameter	Conditions	MIN	TYP	MAX	UNIT
V <sub>OUT</sub>	Regulator Output Voltage	500mA > I <sub>LOAD</sub> > 0mA	3.135	3.30	3.465	V
I <sub>OUT</sub>	Regulator Output Current		500	800		mA
V <sub>RLOAD</sub>	Load Regulation	V <sub>CC</sub> = 5V, I <sub>LOAD</sub> = 50mA to 500mA		20		mV
V <sub>RLINE</sub>	Line Regulation	V <sub>CC</sub> = 4.5V to 5.5V, I <sub>LOAD</sub> = 5mA		2		mV
V <sub>CCSEL</sub>	V <sub>CC</sub> Select Voltage			4.50	4.60	
V <sub>CCDES</sub>	V <sub>CC</sub> Deselect Voltage	V <sub>SBY</sub> > V <sub>SBYDES</sub> or V <sub>AUX</sub> present	3.90	4.20		V
V <sub>SBYSEL</sub>	V <sub>SBY</sub> Select Voltage	V <sub>CC</sub> < V <sub>CCDES</sub>		4.50	4.60	
V <sub>SBYDES</sub>	V <sub>SBY</sub> Deselect Voltage	V <sub>AUX</sub> present	3.90	4.20		
V <sub>HYST</sub>	Hysteresis Voltage: <sup>Note 2</sup>	Applies to V <sub>CC</sub> and V <sub>SBY</sub> selection		0.30		
R <sub>SW</sub>	Auxiliary Switch Resistance	V <sub>CC</sub> /V <sub>SBY</sub> are deselected		0.12	0.2	Ω
I <sub>SC</sub>	Short Circuit Current	V <sub>CC</sub> /V <sub>SBY</sub> = 5V, V <sub>OUT</sub> = 0V		2000		mA
I <sub>RCC</sub>	V <sub>CC</sub> Pin Reverse Leakage	One supply input taken to ground				
I <sub>RSBY</sub>	V <sub>SBY</sub> Pin Reverse Leakage	while the others remain at normal		5	50	μA
I <sub>RAUX</sub>	V <sub>AUX</sub> Pin Reverse Leakage	voltage				
I <sub>CC</sub>	V <sub>CC</sub> Supply Current (when V <sub>CC</sub> is not present)	V <sub>CC</sub> > V <sub>CCSEL</sub> , I <sub>LOAD</sub> = 0mA V <sub>CCDES</sub> > V <sub>CC</sub> > V <sub>OUT</sub> V <sub>OUT</sub> > V <sub>CC</sub>		1.0 0.15 0.01	3.0 0.25 0.02	mA
I <sub>SBY</sub>	V <sub>SBY</sub> Supply Current (when V <sub>CC</sub> is not present)	V <sub>SBY</sub> > V <sub>SBYSEL</sub> , I <sub>LOAD</sub> = 0mA V <sub>SBYDES</sub> > V <sub>SBY</sub> > V <sub>OUT</sub> V <sub>OUT</sub> > V <sub>SBY</sub>		1.0 0.15 0.01	3.0 0.25 0.02	mA
I <sub>AUX</sub>	V <sub>AUX</sub> Supply Current	V <sub>CC</sub> or V <sub>SBY</sub> > V <sub>OUT</sub> V <sub>CC</sub> and V <sub>SBY</sub> < V <sub>OUT</sub>		0.05 0.2	0.1 0.4	mA
I <sub>GND</sub>	Ground Current: <sup>Note 3</sup>	Both V <sub>CC</sub> and V <sub>SBY</sub> are delection V <sub>CC</sub> /V <sub>SBY</sub> = 5V, I <sub>LOAD</sub> = 0mA V <sub>CC</sub> /V <sub>SBY</sub> = 5V, I <sub>LOAD</sub> = 500mA		0.15 1.0 1.2	0.30 3.0 3.5	mA

Note 1: The thermal resistance from junction to ambient ( $\theta_{JA}$ ) must be less than 55° C/W. This is typically achieved with 2 square inches of copper printed circuit board area connected to the GND pins for heat spreading, or equivalent.

Note 2: The hysteresis defines the maximum level of acceptable disturbance on V<sub>CC</sub> during switching.

Note 3: Ground current consists of controller current and regulator current if enabled.



**Interface Signals**

$V_{CC}$  is the primary power source which is given priority when present. If this connection is made within a few inches of the main input filter, a bypass capacitor may not be necessary. Otherwise a bypass filter capacitor in the range of 1 $\mu$ F to 10 $\mu$ F will ensure adequate filtering.

The voltage level on  $V_{CC}$  is compared to an internal threshold voltage to determine which power source is to be selected. In order to prevent regulator dropout from occurring, the threshold has been programmed to ensure  $V_{CC}$  is deselected prior to dropout, which prevents loss of output regulation when switching between  $V_{CC}$  and  $V_{SBY}$ . Typically the threshold is set to 4.2V. Once  $V_{CC}$  falls below this level, the output voltage is immediately derived from the auxiliary power source. To prevent chatter during this transition, the threshold has a built-in hysteresis of 300mV which results in only  $V_{CC}$  being selected once the voltage level exceeds 4.50V (typically).

$V_{SBY}$  is the standby 5V supply power source, which is given priority when  $V_{CC}$  is not present. The internal regulator will remain enabled until such time that  $V_{SBY}$  falls below the disable threshold level (4.2V typically). If the  $V_{SBY}$  connection is made within a few inches of the main input filter, a bypass capacitor may not be necessary. Otherwise a bypass filter capacitor in the range of 1 $\mu$ F to 10 $\mu$ F will ensure adequate filtering.

$V_{AUX}$  is the auxiliary low voltage power source. This supply is only used when neither the  $V_{CC}$  nor  $V_{SBY}$  is available. Under these conditions an internal switch is enabled and provides a very low impedance connection directly between  $V_{OUT}$  and  $V_{AUX}$ .

$V_{OUT}$  is the output voltage. Power is provided from the regulator or via the low impedance auxiliary switch. This output requires a capacitance of 10 $\mu$ F to ensure regulator stability and minimize the peak output disturbance during power supply changeover.

**GND** provides the reference for all voltages.

INTERFACE SIGNALS		
Pin	Symbol	Description
1	$V_{SBY}$	Standby supply voltage (5V) input for regulator when $V_{CC}$ falls below 4.2V.
2	$V_{CC}$	Primary supply voltage (5V) input for regulator.
3	$V_{OUT}$	Regulator voltage output (3.3V) regulator when either $V_{CC}$ or $V_{SBY}$ is present.
4	$V_{AUX}$	Auxiliary supply voltage (3.3V) input for low impedance switch.
5-8	GND	Reference for all voltages.



Typical DC Characteristics

Unless stated otherwise, all DC characteristics were measured at room temperature with a nominal V<sub>CC</sub> supply voltage of 5.0 volts and an output capacitance of 10µF.

Fig 1.1.

Line regulation of the regulator is shown here. At maximum rated load conditions (500mA), a 100mV drop in regulation occurs when the line voltage falls below 3.8V. For light load conditions (100mA), regulation is maintained for line voltages as low as 3.5V.

In normal operation the regulator is deselected at 4.2V, which ensures a regulation output drop of less than 100mV is maintained.

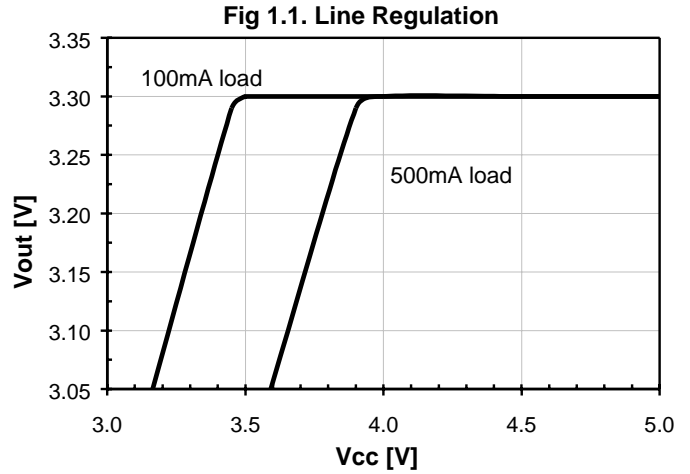

Fig 1.2.

Load regulation (pulse condition) performance is shown up to and beyond the rated load. A change in load from 10% to 100% of rated (50mA to 500mA) results in an output voltage change of about 20mV. This translates into an effective output impedance of less than 50mΩ.

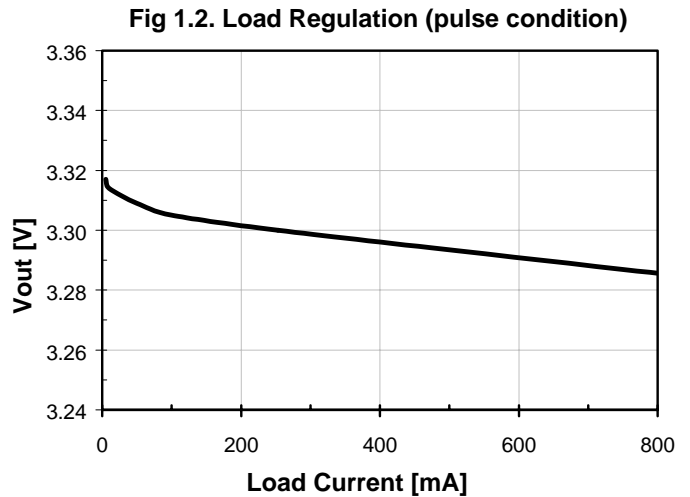
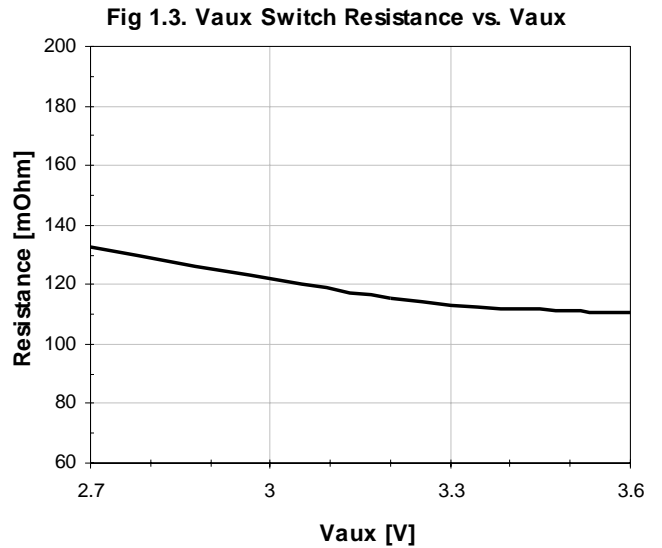

Fig 1.3.

V<sub>AUX</sub> Switch Resistance is shown across a broad range of V<sub>AUX</sub> supply level. From 2.7V and 3.6V, it only varies from about 130mΩ down to 110mΩ.



**Fig 1.4.**

Ground Current is shown across the entire range of load conditions. The ground current has minimal variation across the range of load conditions and shows only a slight increase at maximum load due to the current limit protection circuitry.

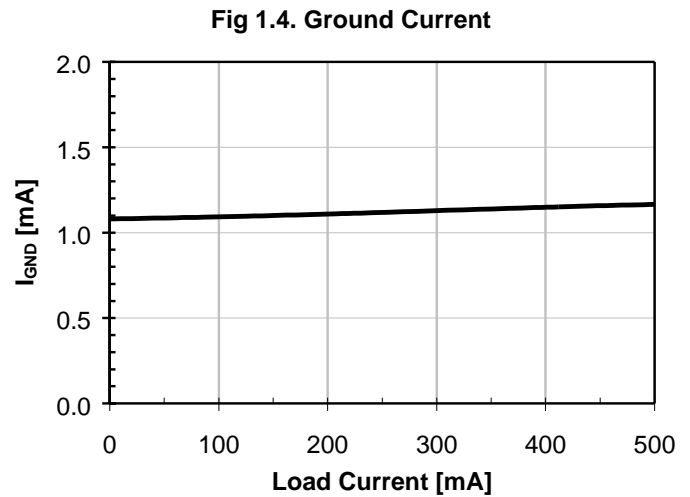
**Fig 1.5.**

$V_{CC}$  Supply Current of the device is shown across the entire  $V_{CC}$  range for both  $V_{AUX}$  present (3.3V) and absent (0V).

In the absence of  $V_{AUX}$ , the supply current remains fixed at approximately 1 mA when  $V_{CC}$  reaches the voltage level of about 2.5V. At this point the regulator is enabled and a supply current of 1.0mA is conducted.

When  $V_{AUX}$  is present, the  $V_{CC}$  supply current is less than 10uA until  $V_{CC}$  exceeds  $V_{AUX}$ , at which point  $V_{CC}$  then powers the controller (0.15mA). When  $V_{CC}$  reaches  $V_{SELECT}$  the regulator is enabled.

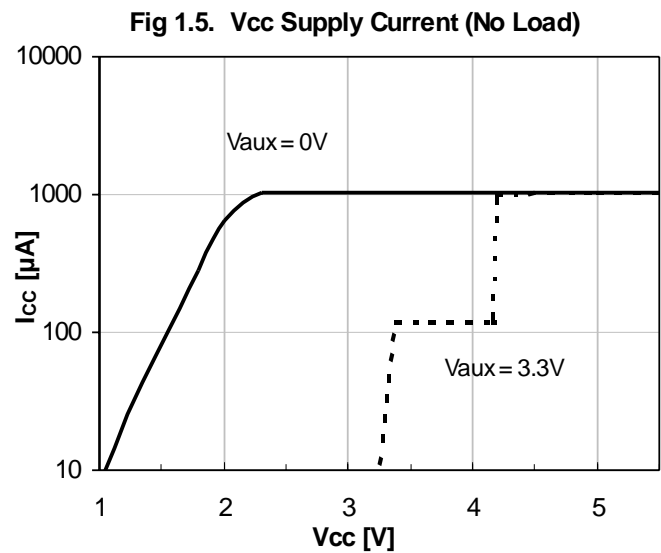



### Typical Transient Characteristics

The transient characterization test setup shown below includes the effective source impedance of the  $V_{CC}$  supply ( $R_s$ ). This was measured to be approximately  $0.2\Omega$ . It is recommended that this effective source impedance be no greater than  $0.25\Omega$  to ensure precise switching is maintained during  $V_{CC}$  selection and deselection.

Both the rise and fall times during  $V_{CC}$  power-up/down sequencing were controlled to be around 10 millisecond duration. This is considered to represent worst case conditions for most application circuits.

A maximum rated load current of 500mA was used during characterization, unless specified otherwise.

During a selection or deselection transition the DC load current is switching from  $V_{AUX}$  to  $V_{CC}$  and vice versa, or from  $V_{SBY}$  to  $V_{CC}$ . In addition to the normal load current there may also be an in-rush current for charging/discharging the load capacitor. The total current pulse being applied to either  $V_{AUX}$  or  $V_{CC}$  is equal to the sum of the dc load and the corresponding in-rush current. Transient currents in excess of one amp can readily occur for brief intervals when either supply commences to power the load.

The oscilloscope traces of  $V_{CC}$  power-up/down show the full bandwidth response at the  $V_{CC}$  and  $V_{OUT}$  pins under full load (500mA) conditions.

See Application note AP-211 for more details.

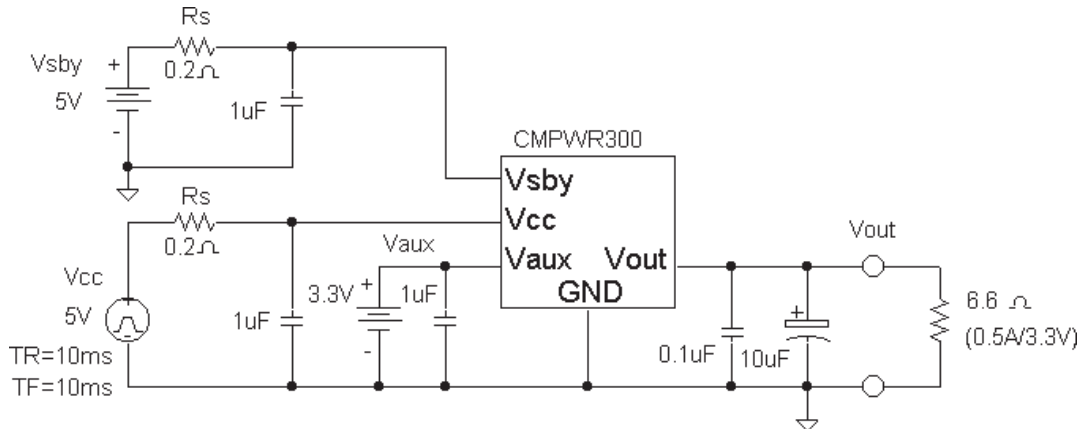

Transient Characterization Test Setup

#### Cold Start and Full Power Down (Fig 2.1 to 2.6)

Cold start power up and power down from  $V_{CC}$ ,  $V_{SBY}$  and  $V_{AUX}$ . The output voltage follows the input very smoothly with no disturbance. As soon as the  $V_{CC}$  or  $V_{SBY}$  input voltage reaches about 2V,  $V_{OUT}$  starts rising. It reaches 3.3V when  $V_{CC}$  or  $V_{SBY}$  equals 3.8V.  $V_{OUT}$  remains valid until  $V_{CC}$  or  $V_{SBY}$  drops below 3.8V.

#### $V_{CC}$ Power Changeover (Fig 2.7 to 2.12)

Power transitions between the main  $V_{CC}$  and the standby or the auxiliary sources under 375mA load. The transition between  $V_{CC}$  and  $V_{SBY}$  shows a small disturbance of 80mV on  $V_{OUT}$ .

Transitions between  $V_{CC}$  and  $V_{AUX}$  show a disturbance of about 120mV on  $V_{OUT}$ . During power up condition,  $V_{CC}$  experiences 100mV disturbance.

This is due to the in-rush current during the power switching. The built-in hysteresis of 300mV ensures the regulator remains turned on throughout the transient.

#### Load and Line Transient Response (Fig 2.13 to 2.16)

The load transient response shows a 5mA to 500mA step load with minimal disturbance on  $V_{OUT}$  of 80mV. An initial transient overshoot of 80mV occurs and the output settles to its final voltage within a few microseconds. The dc voltage disturbance on the output is approximately 25mV, which demonstrates the regulator output impedance of 50mV.

The line step response shows a small disturbance of 25mV on the output when  $V_{CC}$  steps from 4.5V to 5.5V. When falling from 5.5V to 4.5V, the output is almost unchanged



Typical Transient Characteristics - Cold Start and Full Power Down

Fig 2.1 V<sub>CC</sub> cold start

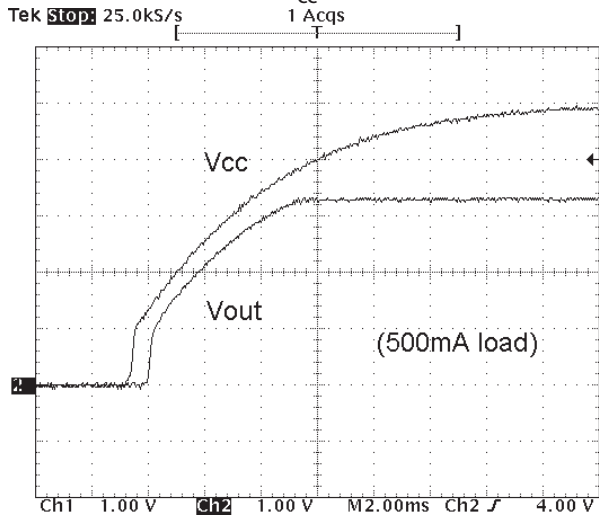

Fig 2.2 V<sub>CC</sub> full power down

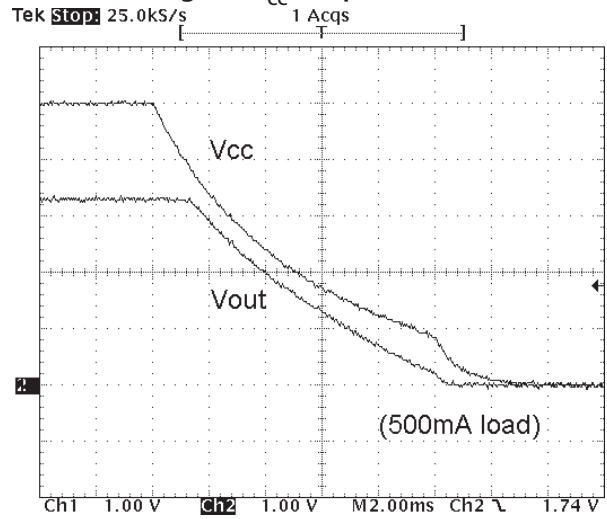

Fig 2.3 V<sub>SBY</sub> cold start

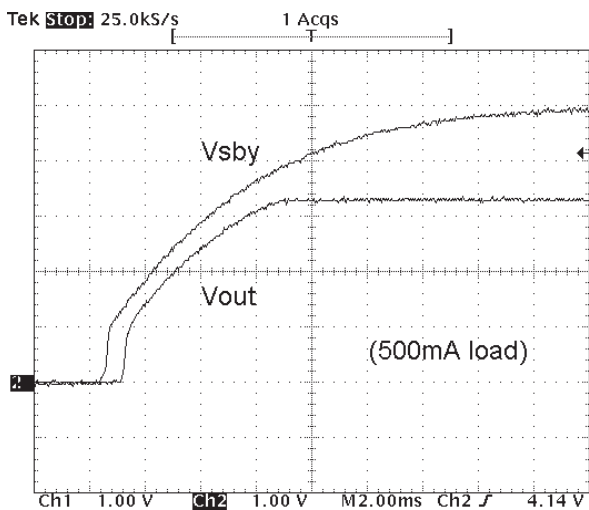

Fig 2.4 V<sub>SBY</sub> full power down

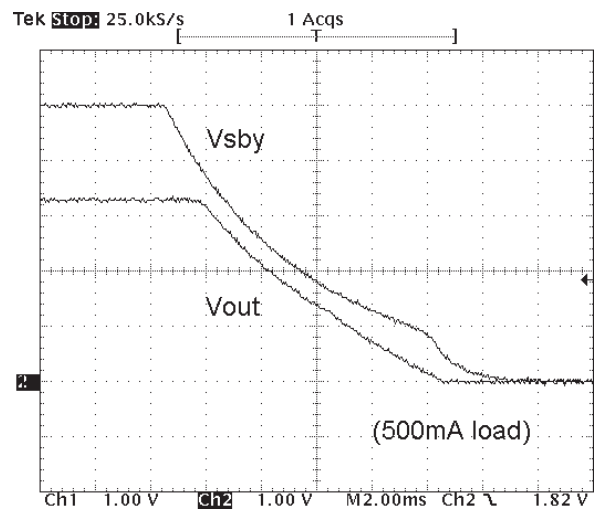

Fig 2.5 V<sub>AUX</sub> cold start

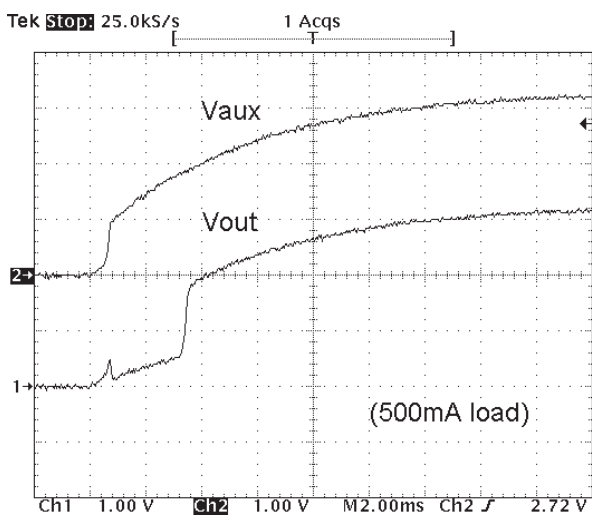
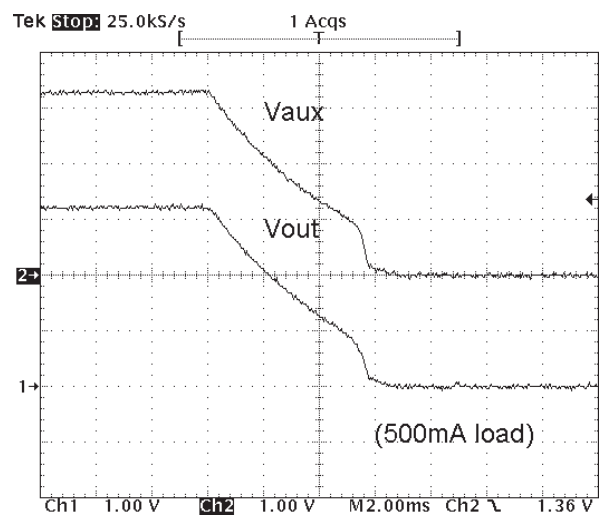

Fig 2.6 V<sub>AUX</sub> full power down





Typical Transient Characteristics - V<sub>CC</sub> Power Changeover

Fig 2.7 V<sub>CC</sub> power up (V<sub>SBY</sub> = 5V)

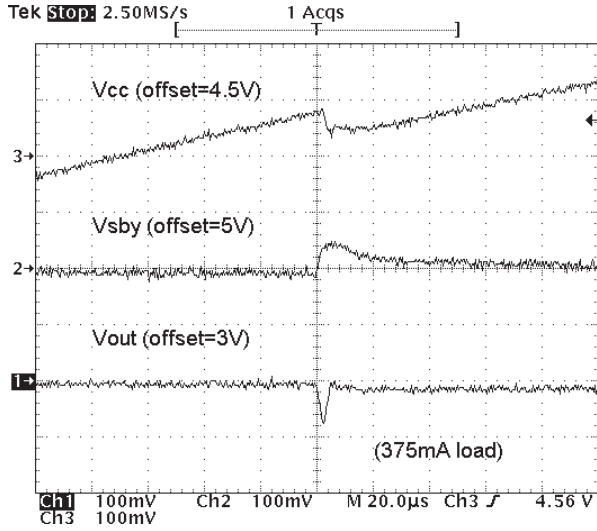

Fig 2.8 V<sub>CC</sub> power down (V<sub>SBY</sub> = 5V)

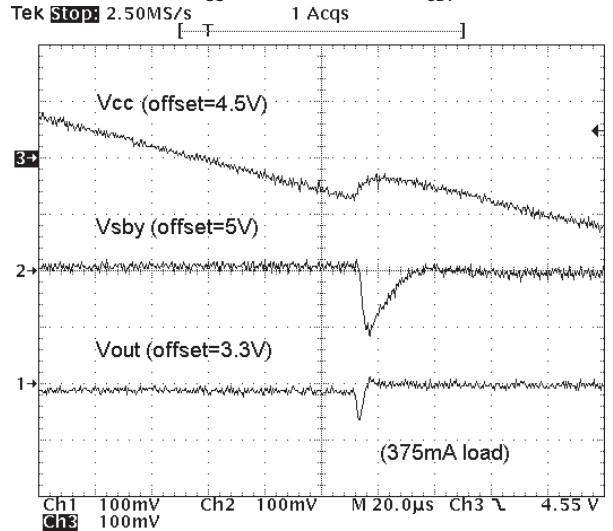

Fig 2.9 V<sub>CC</sub> power up (V<sub>AUX</sub> = 3.3V)

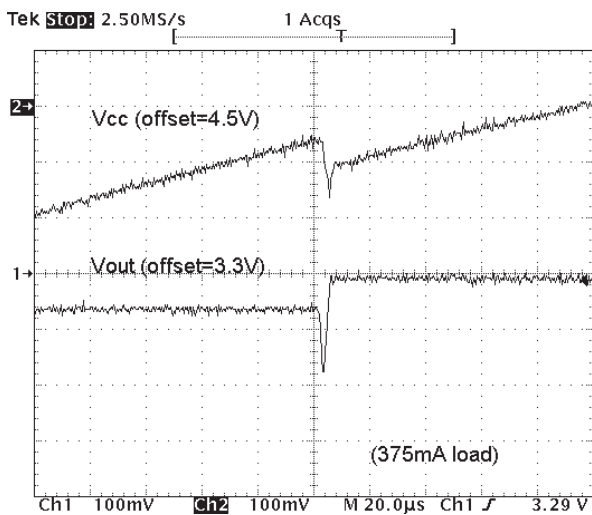

Fig 2.10 V<sub>CC</sub> power down (V<sub>AUX</sub> = 3.3V)

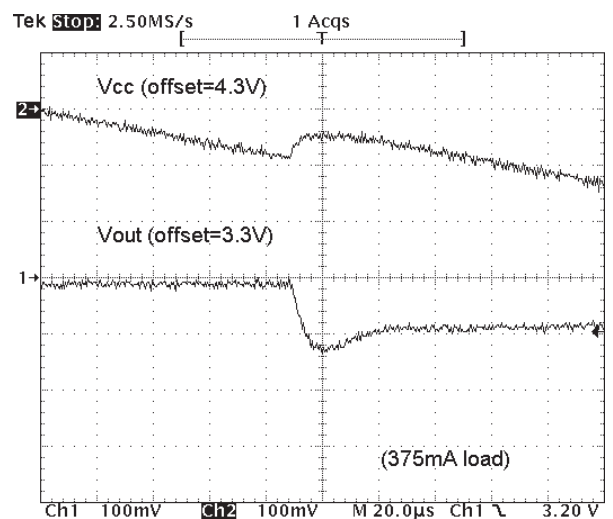

Fig 2.11 V<sub>CC</sub> power up (V<sub>AUX</sub> = 3.1V)

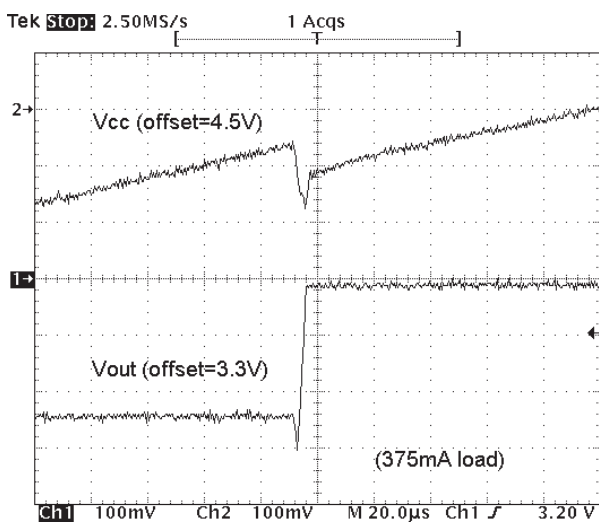
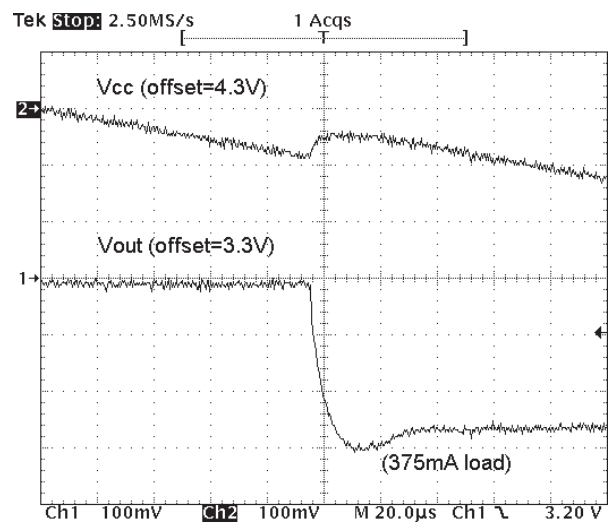

Fig 2.12 V<sub>CC</sub> power down (V<sub>AUX</sub> = 3.1V)







Typical Transient Characteristics - Load and Line Transient Response

Fig 2.13 V<sub>CC</sub> Load Transient Response Rising

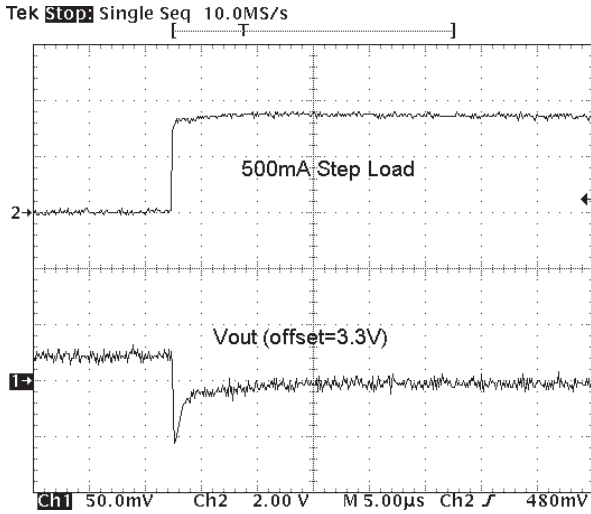

Fig 2.14 V<sub>CC</sub> Load Transient Response Falling

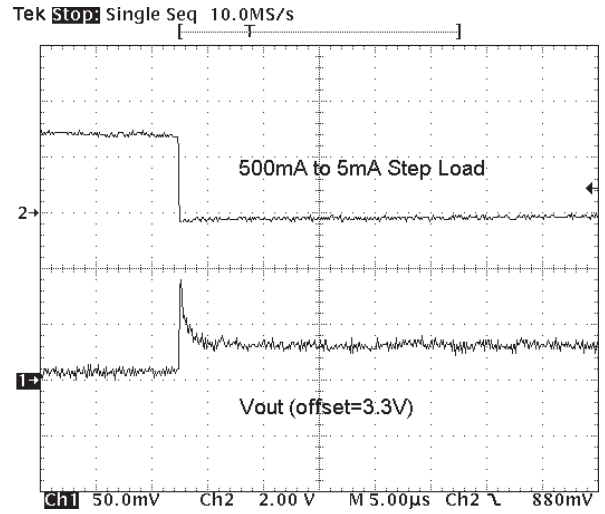

Fig 2.15 V<sub>CC</sub> Load Step Response Rising

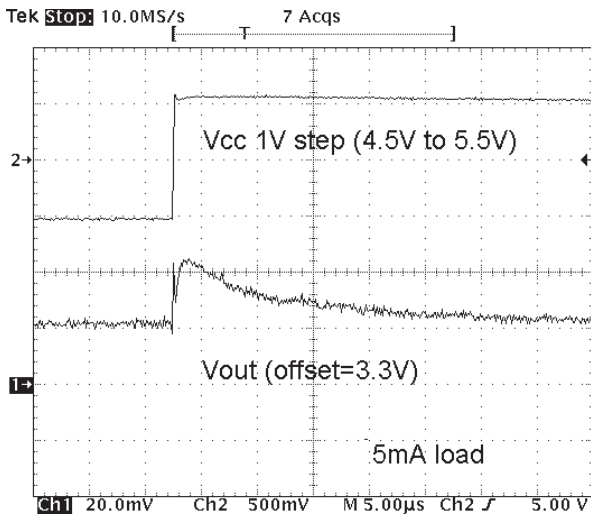
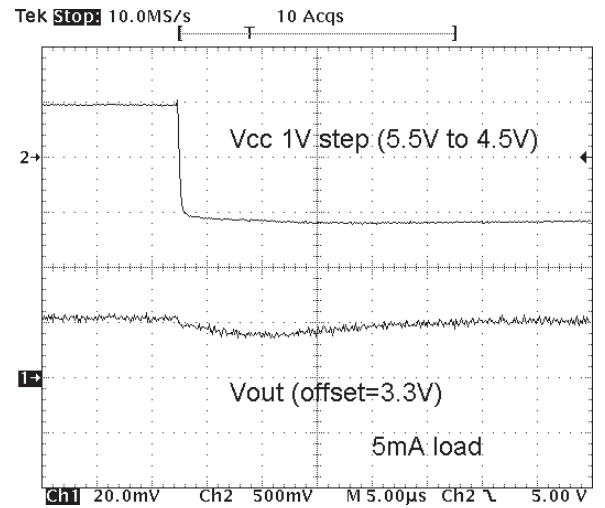

Fig 2.16 V<sub>CC</sub> Load Step Response Falling





Typical Thermal Characteristics

Thermal dissipation of junction heat consists primarily of two paths in series. The first path is the junction to the case ( $\theta_{JC}$ ) thermal resistance which is defined by the package style, and the second path is the case to ambient ( $\theta_{CA}$ ) thermal resistance, which is dependent on board layout. The overall junction to ambient ( $\theta_{JA}$ ) thermal resistance is equal to:

$$\theta_{JA} = \theta_{JC} + \theta_{CA}$$

For a given package style and board layout, the operating junction temperature is a function of junction power dissipation  $P_{JUNC}$  and the ambient temperature, resulting in the following thermal equation:

$$\begin{aligned} T_{JUNC} &= T_{AMB} + P_{JUNC} (\theta_{JC}) + P_{JUNC} (\theta_{CA}) \\ &= T_{AMB} + P_{JUNC} (\theta_{JA}) \end{aligned}$$

The CMPWR300SA is housed in a thermally enhanced package where the GND pins (5 through 8) are integral to the leadframe (fused leadframe). When the device is mounted on a double sided printed circuit board with two square inches of copper allocated for "heat spreading", the resulting  $\theta_{JA}$  is 50°C/W.

Based on a maximum power dissipation of 1.0W (2Vx500mA) with an ambient of 70°C the resulting junction temperature will be:

$$\begin{aligned} T_{JUNC} &= T_{AMB} + P_{JUNC} (\theta_{JA}) \\ &= 70^{\circ}\text{C} + 1.0\text{W} (50^{\circ}\text{C/W}) \\ &= 70^{\circ}\text{C} + 50^{\circ}\text{C} = 120^{\circ}\text{C} \end{aligned}$$

All thermal characteristics of the CMPWR300SA were measured using a double sided board with two square inches of copper area connected to the GND pins for "heat spreading".

Measurements showing performance up to junction temperature of 125°C were performed under light load conditions (5mA). This allows the ambient temperature to be representative of the internal junction temperature.

Note: The use of multi-layer board construction with power planes will further enhance the thermal performance of the package. In the event of no copper area being dedicated for heat spreading, a multi-layer board construction will typically provide the CMPWR300SA with an overall  $\theta_{JA}$  of 70°C/W which allows up to 780mW to be safely dissipated.

**Fig 3.1. Output Voltage vs. Temperature.**

This shows the regulator  $V_{OUT}$  performance up to the maximum rated junction temperature. The overall 125°C variation in junction temperature causes an output voltage change of about 30mV.

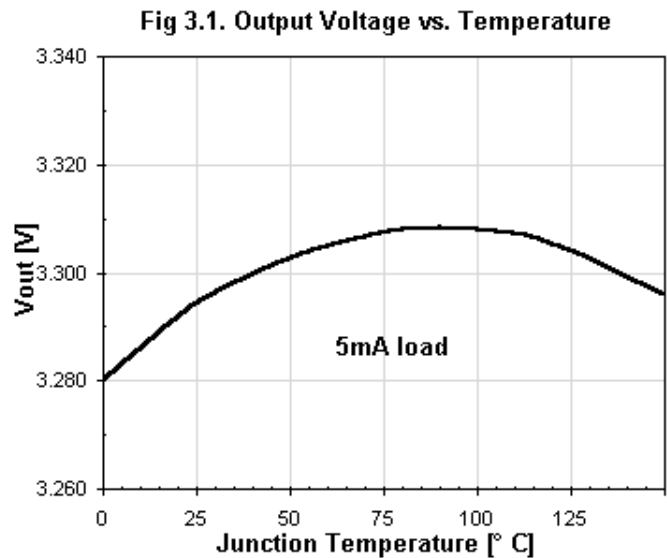



## Typical Thermal Characteristics cont'd

**Fig 3.2. Output Voltage (Rated) vs. Temperature.** This shows the regulator steady state performance when fully loaded (500mA) in an ambient temperature up to the rated maximum of 70°C. The output variation at maximum load is below 10mV across the normal temperature operating.

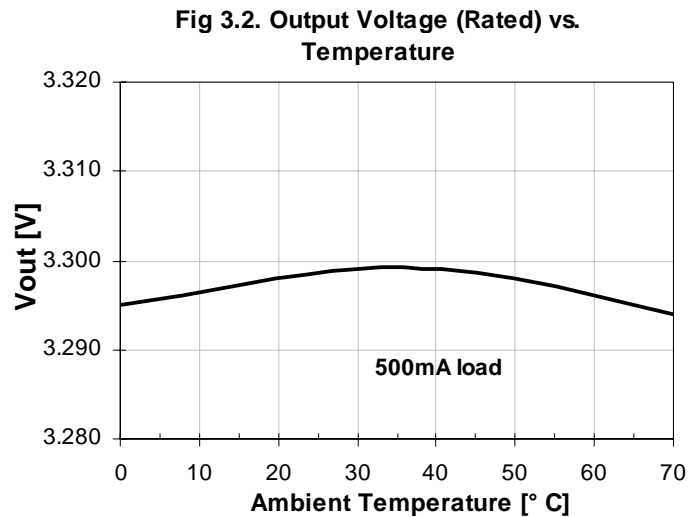

**Fig 3.3. Thresholds vs. Temperature.**

This shows the regulator select/deselect threshold variation up to the maximum rated junction temperature. The overall 125°C change in junction temperature causes a 30mV variation in the select threshold voltage (regulator enable). The deselect threshold level varies about 30mV over the 125°C change in junction temperature. This results in the built-in hysteresis have a minimal variation of 40mV over the entire operating junction temperature range. The hysteresis increases with temperature up to 240mV at 125°C.

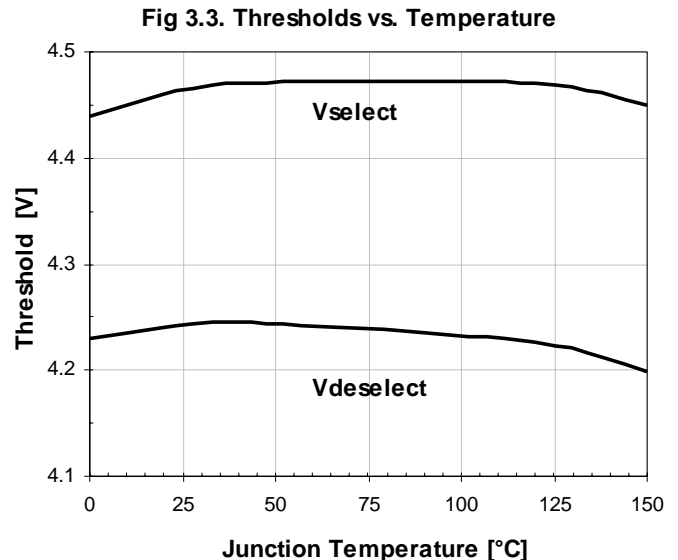

**Fig 3.4.  $V_{AUX}$  Switch Resistance vs. Temperature.**

This shows the  $V_{AUX}$  switch ON resistance variation up to the maximum rated junction temperature. The overall 125°C change in junction temperature causes a 80mΩ variation in the switch resistance. The switch resistance remains below 0.2Ω, even at a junction temperature of 125°C.

