

## Product Description

Sirenza Microdevices' SZA-2044 is a high efficiency class AB Heterojunction Bipolar Transistor (HBT) amplifier housed in a low-cost surface-mountable plastic package. This HBT amplifier is made with InGaP on GaAs device technology and fabricated with MOCVD for an ideal combination of low cost and high reliability.

This product is specifically designed as a final stage for 802.11b/g and 801.16 equipment in the 2.0-2.7 GHz bands. It can run from a 3V to 5V supply. Optimized on-chip impedance matching circuitry provides a 50Ω nominal RF input impedance. The external output match and bias adjustability allows load line optimization for other applications or over narrower bands. It features an output power detector, on/off power control and high RF overdrive robustness.

### Functional Block Diagram

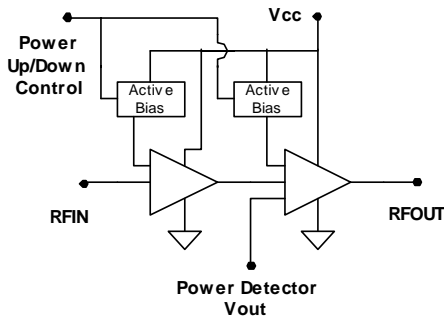

## Key Specifications

Symbol	Parameters: Test Conditions, App circuit page 4 $Z_0 = 50\Omega$ , $V_{CC} = 5.0V$ , $I_q = 300mA$ , $T_{BP} = 30^\circ C$	Unit	Min.	Typ.	Max.
$f_0$	Frequency of Operation	MHz	2000		2700
$P_{1dB}$	Output Power at 1dB Compression – 2.4 GHz	dBm		29.5	
	Output Power at 1dB Compression – 2.5 GHz		28.0	29.5	
$S_{21}$	Small Signal Gain at 2.4 GHz	dB	23.5	25.5	27.5
	Small Signal Gain at 2.5 GHz		23.5	25.5	27.5
$P_{out}$	Output power at 3% EVM 802.11g 54Mb/s - 2.4GHz	dBm		22.5	
	Output Power at 3% EVM 802.11g 54Mb/s - 2.5GHz			22.5	
NF	Noise Figure at 2.5 GHz	dB		6.1	
IM3	Third Order Intermod at 18dBm per tone - 2.5GHz	dBc		-44	-40
IRL	Worst Case Input Return Loss 2.4-2.5GHz	dB	10	13	
ORL	Worst Case Output Return Loss 2.4-2.5GHz		9	11	
Vdet Range	Output Voltage Range for $P_{out}=15dBm$ to $29dBm$	V		0.9 to 1.7	
$I_{cq}$	Quiescent Current ( $V_{CC} = 5V$ )	mA	255	300	345
$I_{VPC}$	Power Up Control Current, $V_{pc}=5V$ , ( $I_{VPC1} + I_{VPC2}$ )	mA		1.9	
$R_{th, j-l}$	Thermal Resistance (junction - lead)	$^\circ C/W$		28	

The information provided herein is believed to be reliable at press time. Sirenza Microdevices assumes no responsibility for inaccuracies or omissions.

Sirenza Microdevices assumes no responsibility for the use of this information, and all such information shall be entirely at the user's own risk. Prices and specifications are subject to change without notice. No patent rights or licenses to any of the circuits described herein are implied or granted to any third party. Sirenza Microdevices does not authorize or warrant any Sirenza Microdevices product for use in life-support devices and/or systems.

Copyright 2002 Sirenza Microdevices, Inc. All worldwide rights reserved.  
303 South Technology Court Broomfield, CO 80021

Phone: (800) SMI-MMIC

## SZA-2044

### 2.0-2.7 GHz 5V 1W Power Amplifier



4mm x 4mm QFN Package

### Product Features

- **802.11g 54Mb/s Class AB Performance**  
 $P_{out} = 22.5dBm$  @ 3% EVM, 5V, 340mA  
 $P_{out} = 18dBm$  @ 3% EVM, 3.3V, 175mA
- **On-chip Output Power Detector**
- $P_{1dB} = 29.5dBm$  @ 5V,  $P_{1dB} = 25dBm$  @ 3.3V
- **Robust - Survives RF Input Power = +15dBm**  
 - 1000V ESD Class 1C
- **Power up/down control < 1μs**

### Applications

- 802.11b/g WLAN
- 2.4GHz ISM General Purpose Applications
- WiMax 802.16, MMDS and MDS bands

### Pin Out Description

Pin #	Function	Description
1,2,4,5,7,9,11,13,15,17,19	N/C	These are unused pins and not wired inside the package. They may be grounded or connected to adjacent pins.
6	VPC1	VPC1 is the bias control pin for the stage 1 active bias circuit. An external series resistor is required for proper setting of bias levels. Refer to the evaluation board schematic for resistor value. To prevent potential damage, do not apply voltage to this pin that is +1V greater than voltage applied to pin 20 (Vbias) unless Vpc supply current capability is less than 10 mA.
8	VPC2	VPC2 is the bias control pin for the stage 2 active bias circuit. An external series resistor is required for proper setting of bias levels. Refer to the evaluation board schematic for resistor value. To prevent potential damage, do not apply voltage to this pin that is +1V greater than voltage applied to pin 20 (Vbias) unless Vpc supply current capability is less than 10 mA.
10	Vdet	Output power detector voltage. Load with > 10K ohms for best performance
3	RFIN	RF input pin. This is DC grounded internal to the IC. Do not apply voltage to this pin.
12,14	RFOUT	RF output pin. This is also another connection to the 2nd stage collector.
16	VC2	2nd stage collector bias pin. Apply 3.0 to 5.0V to this pin.
18	VC1	1st stage collector bias pin. Apply 3.0 to 5.0V to this pin.
20	Vbias	Active bias network VCC. Apply 3.0 to 5.0V to this pin.
EPAD	Gnd	Exposed area on the bottom side of the package needs to be soldered to the ground plane of the board for optimum thermal and RF performance. Several vias should be located under the EPAD as shown in the recommended land pattern (page 5).

### Simplified Device Schematic

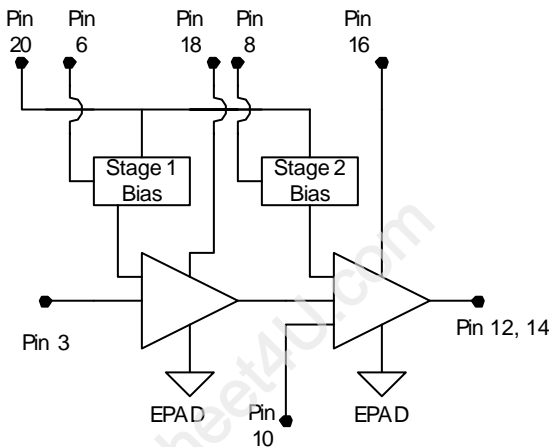

### Absolute Maximum Ratings

Parameters	Value	Unit
VC2 Collector Bias Current ( $I_{VC2}$ )	500	mA
VC1 Collector Bias Current ( $I_{VC1}$ )	150	mA
Device Voltage ( $V_D$ )	7.0	V
Power Dissipation	3	W
Operating Lead Temperature ( $T_L$ )	-40 to +85	°C
Max RF Input Power for 50 ohm output load	15	dBm
Max RF Input Power for 10:1 VSWR RF out load	8	dBm
Storage Temperature Range	-40 to +150	°C
Operating Junction Temperature ( $T_J$ )	+150	°C
ESD Human Body Model (Class 1C)	>1000	V

Operation of this device beyond any one of these limits may cause permanent damage. For reliable continuous operation the device voltage and current must not exceed the maximum operating values specified in the table on page one.

Bias conditions should also satisfy the following expression:  

$$I_D V_D < (T_J - T_L) / R_{TH} \text{ } ^\circ\text{C}$$



#### Caution: ESD Sensitive

Appropriate precaution in handling, packaging and testing devices must be observed.

Performance: 2.3 - 2.7 GHz Evaluation Board Data ( $V_{CC} = V_{PC} = 5.0V$ ,  $I_q = 300mA$ )

S11 - Input Return Loss

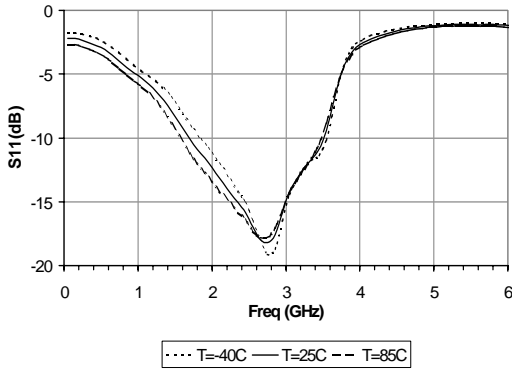

S12 - Isolation

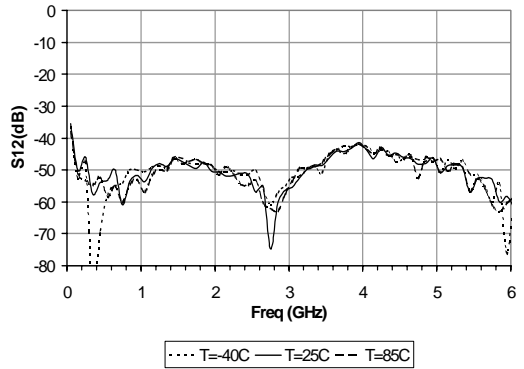

S21 - Gain

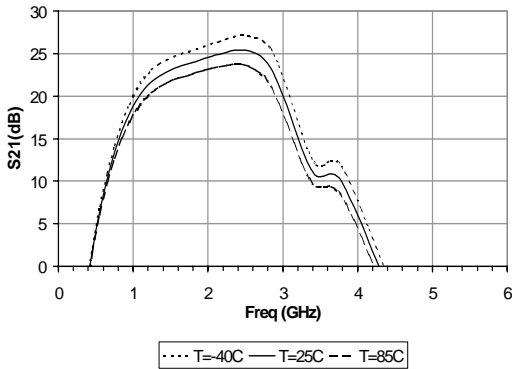

S22 - Output Return Loss

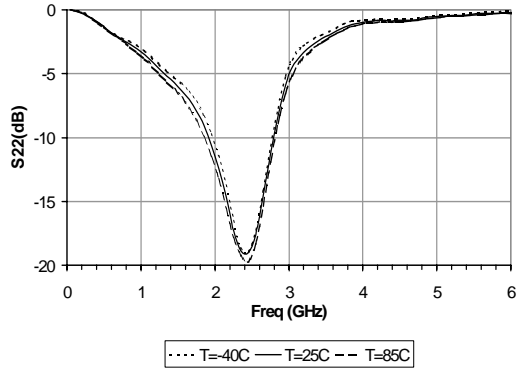

Narrowband S11 - Input Return Loss

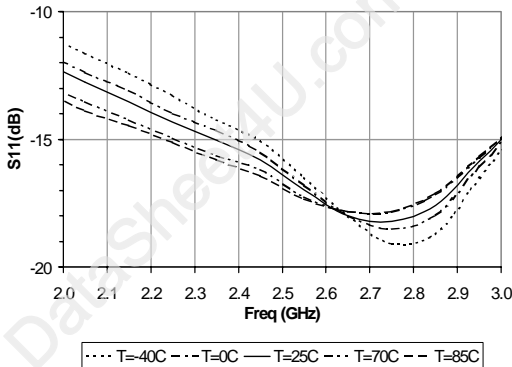

Narrowband S12 - Isolation

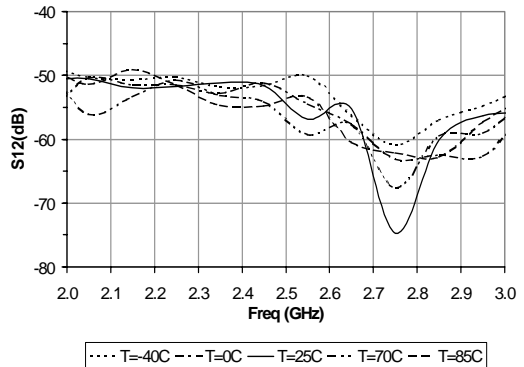

Performance: 2.3 - 2.7 GHz Evaluation Board Data ( $V_{cc} = V_{pc} = 5.0V$ ,  $I_q = 300mA$ )

Narrowband S21 - Gain

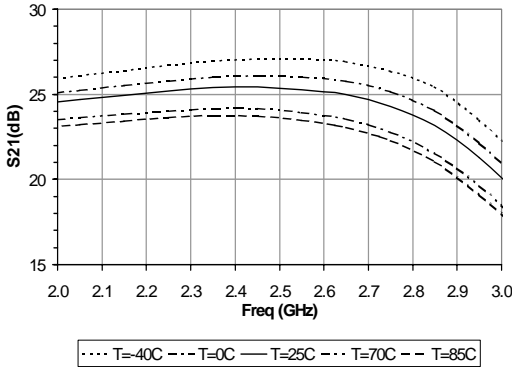

Narrowband S22 - Output Return Loss

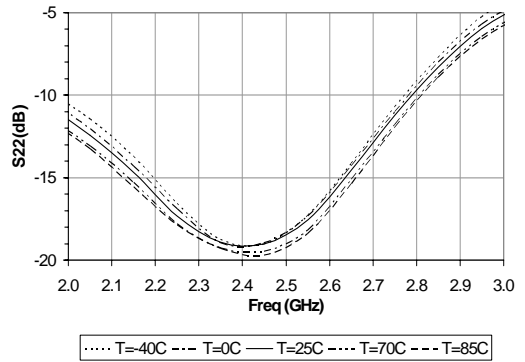

EVM vs Pout, F=2.4GHz  
802.11g, OFDM, 54 Mb/s, 64QAM

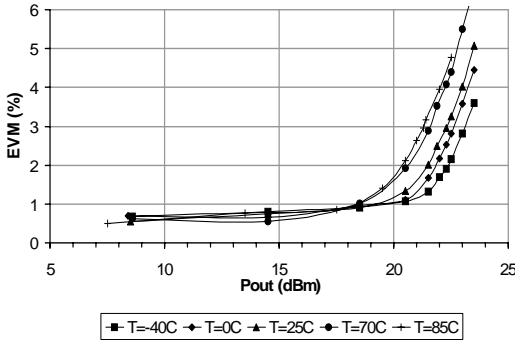

EVM vs Pout, F=2.5GHz  
802.11g, OFDM, 54 Mb/s, 64QAM

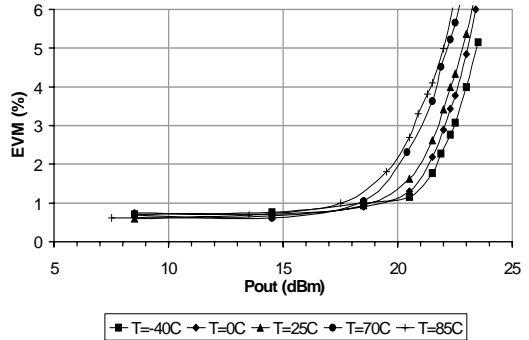

DC Supply Current (I<sub>dc</sub>) vs Pout, T=25C

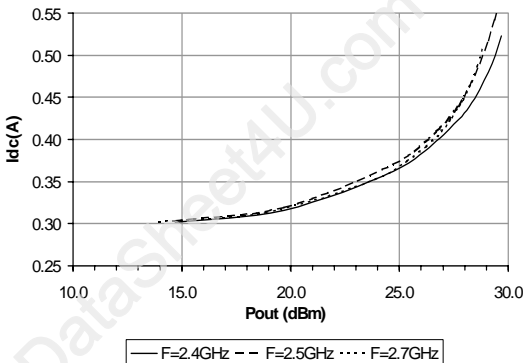

I<sub>cq</sub> (DC Bias Point) vs V<sub>supply</sub> (V<sub>+</sub> and V<sub>pc</sub>)

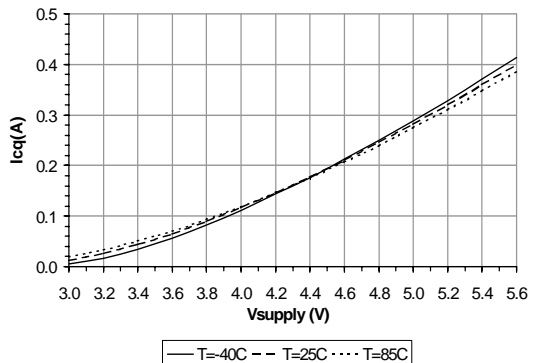

Performance: 2.3 - 2.7 GHz Evaluation Board Data ( $V_{cc} = V_{pc} = 5.0V, I_q = 300mA$ )

RF Power Detector (Vdet) vs Pout  
F=2.4GHz

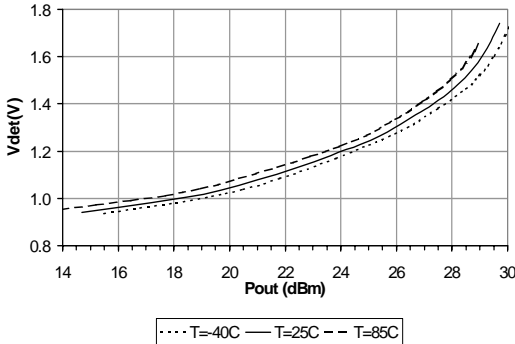

RF Power Detector (Vdet) vs Pout  
F=2.5GHz

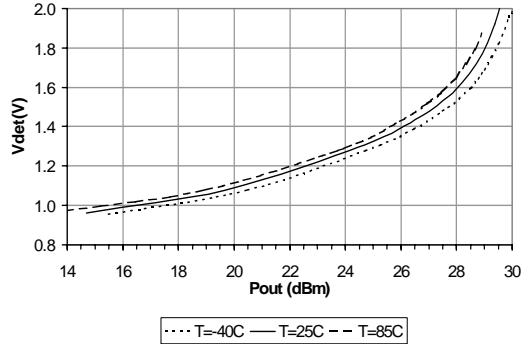

RF Power Detector (Vdet) vs Pout  
F=2.7GHz

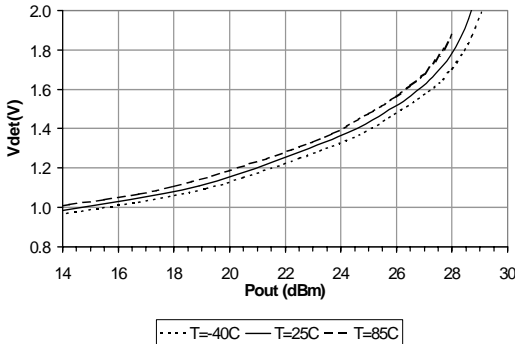

Gain vs Pout, T=25C

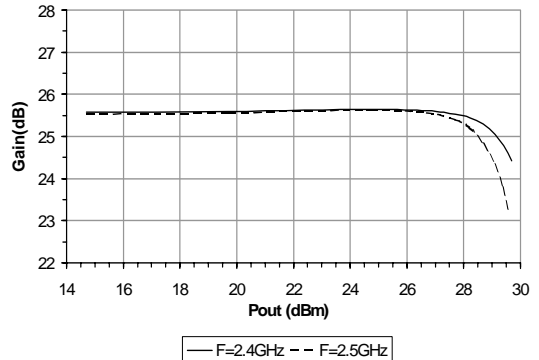

IM3 vs Pout (2 tone avg.), T=25C  
Tone Spacing=1MHz

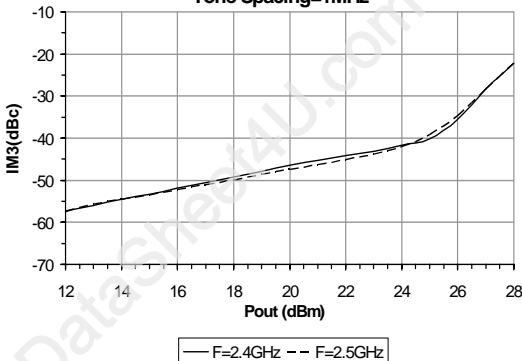

Performance: 2.3 - 2.7 GHz Evaluation Board Data ( $V_{CC} = V_{PC} = 5.0V, I_Q = 300mA$ )

802.11b Spectral Regrowth vs. Output Power at 2.4 GHz

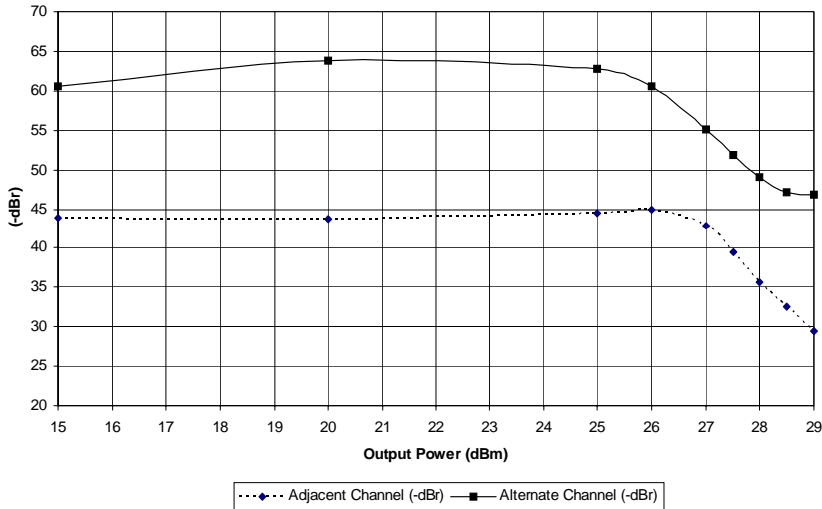

Output Power Spectrum 802.11b 11mbps cck, Pout = 27.8dBm at 2.4GHz

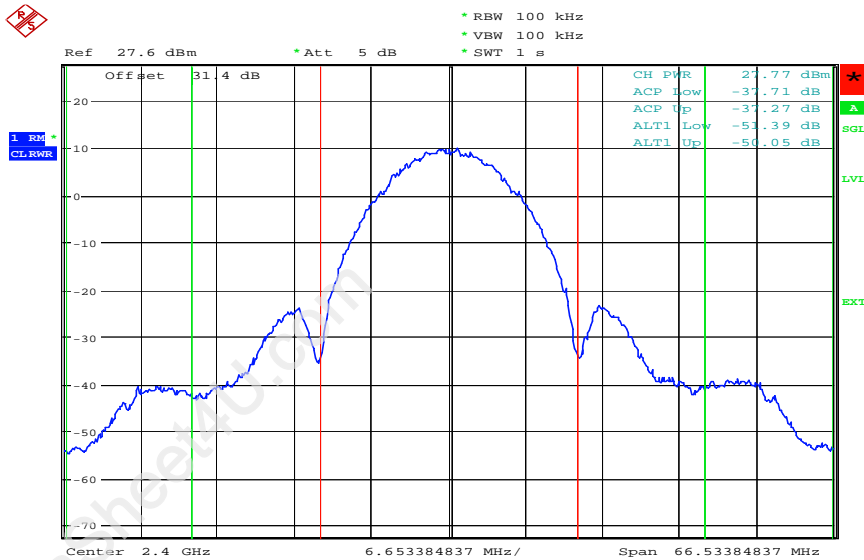

Date: 3.AUG.2004 15:48:28

## 2.0 - 2.7 GHz Evaluation Board Schematic For V+ = Vcc = 5.0V

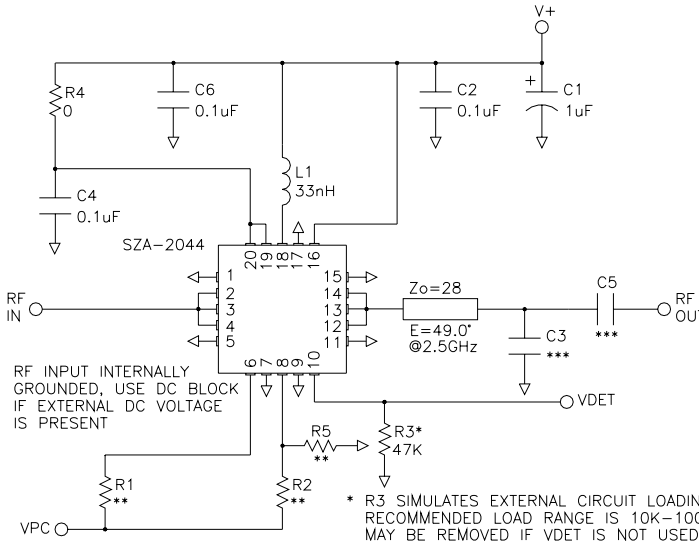

**Important Note:**  
Pins 1,2,4,5,7,9,11,13,15,17,19 are unwired (N/C) inside the package. Refer to page 2 for detailed pin descriptions. Some of these pins are wired to adjacent pins or grounded as shown in the application circuit. This is to maintain consistency with the evaluation board layout shown below. It is recommended to use this layout and wiring to achieve the specified performance.

**Note:**  
Application circuits are available for 2.1-2.4GHz and 2.5-2.7GHz bands. Only the output matching circuit component values change. Contact applications engineering.

\* R3 SIMULATES EXTERNAL CIRCUIT LOADING TO GROUND. RECOMMENDED LOAD RANGE IS 10K-100K OHMS. MAY BE REMOVED IF VDET IS NOT USED

\*\* SEE TABLE BELOW OR APP NOTE AN-068 FOR VALUES

\*\*\* SEE TABLE BELOW FOR MATCHING COMPONENT VALUES

For VCC=3.3V application circuit, contact Applications Engineering.

## 2.0 - 2.7 GHz Evaluation Board Layout For V+ = Vcc = 5.0V

Board material GETEK, 10mil thick, Dk=3.9, 2 oz. copper

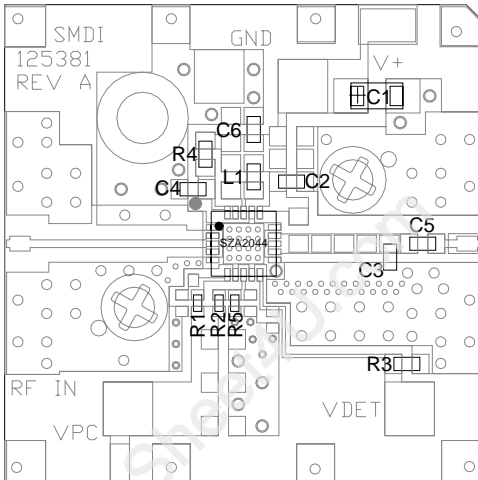

DESG	DESCRIPTION
Q1	SZA-2044
R1	See Table 2, 0402 1%
R2	See Table 2, 0402 1%
R3	47K OHM, 0603 or 0402
R4	0 OHM, 0603 or 0402
R5	See Table 2, 0402 1%
C1	1uF 16V TANTALUM CAP
C2,4,6	0.1uF CAP, 0603 or 0402
C3	See Table 1, 0603
C5	See Table 1, 0603
L1	33nH IND, 0603 (TOKO LL1608-FH33NJ OR EQUIV)

Freq. Range	C3	C5
2.0 - 2.2 GHz	1.0pF	15pF
2.3 - 2.7 GHz	0.5pF	15pF

Table 1: Output matching capacitor values (Vcc=5V, Iq=302mA)

VPC(V)	R1	R2	R5
2.9	34.8	27.4	OUT
3.0	121	105	OUT
3.1	205	182	OUT
3.2	287	261	OUT
3.3	374	332	OUT
5.0	1.82K	1.10K	4.75K

Table 2: Resistor values for Vpc=2.9V to 5V (Vcc=5V, Iq=302mA)

## Part Number Ordering Information

Part Number	Reel Size	Devices/Reel
SAZ-2044	13"	3000

### Part Symbolization

The part will be symbolized with an "SAZ-2044" marking designator on the top surface of the package.

### Package Outline Drawing (dimensions in mm):

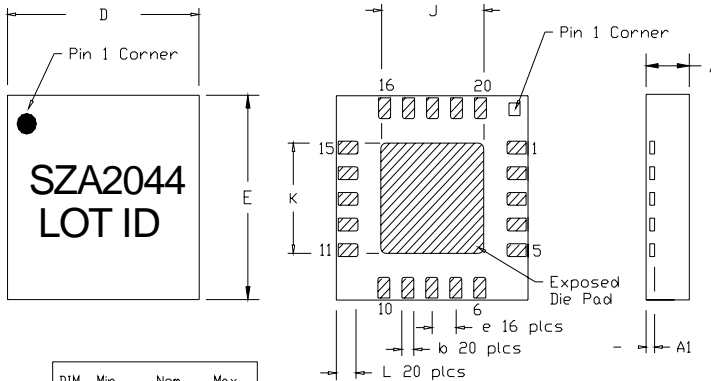

DIM	Min	Nom	Max
A	.80		1.00
A1	.19		.21
b	.20	.25	.30
D		4.0 BSC	
e		0.5 BSC	
E		4.0 BSC	
J	2.04		2.24
K	2.04		2.24
L	.34	.44	.54

### Recommended Land Pattern (dimensions in mm[in]):

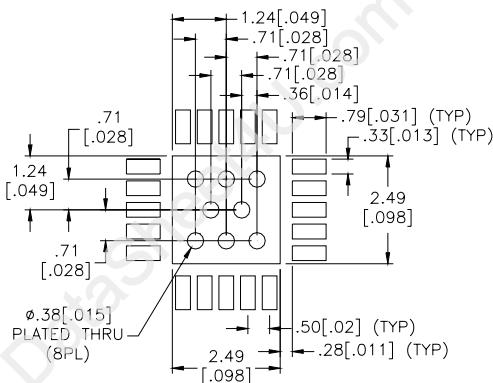

### Recommended PCB Soldermask (SMBOC) for Land Pattern (dimensions in mm[in]):

