

### STANDARD RECOVERY DIODES

Stud Version

#### Features

- High surge current capability
- Avalanche types available
- Stud cathode and stud anode version
- Wide current range
- Types up to 1200V  $V_{RRM}$

6 A

#### Typical Applications

- Battery charges
- Converters
- Power supplies
- Machine tool controls

#### Major Ratings and Characteristics

Parameters	6F(R)	Units
$I_{F(AV)}$	6	A
@ $T_C$	160	°C
$I_{F(RMS)}$	9.5	A
$I_{FSM}$ @ 50Hz	159	A
@ 60Hz	167	A
$I^2t$ @ 50Hz	134	A <sup>2</sup> s
@ 60Hz	141	A <sup>2</sup> s
$V_{RRM}$ range	100 to 1200	V
$T_J$ range	- 65 to 175	°C



## 6F(R) Series

Bulletin I20206 rev. A 09/98

International  
**IR** Rectifier

### ELECTRICAL SPECIFICATIONS

#### Voltage Ratings

Type number	Voltage Code	$V_{RRM}$ , maximum repetitive peak reverse voltage V	$V_{RSM}$ , maximum non-repetitive peak reverse voltage V	$V_{R(BR)}$ , minimum avalanche voltage V (1)	$I_{RRM}$ max. @ $T_J = 175^\circ\text{C}$ mA
6F(R)	10	100	150	--	12
	20	200	275	--	
	40	400	500	500	
	60	600	725	750	
	80	800	950	950	
	100	1000	1200	1150	
	120	1200	1400	1350	

(1) Avalanche version only available from  $V_{RRM}$  400V to 1200V.

#### Forward Conduction

Parameter	6F(R)	Units	Conditions
$I_{F(AV)}$ Max. average forward current @ Case temperature	6	A	180° conduction, half sine wave
	160	°C	
$I_{F(RMS)}$ Max. RMS forward current	9.5	A	
$P_R$ Maximum non-repetitive peak reverse power	4	K/W	10µs square pulse, $T_J = T_J$ max. <b>see note (2)</b>
$I_{FSM}$ Max. peak, one-cycle forward, non-repetitive surge current	159	A	t = 10ms No voltage reappplied
	167		t = 8.3ms
	134		t = 10ms 100% $V_{RRM}$ reappplied
	141		t = 8.3ms
$I^2t$ Maximum $I^2t$ for fusing	127	A <sup>2</sup> s	t = 10ms No voltage reappplied
	116		t = 8.3ms
	90		t = 10ms 100% $V_{RRM}$ reappplied
	82		t = 8.3ms
$I^2\sqrt{t}$ Maximum $I^2\sqrt{t}$ for fusing	1270	A <sup>2</sup> √s	t = 0.1 to 10ms, no voltage reappplied
$V_{F(TO)1}$ Low level value of threshold voltage	0.63	V	$(16.7\% \times \pi \times I_{F(AV)} < I < \pi \times I_{F(AV)})$ , $T_J = T_J$ max.
$V_{F(TO)2}$ High level value of threshold voltage	0.86		$(I > \pi \times I_{F(AV)})$ , $T_J = T_J$ max.
$r_{f1}$ Low level value of forward slope resistance	15.7	mΩ	$(16.7\% \times \pi \times I_{F(AV)} < I < \pi \times I_{F(AV)})$ , $T_J = T_J$ max.
$r_{f2}$ High level value of forward slope resistance	5.6		$(I > \pi \times I_{F(AV)})$ , $T_J = T_J$ max.
$V_{FM}$ Max. forward voltage drop	1.10	V	$I_{pk} = 19A$ , $T_J = 25^\circ\text{C}$ , $t_p = 400\mu\text{s}$ rectangular wave

(2) Available only for Avalanche version, all other parameters the same as 6F.

**Thermal and Mechanical Specifications**

Parameter	6F(R)	Units	Conditions
T <sub>J</sub> Max. junction operating temperature range	-65 to 175	°C	
T <sub>stg</sub> Max. storage temperature range	-65 to 200		
R <sub>thJC</sub> Max. thermal resistance, junction to case	2.5	K/W	DC operation
R <sub>thCS</sub> Max. thermal resistance, case to heatsink	0.5		Mounting surface, smooth, flat and greased
T Mounting torque, ± 10%	1.2 (1.5)	Nm	Lubricated threads (Not lubricated threads)
wt Approximate weight	7 (0.25)	g (oz)	
Case style	DO-203AA (DO-4)		See Outline Table

**ΔR<sub>thJC</sub> Conduction**

(The following table shows the increment of thermal resistance R<sub>thJC</sub> when devices operate at different conduction angles than DC)

Conduction angle	Sinusoidal conduction	Rectangular conduction	Units	Conditions
180°	0.34	0.29	K/W	T <sub>J</sub> = T <sub>J</sub> max.
120°	0.44	0.48		
90°	0.57	0.63		
60°	0.85	0.88		
30°	1.37	1.39		

**Ordering Information Table**

**Device Code**

A	6	F	R	120	M
①	②	③	④	⑤	⑥

- 1** - A = Avalanche diode  
None = Standard diode
- 2** - Current rating: Code = I<sub>F(AV)</sub>
- 3** - F = Standard device
- 4** - None = Stud Normal Polarity (Cathode to Stud)  
R = Stud Reverse Polarity (Anode to Stud)
- 5** - Voltage code: Code x 10 = V<sub>RRM</sub> (See Voltage Ratings table)
- 6** - None = Stud base DO-203AA (DO-4) 10-32UNF-2A  
M = Stud base DO-203AA (DO-4) M5 X 0.8 - (Not available for Avalanche diodes)

# 6F(R) Series

Bulletin I20206 rev. A 09/98

## Outlines Table

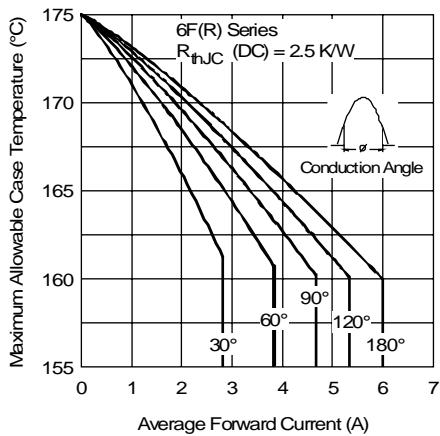
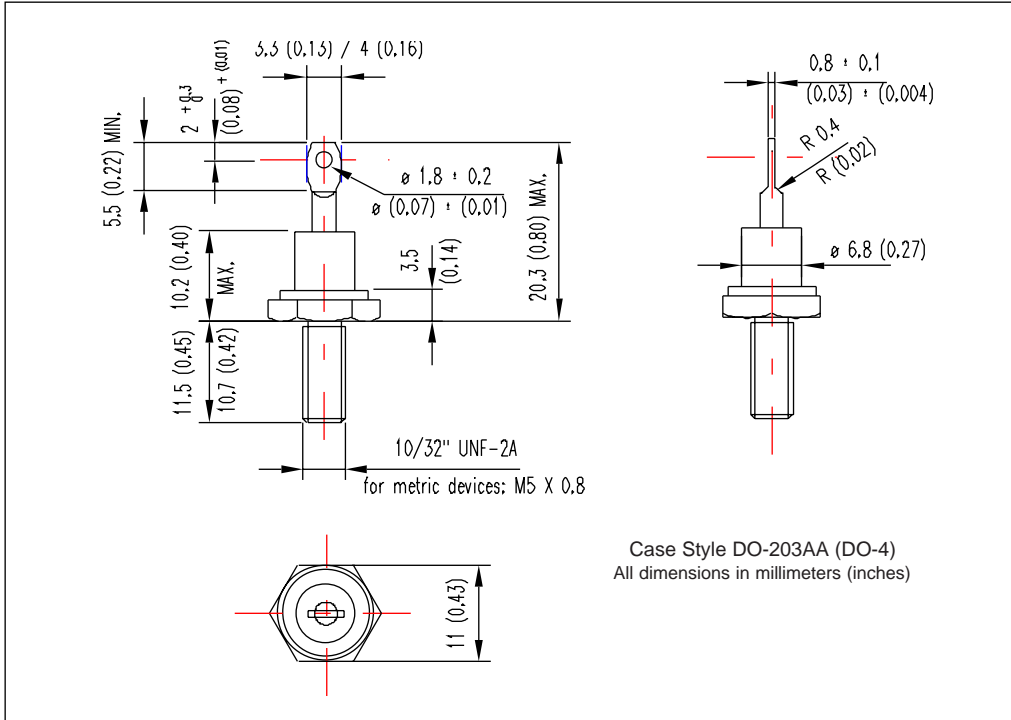

Fig. 1 - Current Ratings Characteristics

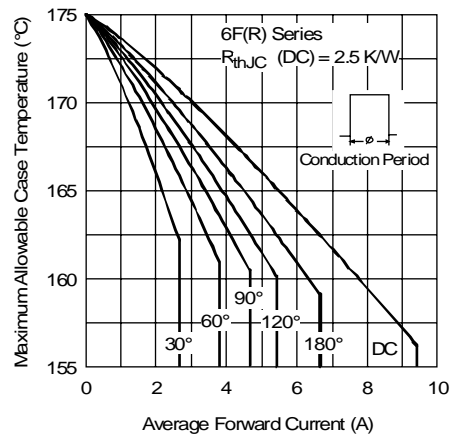

Fig. 2 - Current Ratings Characteristics

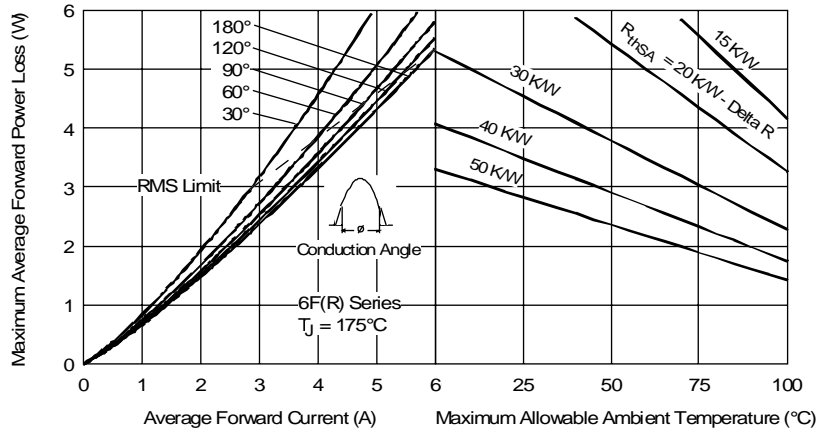

Fig. 3 - Forward Power Loss Characteristics

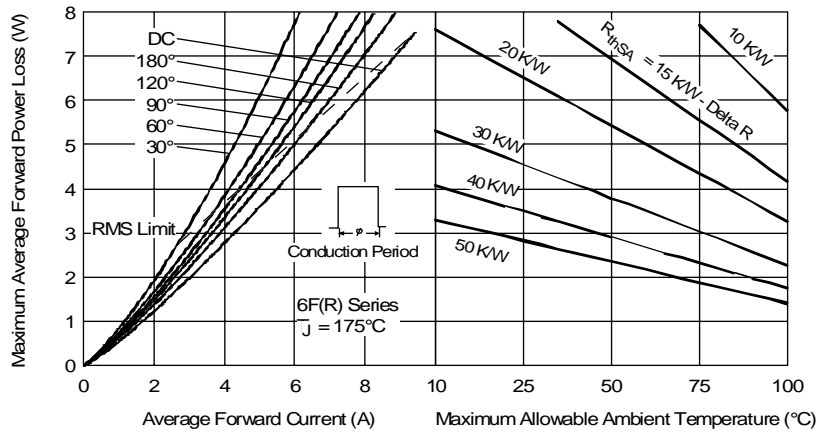

Fig. 4 - Forward Power Loss Characteristics

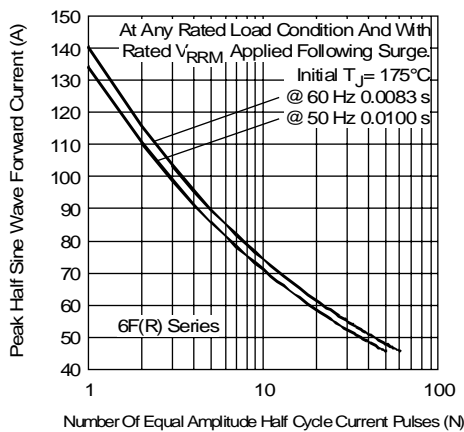

Fig. 5 - Maximum Non-Repetitive Surge Current

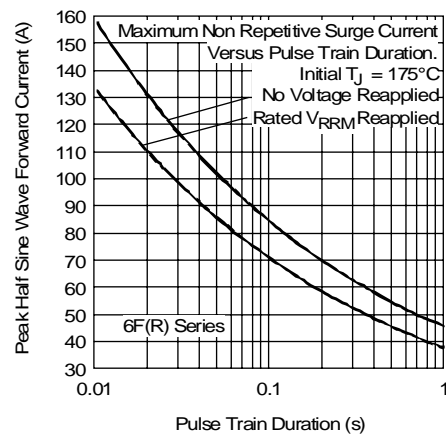

Fig. 6 - Maximum Non-Repetitive Surge Current

## 6F(R) Series

Bulletin I20206 rev. A 09/98

International  
**IR** Rectifier

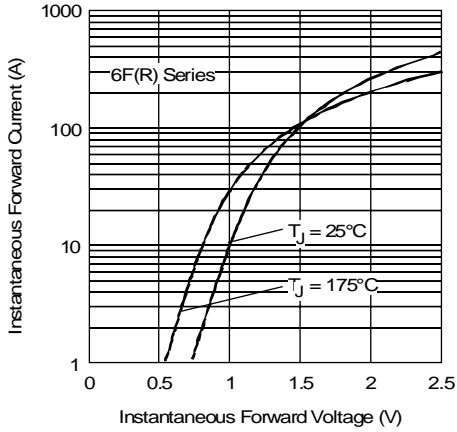

Fig. 7 - Forward Voltage Drop Characteristics

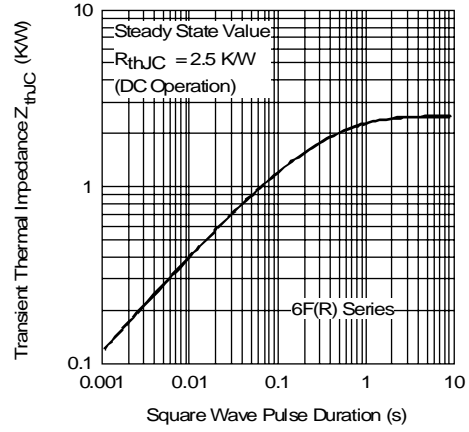

Fig. 8 - Thermal Impedance  $Z_{thJC}$  Characteristics

International  
**IR** Rectifier

**WORLD HEADQUARTERS:** 233 Kansas St., El Segundo, California 90245 U.S.A. Tel: (310) 322 3331. Fax: (310) 322 3332.  
**EUROPEAN HEADQUARTERS:** Hurst Green, Oxted, Surrey RH8 9BB, U.K. Tel: ++ 44 1883 732020. Fax: ++ 44 1883 733408.  
**IR CANADA:** 15 Lincoln Court, Brampton, Markham, Ontario L6T3Z2. Tel: (905) 453 2200. Fax: (905) 475 8801.  
**IR GERMANY:** Saalburgstrasse 157, 61350 Bad Homburg. Tel: ++ 49 6172 96590. Fax: ++ 49 6172 965933.  
**IR ITALY:** Via Liguria 49, 10071 Borgaro, Torino. Tel: ++ 39 11 4510111. Fax: ++ 39 11 4510220.  
**IR FAR EAST:** K&H Bldg., 2F, 30-4 Nishi-Ikebukuro 3-Chome, Toshima-Ku, Tokyo, Japan 171. Tel: 81 3 3983 0086.  
**IR SOUTHEAST ASIA:** 1 Kim Seng Promenade, Great World City West Tower, 13-11, Singapore 237994. Tel: ++ 65 838 4630.  
**IR TAIWAN:** 16 Fl. Suite D.207, Sec. 2, Tun Haw South Road, Taipei, 10673, Taiwan. Tel: 886 2 2377 9936.

<http://www.irf.com>

Fax-On-Demand: +44 1883 733420

Data and specifications subject to change without notice.