

April 1985

Description

The μPD65000 (CMOS-2) series of gate arrays are low-power, high-speed devices featuring 3-micron silicon gate CMOS technology. The basic cell on the chip consists of four transistors, two P-channel and two N-channel, with double-layer metal interconnects. See figures 1 and 2.

Gate arrays are available in a variety of sizes (400 to 2,000 cells) and package types.

Gate arrays are intended for customers seeking cost effective alternatives. With gate arrays, customers can reduce component count and board size so that they can be more competitive in the markets they serve. NEC's gate array program allows a customized IC to be developed quickly and at a small fraction of the cost of a full custom development program.

NEC's comprehensive CAD support system and master slice system significantly reduce the time and expense usually associated with semicustom devices. Normal turnaround time, after logic validation, is only 8 to 12 weeks. Advanced CAD tools, such as logic simulation, automatic placement and routing, delay simulation, and test program generation ensure accurate error-free designs of all NEC gate arrays.

Features

- High speed: 3.0 ns/gate (with fan-out of 3 and 3-mm wiring)
- Low power: 30 μW/gate/MHz
- Quick turnaround time: 8 - 12 weeks
- Simple interface to customer's circuit diagram and test pattern sheets
- Fully supported by advanced CAD
 - Logic simulation
 - Automatic placement and routing
 - Test program generation
 - Delay simulation
- Direct access to CAD simulation
 - Designers can use their own terminals through a local network to an NEC design center for logic simulation
- Four types of output buffers
 - Normal
 - Open-drain
 - Three-state
 - Bidirectional
- Wide choice of DIP, QIP, PGA, and flat packages to suit unique applications

Figure 1. CMOS Gate Array Chip Layout

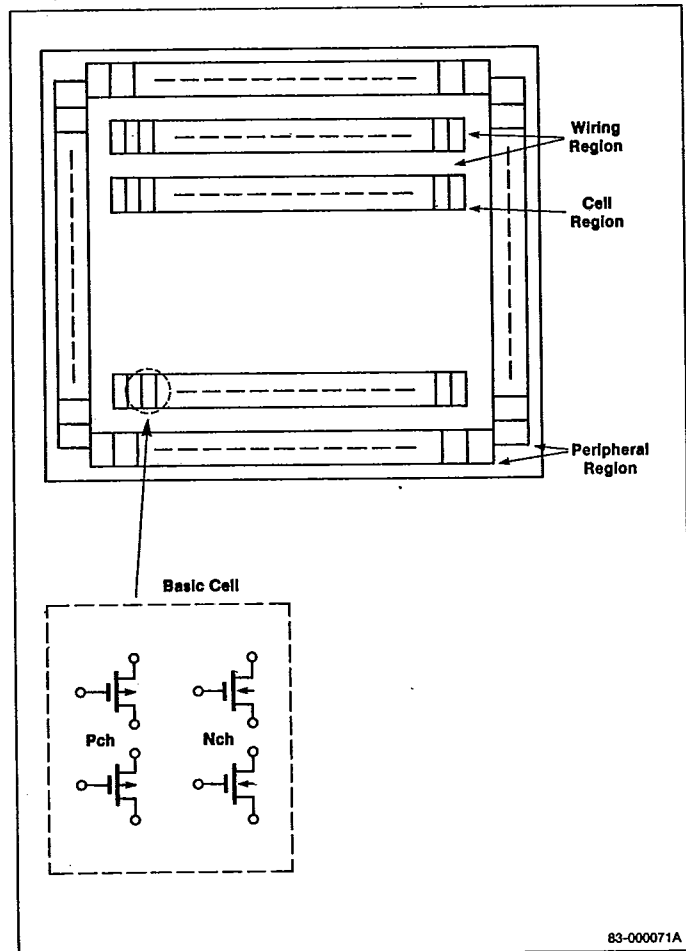
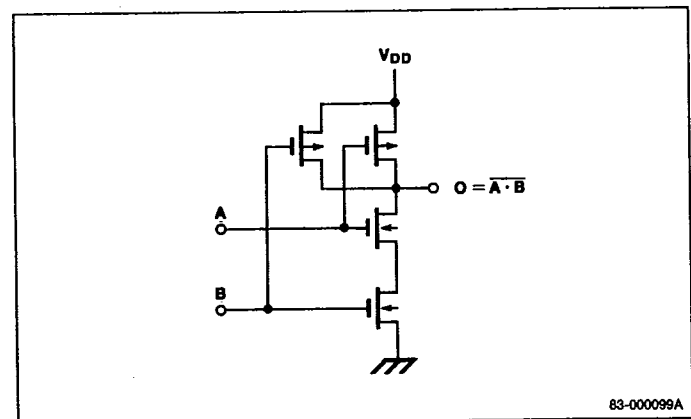

Figure 2. Cell Configured as a Two-Input NAND Gate



**μPD65000 (CMOS-2) SERIES
3-MICRON**



Absolute Maximum Ratings

T_A = +25°C

Power supply voltage, V _{DD}	-0.5 to +7.0 V
Input voltage, V _I	-0.5 V to V _{DD} + 0.5 V
Output current, I _O	10 mA
Operating temperature, T _{OPT}	-40 to +85°C
Storage temperature, T _{STG}	-65 to +150°C

Comment: Exposing the device to stresses above those listed in Absolute Maximum Ratings could cause permanent damage. The device is not meant to be operated outside the Recommended Operating Conditions below. Exposure to absolute maximum rating conditions for extended periods may affect device reliability.

Recommended Operating Conditions

T_A = -40 to +85°C

Parameter	Symbol	Limits			Unit	Test Conditions
		Min	Typ	Max		
Power supply voltage	V _{DD}	4.5	5	5.5	V	
Input voltage	V _I	0		V _{DD}	V	
Low-level input voltage	V _{IL}	0		0.3 V _{DD}	V	CMOS level
High-level input voltage	V _{IH}	0.7 V _{DD}		V _{DD}	V	CMOS level
Low-level input voltage	V _{IL}	0		0.8	V	TTL level ¹
High-level input voltage	V _{IH}	2.0		V _{DD}	V	TTL level ¹
Input rise, fall times	t _R , t _F	0		10	μs	

Note: 1. T_A = 0 to +70°C, V_{DD} = 5 V ±5%

Configuration Data

	μPD65003	μPD65002	μPD65010	μPD65020
Number of cells	427	858	1,368	2,112
Configuration	61 rows x 7 columns	66 rows x 13 columns	76 rows x 18 columns	96 rows x 22 columns
Number of input buffers	38	48	64	78
Number of output buffers	36	48	64	78

DC Characteristics

T_A = -40 to +85°C; V_{DD} = 5 V ±10%

Parameter	Symbol	Limits			Unit	Test Conditions
		Min	Typ	Max		
Static current	I _L		0.1	200	μA	V _I = V _{DD} or GND
Dynamic current	I _{DD}		6		μA	1 MHz
Input current	I _I		10 ⁻⁵	10	μA	V _I = V _{DD} or GND
Low-level output current	I _{OL}	3.2	6		mA	V _{OL} = 0.4 V
High-level output current	I _{OH}	1	2		mA	V _{OH} = V _{DD} - 0.4 V
Low-level output voltage	V _{OL}			0.1	V	I _O = 0
High-level output voltage	V _{OH}	V _{DD} - 0.1			V	I _O = 0

AC Characteristics

T_A = -40 to +85°C; V_{DD} = 5 V ±10%

Parameter	Symbol	Limits			Unit	Test Conditions
		Min	Typ	Max		
Maximum operating frequency	f _{MAX}	10	25		MHz	
Delay time ¹	t _{PD} t _{PD}		3 12		ns	Gate Output buffer ²
Output rise time	t _R		15		ns	C _L = 15 pF
Output fall time	t _F		8		ns	C _L = 15 pF

Note: 1. With fan-out of 3 and 3 mm wiring.
2. With C_L = 15 pF

Figure 3. Example of a Circuit Diagram

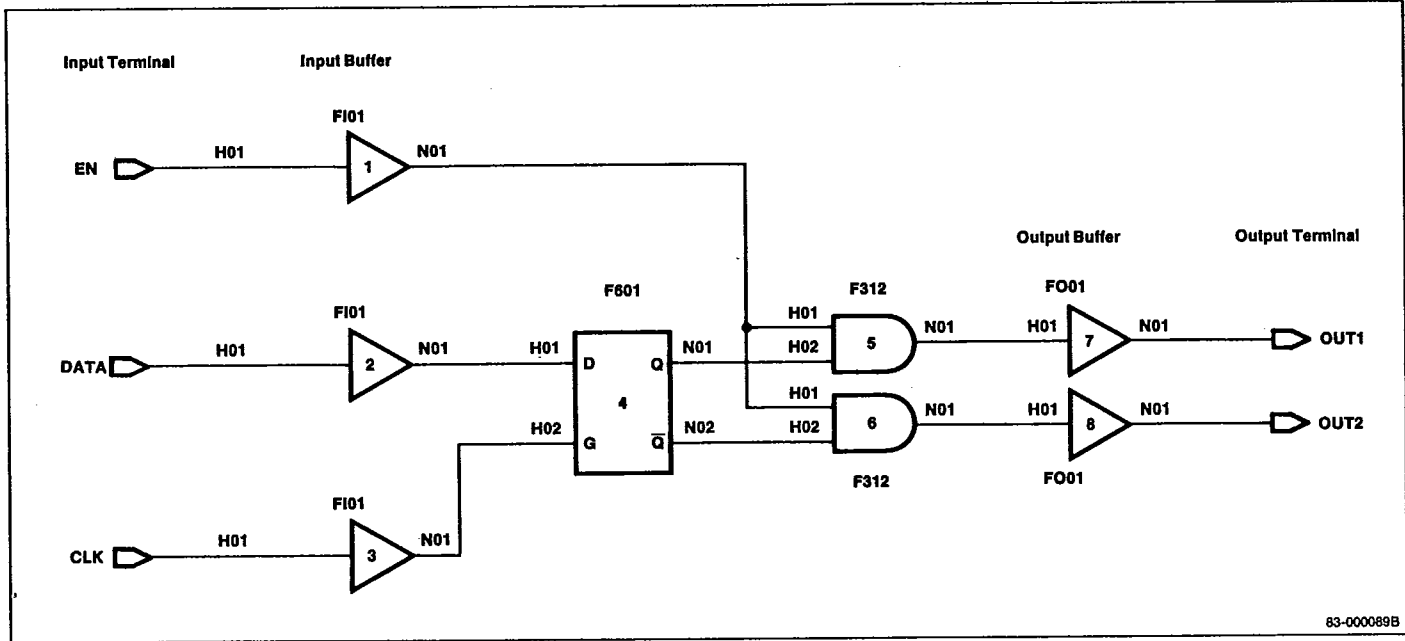

83-000089B

Figure 4. Example of a Test Pattern Chart

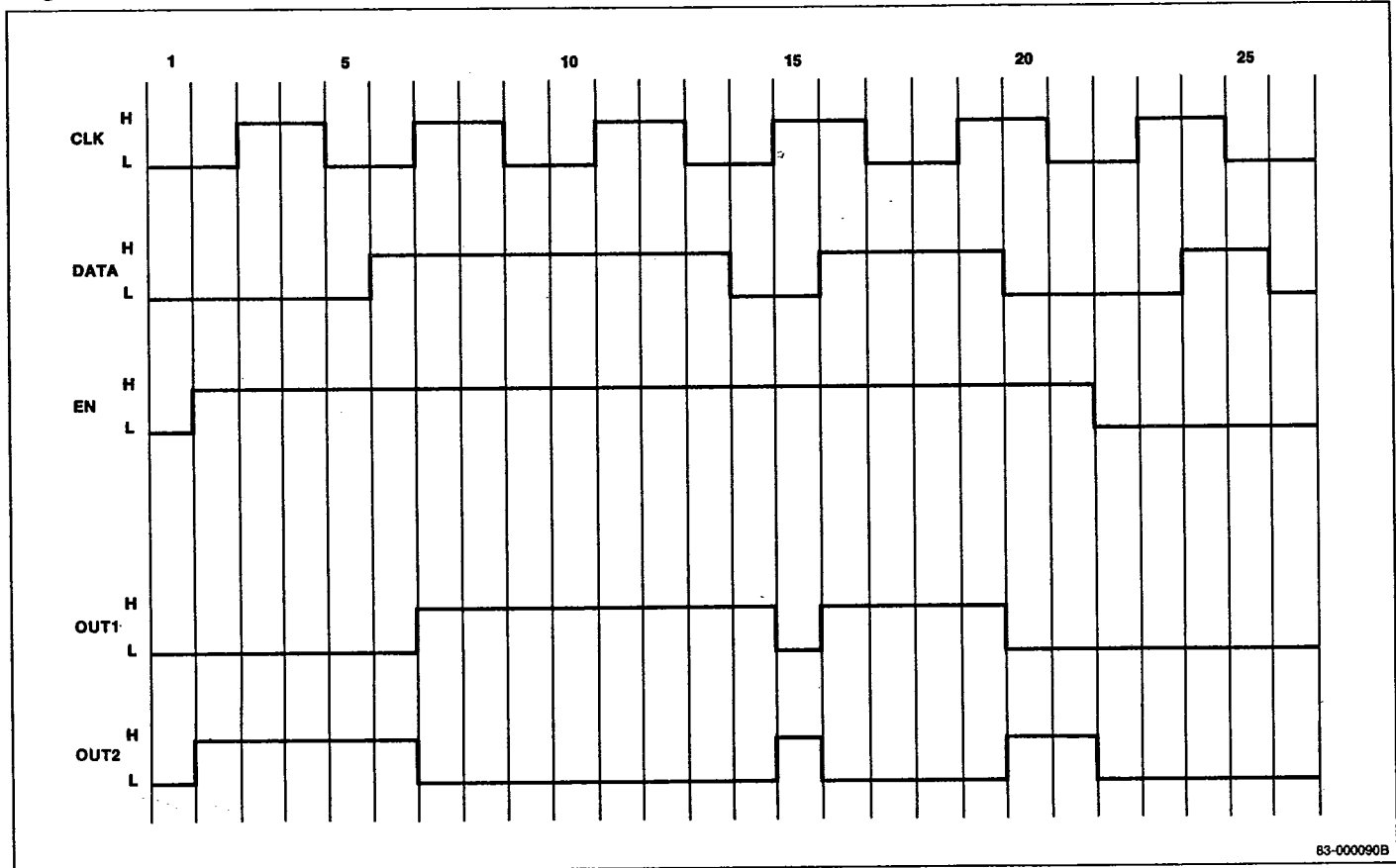

83-000090B

**μPD65000 (CMOS-2) SERIES
3-MICRON****NEC**
www.DataSheet4U.com**Gate Array Development Process**

Figure 5 is a flowchart showing supporting data, development steps, and customer/NEC interface options.

Customer/NEC Interface Options

NEC's computer and communications environment allows gate array designers to select the interface most suitable to their needs.

Standard Data. For the simplest interface, the customer provides a circuit diagram and test patterns. The remainder of the development process is NEC's responsibility.

Macro Converted Data. The customer provides a circuit diagram based on the macros in the Block Library plus test pattern data.

File Generated Data. The customer provides a netlist and test pattern file in NEC compatible format. The netlist is a text file describing circuit interconnections. Data may be sent to NEC on magnetic tape or a floppy disk or transmitted via telephone. The formats and procedures for handling these files will be fully specified by the appropriate NEC Design Center.

Graphic PC Generated Data. Using the PC9800 workstation, a customer can easily generate the necessary netlist and test pattern file. The PC9800 workstation supports schematic capture and limited design rule checking.

Workstation Generated Data. For this interface, the customer performs logic simulation using either workstations by Valid Systems, Mentor Graphics, Daisy Systems and others, or the TEGAS-5™ software on a main frame computer. NEC does the final compatibility check. (Separate manuals describe the various workstation interfaces.)

PG Mask Tape Interface. A separate manual will be issued when this interface becomes available.

TEGAS-5 is the trademark of Calma Company.

Development Steps

Design Rule Checking. Once the circuit interconnect data is complete, the first step of the logic validation process is the design rule check. Parameters such as cell usage, power dissipation and fan-out loading are determined and checked.

Unit Simulation [Static Logic Simulation]. Here, any coding errors and data conversion errors are eliminated.

Delay Time Simulation. Before automatic placement and routing, delay time simulation gives an accurate estimate of the expected circuit delays.

Automatic Placement and Routing. NEC's advanced software allows up to 95-percent cell utilization without resorting to manual routing.

Final Delay Time Simulation. Here, wire lengths are taken into account. Results of this step provide the customer with an accurate circuit analysis.

Production. If the above steps are completed successfully, design enters actual production followed by 100-percent wafer testing.

Packaging. Successfully tested wafers are divided into individual chips, which are then die-bonded onto the customer-specified package. Chips are then wire-bonded and sealed. The dc parameters and logic functions of each chip are checked in the final test.

Prototype Evaluation. Ten engineering samples are delivered to the customer for the system function test. If customer evaluation is satisfactory, the development process is finished. NEC is ready to begin mass production.



Figure 5. Flowchart for Gate Array Development

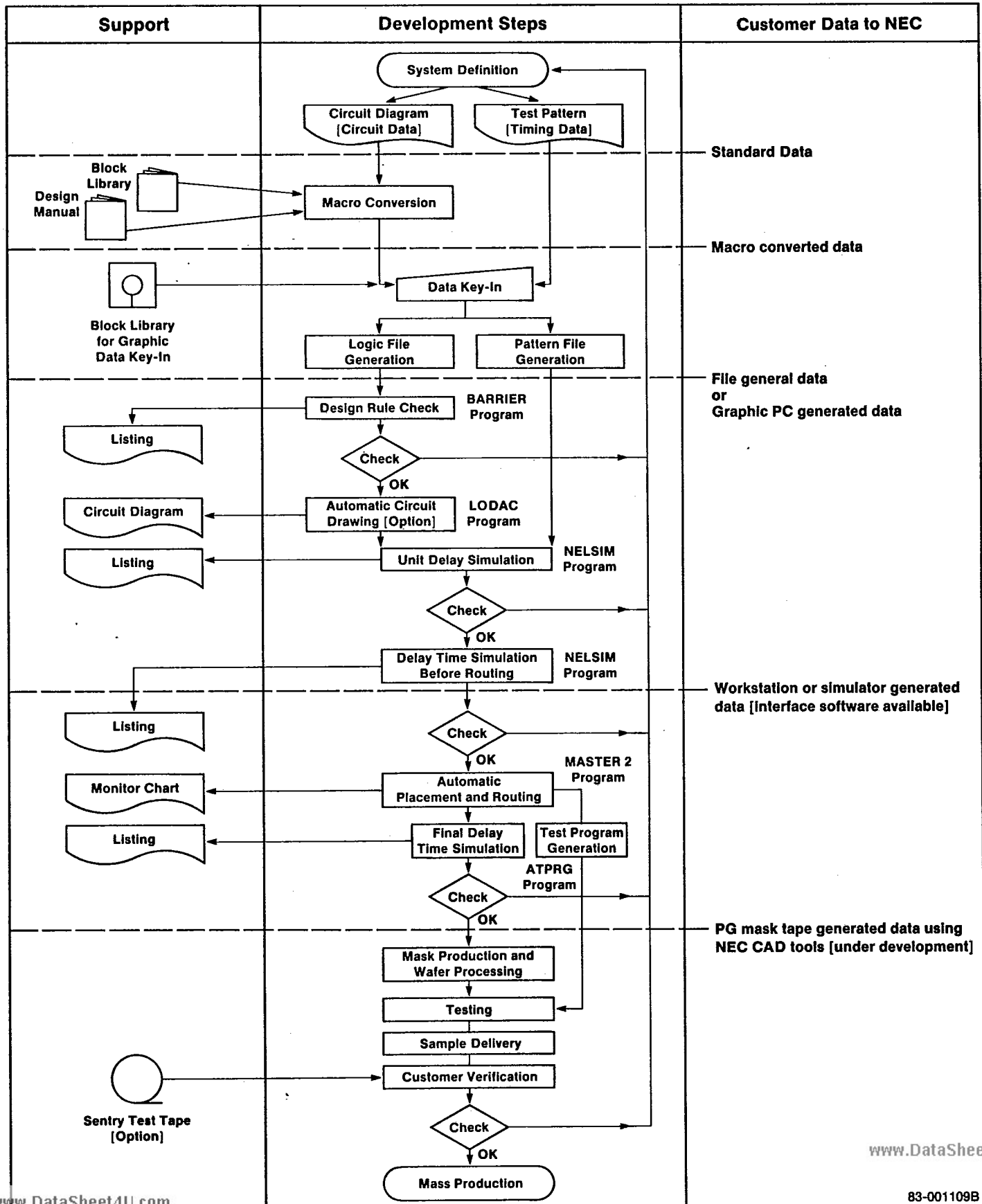

**μPD65000 (CMOS-2) SERIES
3-MICRON**



Development Procedure

The semicustom approach of gate arrays offers a unique and effective method of manufacturing ICs at reduced cost and development time. NEC makes this possible by stocking wafers that are completely fabricated except for the final step of interconnection. This provides a designer the freedom of interconnecting the uncommitted components to achieve a unique circuit configuration.

CMOS-2 Block Library List

Interface Blocks

Block Type	Function
FI01	Input Buffer (CMOS Level)
FI02	Input Buffer (TTL Level)
FI03, FI04	Oscillator block
F001	Output Buffer (Normal)
EXT1	Output Buffer (Nch Open Drain)
EXT2	Output Buffer (Pch Open Drain)
B003	I/O Buffer (Three-State CMOS Level In)
B004	I/O Buffer (Three-State TTL Level In)
B008	Output Buffer (Three-State)

Functional Blocks

Block Type	Function	Cells
Level Generator	F091 H.L. Level Generator	1
Inverter	F101 1-Input (F.O. = 8)	1
	F102 1-Input (F.O. = 16)	1
	F103 1-Input (F.O. = 24)	2
	F104 1-Input (F.O. = 32)	2
Buffer	F111 1-Input (F.O. = 8)	1
	F112 1-Input (F.O. = 16)	2
	F113 1-Input (F.O. = 24)	2
	F114 1-Input (F.O. = 32)	3
NOR	F202 2-Input NOR Gate	1
	F203 3-Input NOR Gate	2
	F204 4-Input NOR Gate	2
	F208 8-Input NOR Gate	7
OR	F212 2-Input OR Gate	2
	F213 3-Input OR Gate	2
	F214 4-Input OR Gate	3

Essential Documents

- Contract and nondisclosure agreement
- Circuit diagram based on the NEC Block Library
- Interconnection data file (LOGINC)
- Test pattern file (NELPAT)
- Pin assignment (if required)
- Critical path identification (if required)

Functional Blocks [cont]

Block Type	Function	Cells	
NAND	F302 2-Input NAND Gate	1	
	F303 3-Input NAND Gate	2	
	F304 4-Input NAND Gate	2	
	F305 5-Input NAND Gate	3	
	F306 6-Input NAND Gate	3	
	F308 8-Input NAND Gate	7	
	AND	F312 2-Input AND Gate	2
		F313 3-Input AND Gate	2
F314 4-Input AND Gate		3	
AND-NOR	F421 2-Wide, 1-2-Input AND-OR-Inverter	2	
	F422 3-Wide, 1-1-2-Input AND-OR-Inverter	2	
	F423 2-Wide, 1-3-Input AND-OR-Inverter	2	
	F424 2-Wide, 2-2-Input AND-OR-Inverter	2	
	F425 3-Wide, 2-2-2-Input AND-OR-Inverter	3	
	F426 2-Wide, 3-3-Input AND-OR-Inverter	3	
	F429 4-Wide, 2-2-2-Input AND-OR-Inverter	4	
	F442 2-Wide, 4-4-Input AND-OR-Inverter	4	
OR-NAND	F431 2-Wide, 1-2-Input OR-AND-Inverter	2	
	F432 2-Wide, 2-2-Input OR-AND-Inverter	2	
	F433 2-Wide, 1-3-Input OR-AND-Inverter	2	
	F434 2-Wide, 2-2-Input OR-AND-Inverter	2	
	F435 2-Wide, 2-3-Input OR-AND-Inverter	3	
	F436 2-Wide, 3-3-Input OR-AND-Inverter	3	
	F454 4-Wide, 2-2-2-Input OR-AND-Inverter	4	
	Driver	F501 Clock Driver	1
F502 Clock Driver (Dual)		2	
F503 Clock Driver (With Buffer)		2	
F504 Clock Driver (Dual with Buffer)		4	
F505 2-Wide, 1-2-Input NAND-AND-Inverter		2	
EX-OR	F511 2-Input Exclusive-OR Gate	3	
EX-NOR	F512 2-Input Exclusive-NOR Gate	3	



Functional Blocks [cont]

	Block Type	Function	Cells	
Full Adder	F521	1 Bit Full Adder	7	
	F523	4-Bit Full Adder	34	
Three-State Buffer	F531	Three-State Buffer (EN) (F.O. = 8)	3	
	F532	Three-State Buffer ($\overline{\text{EN}}$) (F.O. = 8)	3	
	F533	Three-State Buffer (EN) (F.O. = 24)	4	
Multiplexer	F569	8-1 Multiplexer	17	
	F570	4-1 Multiplexer	8	
	F571	2-1 Multiplexer	4	
Parity Generator	F581	8 Bit Odd Parity Generator	18	
	F582	8 Bit Even Parity Generator	18	
Latch	F595	R-S Latch	4	
	F601	D-Latch	3	
	F602	D-Latch (with $\overline{\text{Reset}}$)	4	
	F603	D-Latch (with $\overline{\text{Reset}}$)	4	
	F604	D-Latch $\overline{\text{C}}$	3	
	F605	D-Latch $\overline{\text{C}}$ with $\overline{\text{Reset}}$	4	
	F901	4 Bit D-Latch	10	
	F902	8 Bit D-Latch	18	
	Flip-Flop	F611	D-Type	5
		F612	D-Type with $\overline{\text{Reset}}$	7
F613		D-Type with $\overline{\text{Set}}$	7	
F614		D-Type with $\overline{\text{Set-Reset}}$	7	
F615		D-Type with $\overline{\text{Reset}}$	7	
F616		D-Type with $\overline{\text{Set}}$	7	
F617		D-Type with $\overline{\text{Set-Reset}}$	7	
F631		D-Type $\overline{\text{C}}$	5	
F635		D-Type $\overline{\text{C}}$ with $\overline{\text{Reset}}$	7	
F636		D-Type $\overline{\text{C}}$ with $\overline{\text{Set}}$	7	
F637		D-Type $\overline{\text{C}}$ with $\overline{\text{Set-Reset}}$	7	
F641		D-Type (Buffered Out)	6	
F642		D-Type (Buffered Out) with $\overline{\text{Reset}}$	8	
F643		D-Type (Buffered Out) with $\overline{\text{Set}}$	8	
F644		D-Type (Buffered Out) with $\overline{\text{Set-Reset}}$	8	
F645		D-Type (Buffered Out) with $\overline{\text{Reset}}$	8	
F646		D-Type (Buffered Out) with $\overline{\text{Set}}$	8	
F647		D-Type (Buffered Out) with $\overline{\text{Set-Reset}}$	8	
F661		D-Type (Buffered Out) $\overline{\text{C}}$	6	
F665		D-Type (Buffered Out) $\overline{\text{C}}$ with $\overline{\text{Reset}}$	8	
F666		D-Type (Buffered Out) $\overline{\text{C}}$ with $\overline{\text{Set}}$	8	
F667		D-Type (Buffered Out) $\overline{\text{C}}$ with $\overline{\text{Set-Reset}}$	8	
F922		4 Bit D-Type with $\overline{\text{Reset}}$	26	

	Block Type	Function	Cells
Flip-Flop	F691	Serial/Parallel Shift Register	5
	F911	4 Bit Shift Register with $\overline{\text{Reset}}$	26
	F912	4 Bit Serial/Parallel Shift Register	24
	F913	4 Bit Parallel Shift Register with $\overline{\text{Reset}}$	35
	F712	Toggle with $\overline{\text{Reset}}$	7
	F713	Toggle with $\overline{\text{Set}}$	7
	F714	Toggle with $\overline{\text{Set-Reset}}$	7
	F715	Toggle with $\overline{\text{Reset}}$	7
	F716	Toggle with $\overline{\text{Set}}$	7
	F717	Toggle with $\overline{\text{Set-Reset}}$	7
	F735	Toggle ($\overline{\text{T}}$) with $\overline{\text{Reset}}$	7
	F736	Toggle ($\overline{\text{T}}$) with $\overline{\text{Set}}$	7
	F737	Toggle ($\overline{\text{T}}$) with $\overline{\text{Set-Reset}}$	7
	F742	Toggle (Buffered Out) with $\overline{\text{Reset}}$	8
	F743	Toggle (Buffered Out) with $\overline{\text{Set}}$	8
	F744	Toggle (Buffered Out) with $\overline{\text{Set-Reset}}$	8
	F745	Toggle (Buffered Out) with $\overline{\text{Reset}}$	8
	F746	Toggle (Buffered Out) with $\overline{\text{Set}}$	8
	F747	Toggle (Buffered Out) with $\overline{\text{Set-Reset}}$	8
	F765	Toggle (Buffered Out) ($\overline{\text{T}}$) with $\overline{\text{Reset}}$	8
	F766	Toggle (Buffered Out) ($\overline{\text{T}}$) with $\overline{\text{Set}}$	8
	F767	Toggle (Buffered Out) ($\overline{\text{T}}$) with $\overline{\text{Set-Reset}}$	8
	F791	Toggle with $\overline{\text{Set-Reset}}$ and $\overline{\text{Tog-EN}}$	9
	F792	Toggle ($\overline{\text{T}}$) with $\overline{\text{Set-Reset}}$ and $\overline{\text{Tog-EN}}$	9
	F771	JK F/F	9
	F772	JK F/F with $\overline{\text{Reset}}$	11
	F773	JK F/F with $\overline{\text{Set}}$	11
F774	JK F/F with $\overline{\text{Set-Reset}}$	11	
F775	JK F/F with $\overline{\text{Reset}}$	11	
F776	JK F/F with $\overline{\text{Set}}$	11	
F777	JK F/F with $\overline{\text{Set-Reset}}$	11	
F781	JK F/F $\overline{\text{C}}$	9	
F785	JK F/F $\overline{\text{C}}$ with $\overline{\text{Reset}}$	11	
F786	JK F/F $\overline{\text{C}}$ with $\overline{\text{Set}}$	11	
F787	JK F/F $\overline{\text{C}}$ with $\overline{\text{Set-Reset}}$	11	
Counter	F961	4-Bit Sync Binary Counter with $\overline{\text{Reset}}$	54
	F962	4-Bit Sync Binary Counter with $\overline{\text{Reset}}$	34
Decoder	F981	2-to-4 Decoder with $\overline{\text{EN}}$	9
	F982	3-to-8 Decoder with $\overline{\text{EN}}$	20
Comparator	F985	4-Bit Magnitude Comparator	46
Misc	BUSA	Bus Array	

**μPD65000 (CMOS-2) SERIES
3-MICRON**



Operating Characteristics

Output Voltage vs Input Voltage [CMOS Input]

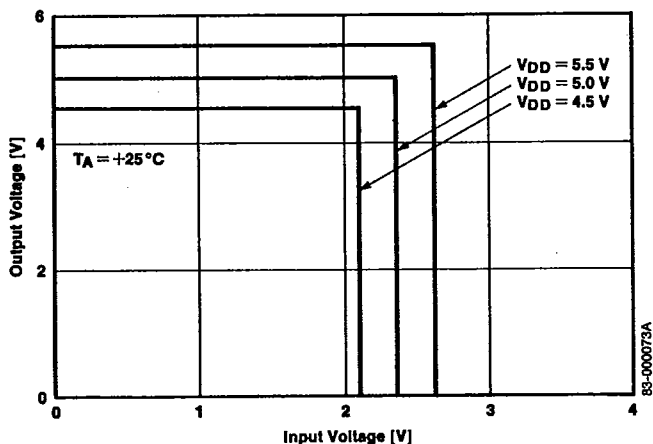

Output Voltage vs Input Voltage [TTL Input]

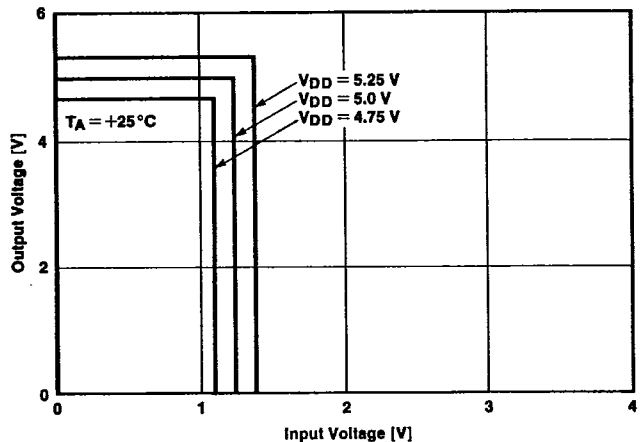

Output Current vs Output Voltage [N-Channel]

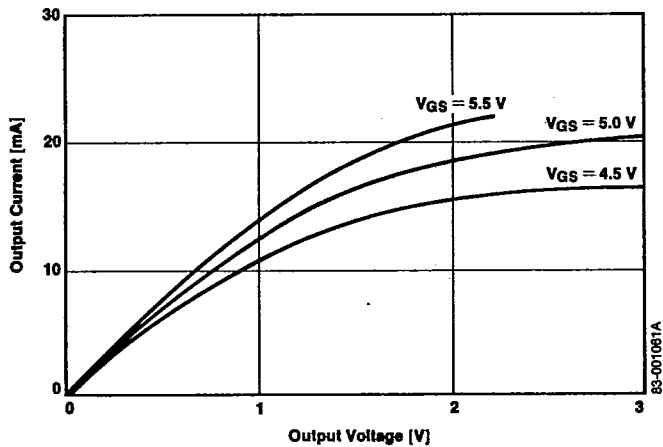

Output Current vs Output Voltage [P-Channel]

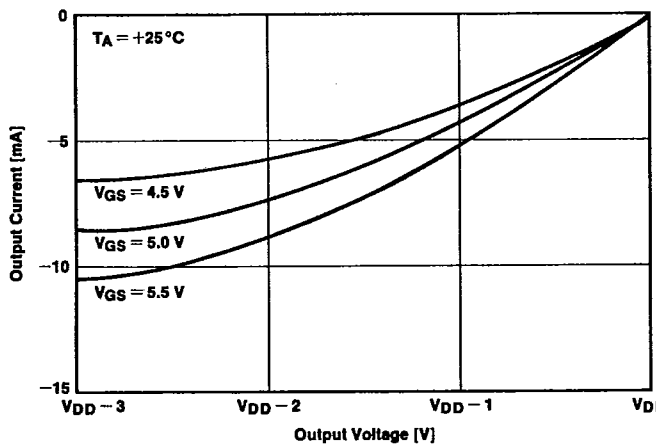

Delay Time vs Fan-Outs [NAND]

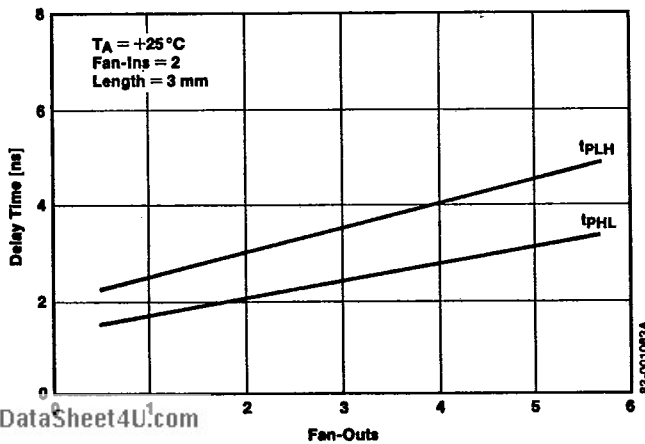

Delay Time vs Fan-Outs [NOR]

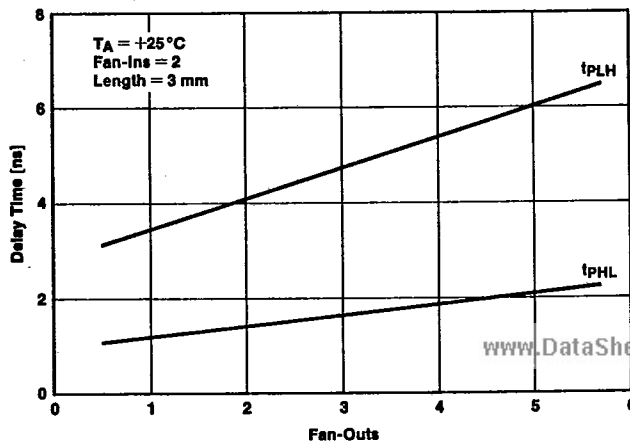

Operating Characteristics (cont)

Delay Time vs Length [NAND]

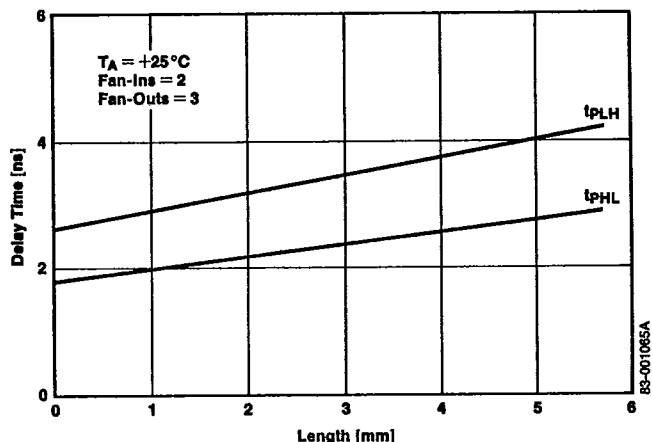

Delay Time vs Length [NOR]

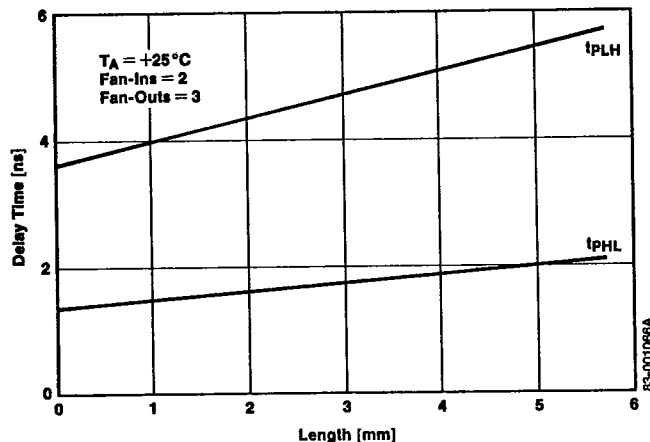

Delay Time vs Supply Voltage [NAND]

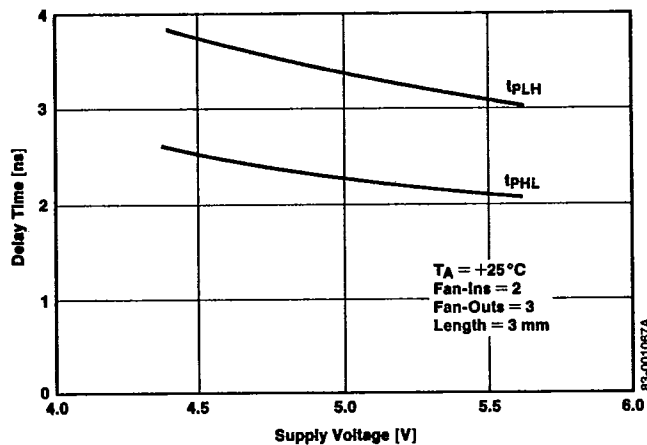

Delay Time vs Ambient Temperature [NAND]

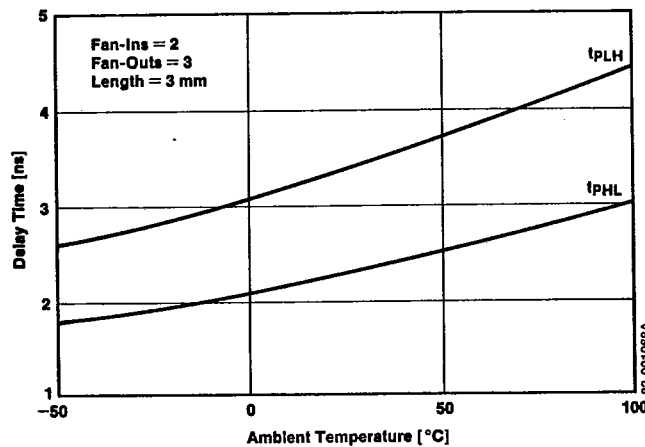

Delay Time vs Supply Voltage [Input Buffer]

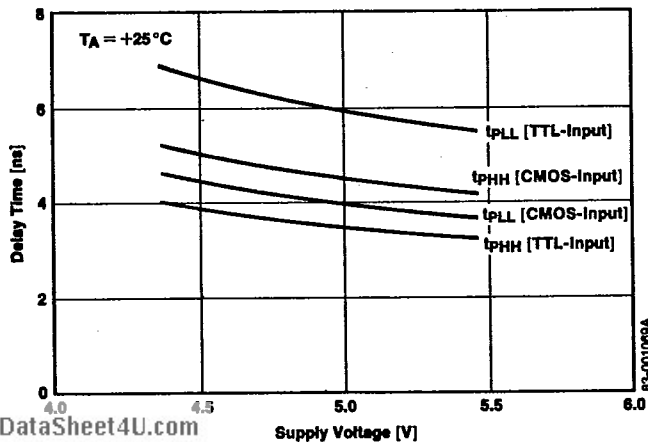

Delay Time vs Load Capacitance [Output Buffer]

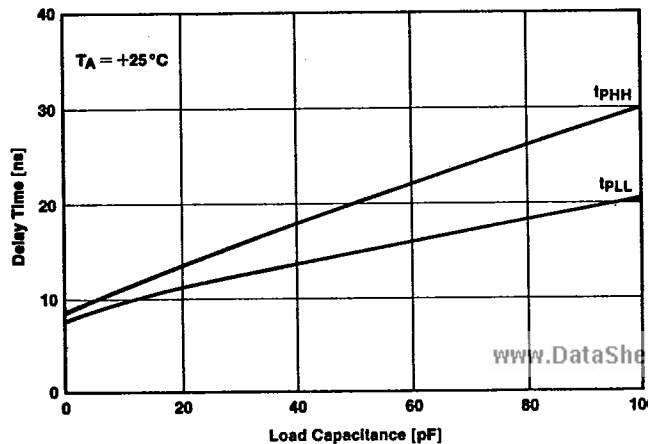

**μPD65000 (CMOS-2) SERIES
3-MICRON**



Operating Characteristics (cont)

Delay Time vs Fan-Ins [NAND]

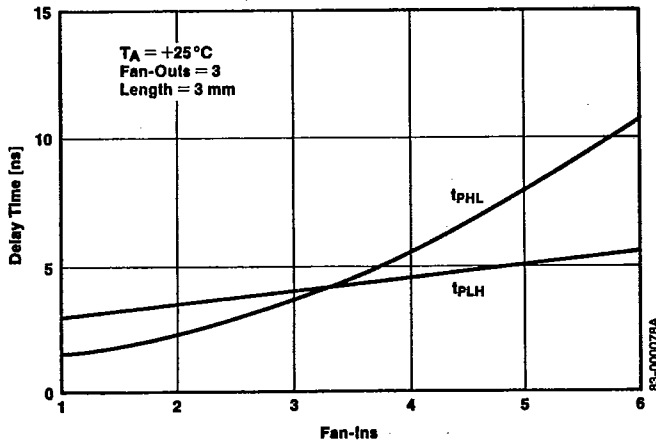

Delay Time vs Fan-Ins [NOR]

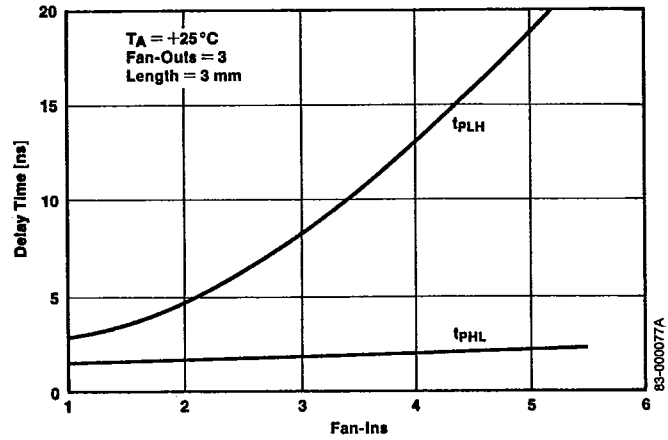

Power Dissipation vs Load Capacitance [Output Buffer]

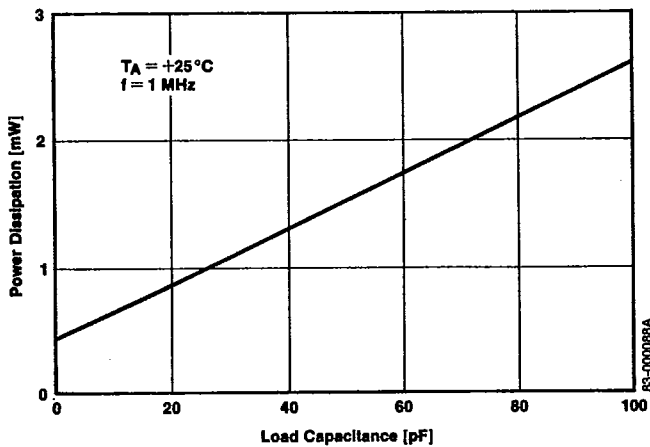

Rise and Fall Times vs Load Capacitance [Output Buffer]

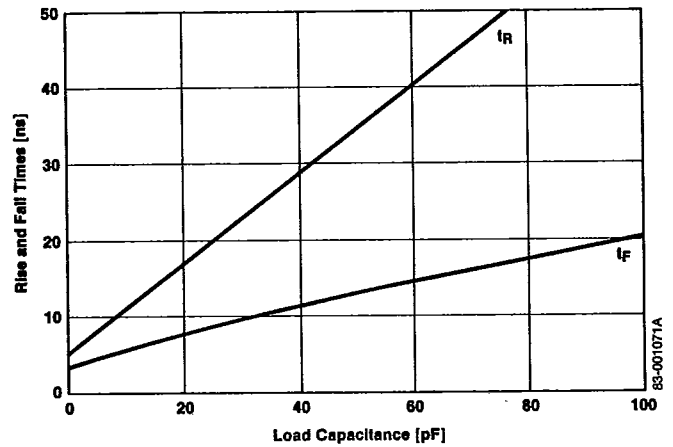



**μPD65000 (CMOS-2) SERIES
3-MICRON**

www.DataSheet4U.com

Packaging Information

The 3-micron gate arrays are available in a wide variety of packages to accommodate unique applications. The following table shows the package types in the μPD65000 (CMOS-2) series. (DIP = Dual in-line package; QIP = Quad in-line package; PGA = Pin grid array.)

Package Availability

Package Type	μPD65003	μPD65002	μPD65010	μPD65020
DIP				
16-Pin	•			
18-Pin	•			
20-Pin	•			
24-Pin	•	•	•	
28-Pin	•	•	•	•
40-Pin	•	•	•	•
48-Pin		•	•	•
64-Pin (shrink)			•	•
QIP				
64-Pin			•	•
Flat				
44-Pin	•	•	•	•
52-Pin		•	•	•
64-Pin			•	•
80-Pin			•	•
100-Pin				•
PGA				
72-Pin				•

Package Marking

Example of Plastic Package

