



Digital Temperature Sensor with SST Interface

ADT7484A/ADT7486A

FEATURES

- 1 on-chip temperature sensor
- 1 or 2 remote temperature sensors
- Simple Serial Transport™ (SST™) interface Rev 1 compliant

APPLICATIONS

- Personal computers
- Portable personal devices
- Industrial sensor nets

GENERAL DESCRIPTION

The ADT7484A/ADT7486A are simple digital temperature sensors for use in PC applications with a Simple Serial Transport (SST) interface. These devices can monitor their own temperature as well as the temperature of one (ADT7484A) or two (ADT7486A) remote sensor diodes. The ADT7484A/ADT7486A are controlled by a single SST bidirectional data line. The devices are fixed-address SST clients where the target address is chosen by the state of the two address pins, ADD0 and ADD1.

FUNCTIONAL BLOCK DIAGRAM

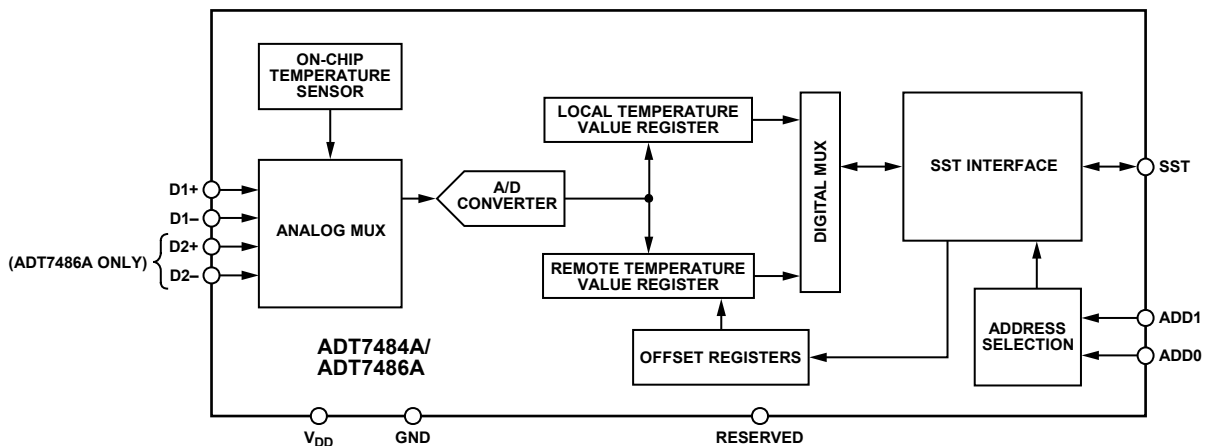

Figure 1.

05198-001

Rev. 0

Information furnished by Analog Devices is believed to be accurate and reliable. However, no responsibility is assumed by Analog Devices for its use, nor for any infringements of patents or other rights of third parties that may result from its use. Specifications subject to change without notice. No license is granted by implication or otherwise under any patent or patent rights of Analog Devices. Trademarks and registered trademarks are the property of their respective owners.

One Technology Way, P.O. Box 9106, Norwood, MA 02062-9106, U.S.A.
Tel: 781.329.4700
Fax: 781.461.3113

©2006 Analog Devices, Inc. All rights reserved.

ADT7484A/ADT7486A

TABLE OF CONTENTS

Features	1	SST Interface	9
Applications.....	1	Temperature Measurement	12
General Description	1	Temperature Measurement Method	12
Functional Block Diagram	1	Reading Temperature Measurements	12
Revision History	2	SST Temperature Sensor Data Format	13
Specifications.....	3	Using Discrete Transistors	13
Absolute Maximum Ratings.....	5	Layout Considerations.....	13
Thermal Resistance	5	Temperature Offset	14
ESD Caution.....	5	Application Schematics	14
Pin Configurations and Functional Descriptions	6	Outline Dimensions	15
Typical Performance Characteristics	7	Ordering Guide	15
Product Description	9		

REVISION HISTORY

7/06—Revision 0: Initial Version

SPECIFICATIONS

$T_A = T_{MIN}$ to T_{MAX} , $V_{CC} = V_{MIN}$ to V_{MAX} , unless otherwise noted.

Table 1.

Parameter	Min	Typ	Max	Unit	Test Conditions/Comments
POWER SUPPLY					
Supply Voltage, V_{CC}	3.0	3.3	3.6	V	
Undervoltage Lockout Threshold		2.8		V	
Average Operating Supply Current, I_{DD}		3.8	5	mA	Continuous conversions
TEMPERATURE-TO-DIGITAL CONVERTER					
Local Sensor Accuracy		+1	± 1.75	$^{\circ}\text{C}$	$40^{\circ}\text{C} \leq T_A \leq 70^{\circ}\text{C}$, $V_{CC} = 3.3\text{ V} \pm 5\%$
			± 4	$^{\circ}\text{C}$	$-40^{\circ}\text{C} \leq T_A \leq +100^{\circ}\text{C}$
Remote Sensor Accuracy			± 1	$^{\circ}\text{C}$	$-40^{\circ}\text{C} \leq T_D \leq +125^{\circ}\text{C}$; $T_A = 25^{\circ}\text{C}$; $V_{CC} = 3.3\text{ V}$
		+1	± 1.75	$^{\circ}\text{C}$	$-40^{\circ}\text{C} \leq T_D \leq +125^{\circ}\text{C}$; $-40 \leq T_A \leq 70^{\circ}\text{C}$, $V_{CC} = 3.3\text{ V} \pm 5\%$
			± 4	$^{\circ}\text{C}$	$-40^{\circ}\text{C} \leq T_D \leq +125^{\circ}\text{C}$; $-40 \leq T_A \leq +100^{\circ}\text{C}$
Remote Sensor Source Current		12		μA	Low level
		80		μA	Mid level
		204		μA	High level
Resolution		0.016		$^{\circ}\text{C}$	
Series Resistance Cancellation		1.5		k Ω	The ADT7484A and ADT7486A cancel 1.5 k Ω in series with the remote thermal diode
Conversion Time (Local Temperature) ¹			12	ms	Averaging enabled
Conversion Time (Remote Temperature) ¹			38	ms	Averaging enabled
Total Monitoring Cycle Time ¹			50	ms	Averaging enabled
DIGITAL INPUTS (ADD0, ADD1)					
Input High Voltage, V_{IH}	2.3			V	
Input Low Voltage, V_{IL}			0.8	V	
Input High Current, I_{IH}	-1			μA	$V_{IN} = V_{CC}$
Input Low Current, I_{IL}			1	μA	$V_{IN} = 0$
Pin Capacitance		5		pF	
DIGITAL I/O (SST Pin)					
Input High Voltage, V_{IH}	1.1			V	
Input Low Voltage, V_{IL}			0.4	V	
Hysteresis ¹		150		mV	Between input switching levels
Output High Voltage, V_{OH}	1.1		1.9	V	$I_{SOURCE} = 6\text{ mA}$ (maximum)
High Impedance State Leakage, I_{LEAK}			± 1	μA	Device powered on SST bus; $V_{SST} = 1.1\text{ V}$, $V_{CC} = 3.3\text{ V}$
High Impedance State Leakage, I_{LEAK}			± 10	μA	Device unpowered on SST bus; $V_{SST} = 1.1\text{ V}$, $V_{CC} = 0\text{ V}$
Signal Noise Immunity, V_{NOISE}	300			mV p-p	Noise glitches from 10 MHz to 100 MHz; width up to 50 ns
SST TIMING					
Bitwise Period, t_{BIT}	0.495		500	μs	
High Level Time for Logic 1, t_{H1} ²	$0.6 \times t_{BIT}$	$0.75 \times t_{BIT}$	$0.8 \times t_{BIT}$	μs	t_{BIT} defined in speed negotiation
High Level Time for Logic 0, t_{H0} ²	$0.2 \times t_{BIT}$	$0.25 \times t_{BIT}$	$0.4 \times t_{BIT}$	μs	
Time to Assert SST High for Logic 1, $t_{SU,HIGH}$			$0.2 \times t_{BIT}$	μs	
Hold Time, t_{HOLD} ³			$0.5 \times t_{BIT-M}$	μs	See SST Specification Rev 1.0
Stop Time, t_{STOP}	$1.25 \times t_{BIT}$	$2 \times t_{BIT}$	$2 \times t_{BIT}$	μs	Device responding to a constant low level driven by originator

ADT7484A/ADT7486A

Parameter	Min	Typ	Max	Unit	Test Conditions/Comments
Time to Respond After a Reset, t_{RESET}			0.4	ms	
Response Time to Speed Negotiation After Power-Up		500		μs	Time after power-up when device can participate in speed negotiation

¹ Guaranteed by design, not production tested.

² Minimum and maximum bit times are relative to t_{BIT} defined in the timing negotiation pulse.

³ Devices compatible with hold time specification as driven by SST originator.

ABSOLUTE MAXIMUM RATINGS

Table 2.

Parameter	Rating
Supply Voltage (V_{CC})	3.6 V
Voltage on Any Other Pin (Including SST Pin)	3.6 V
Input Current at Any Pin	± 5 mA
Package Input Current	± 20 mA
Maximum Junction Temperature (T_J max)	150°C
Storage Temperature Range	-65°C to +150°C
Lead Temperature, Soldering	
IR Peak Reflow Temperature	260°C
Lead Temperature (10 sec)	300°C
ESD Rating	1500 V

Stresses above those listed under Absolute Maximum Ratings may cause permanent damage to the device. This is a stress rating only; functional operation of the device at these or any other conditions above those indicated in the operational section of this specification is not implied. Exposure to absolute maximum rating conditions for extended periods may affect device reliability.

THERMAL RESISTANCE

θ_{JA} is specified for the worst-case conditions, that is, a device soldered in a circuit board for surface-mount packages.

Table 3. Thermal Resistance

Package Type	θ_{JA}	θ_{JC}	Unit
8-Lead MSOP (ADT7484A)	206	44	°C/W
10-Lead MSOP (ADT7486A)	206	44	°C/W

ESD CAUTION

ESD (electrostatic discharge) sensitive device. Electrostatic charges as high as 4000 V readily accumulate on the human body and test equipment and can discharge without detection. Although this product features proprietary ESD protection circuitry, permanent damage may occur on devices subjected to high energy electrostatic discharges. Therefore, proper ESD precautions are recommended to avoid performance degradation or loss of functionality.



ADT7484A/ADT7486A

PIN CONFIGURATIONS AND FUNCTIONAL DESCRIPTIONS

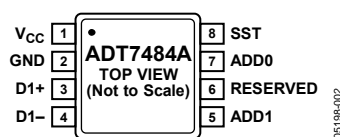

Figure 2. ADT7484A 8-Lead MSOP

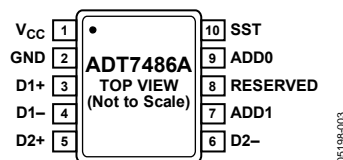

Figure 3. ADT7486A 10-Lead MSOP

Table 4. ADT7484A Pin Function Descriptions

Pin No.	Mnemonic	Type	Description
1	V _{CC}	Power supply	3.3 V ± 10%.
2	GND	Ground	Ground Pin.
3	D1+	Analog input	Positive Connection to Remote Temperature Sensor.
4	D1-	Analog input	Negative Connection to Remote Temperature Sensor.
5	ADD1	Digital input	SST Address Select.
6	RESERVED	Reserved	Connect to Ground.
7	ADD0	Digital input	SST Address Select.
8	SST	Digital input/output	SST Bidirectional Data Line.

Table 5. ADT7486A Pin Function Descriptions

Pin No.	Mnemonic	Type	Description
1	V _{CC}	Power supply	3.3 V ± 10%.
2	GND	Ground	Ground Pin.
3	D1+	Analog input	Positive Connection to Remote 1 Temperature Sensor.
4	D1-	Analog input	Negative Connection to Remote 1 Temperature Sensor.
5	D2+	Analog input	Positive Connection to Remote 2 Temperature Sensor.
6	D2-	Analog input	Negative Connection to Remote 2 Temperature Sensor.
7	ADD1	Analog input	SST Address Select.
8	RESERVED	Analog input	Connect to Ground.
9	ADD0	Digital input	SST Address Select.
10	SST	Digital input/output	SST Bidirectional Data Line.

TYPICAL PERFORMANCE CHARACTERISTICS

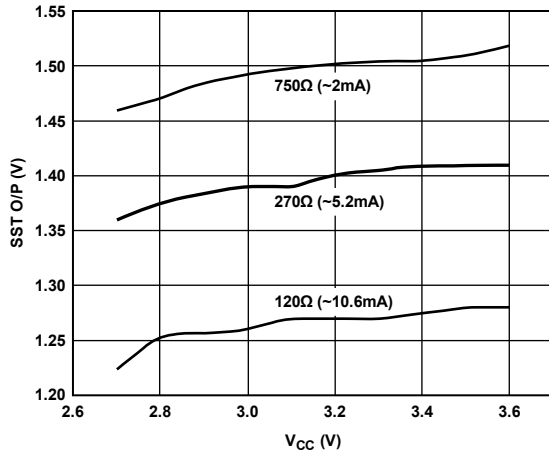

Figure 4. SST O/P Level vs. Supply Voltage

05198-009

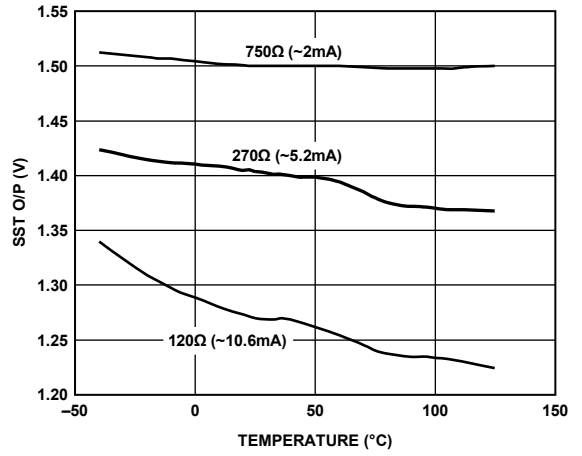

Figure 7. SST O/P Level vs. Temperature

05198-011

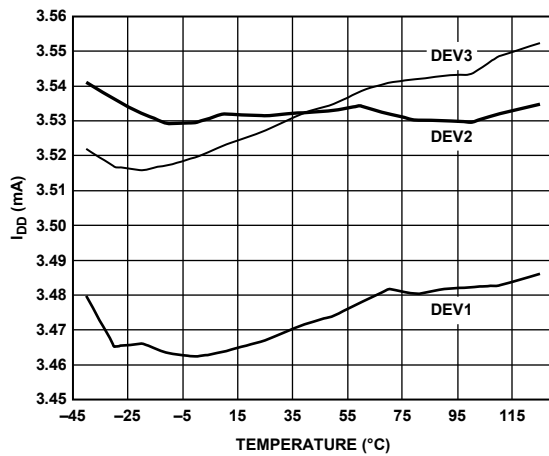

Figure 5. Supply Current vs. Temperature

05198-010

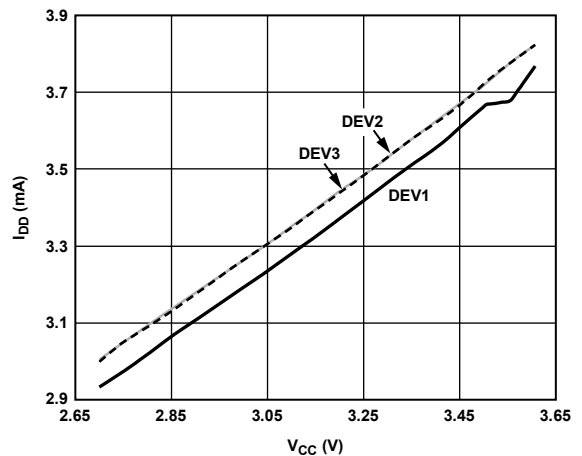

Figure 8. Supply Current vs. Voltage

05198-012

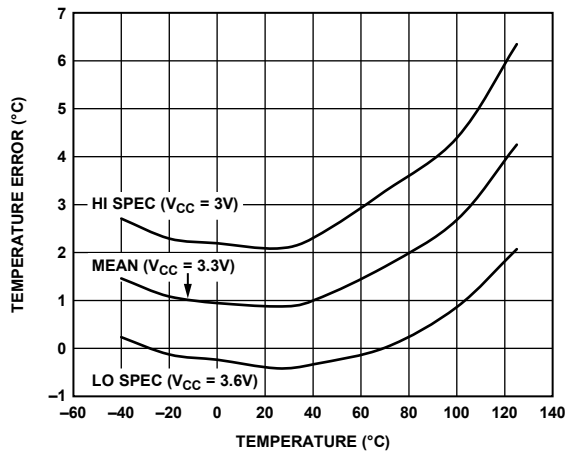

Figure 6. Local Temperature Error

05198-018

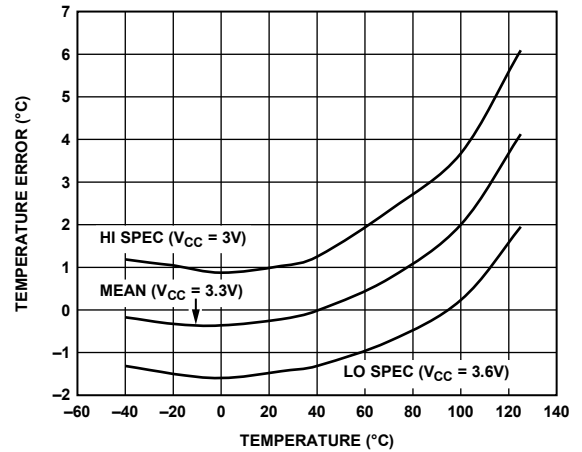

Figure 9. Remote Temperature Error

05198-019

ADT7484A/ADT7486A

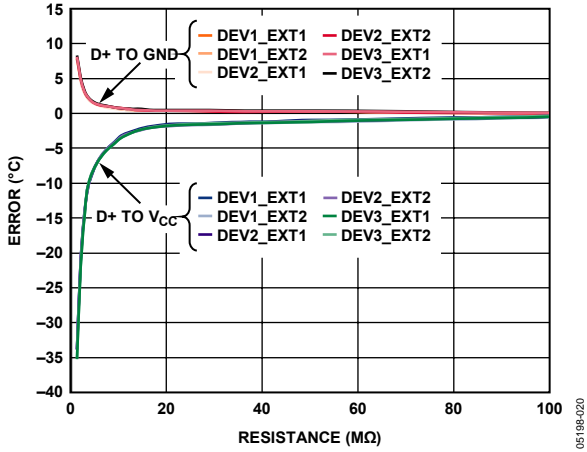

Figure 10. Remote Temperature Error vs. PCB Resistance

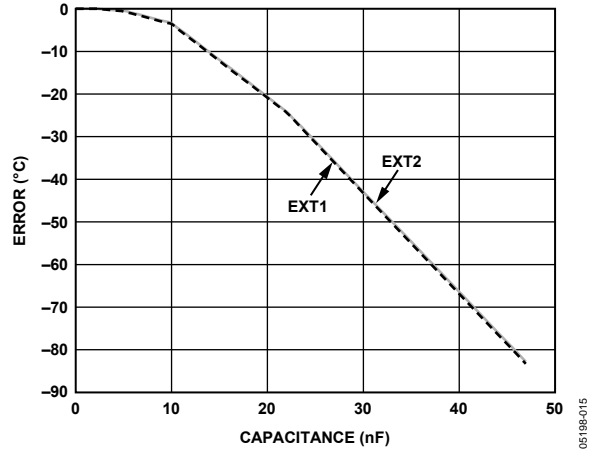

Figure 13. Remote Temperature Error vs. Capacitance Between D1+ and D1-

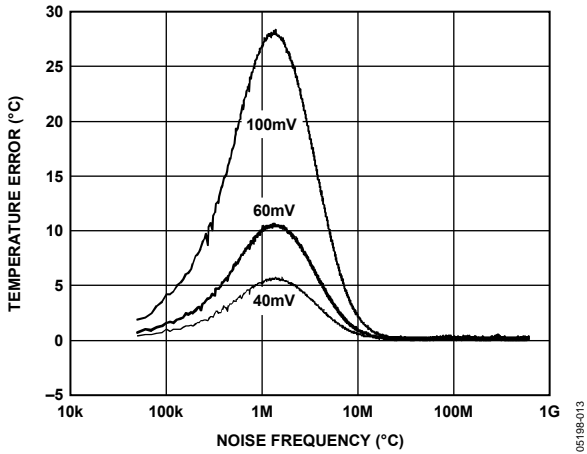

Figure 11. Temperature Error vs. Common-Mode Noise Frequency

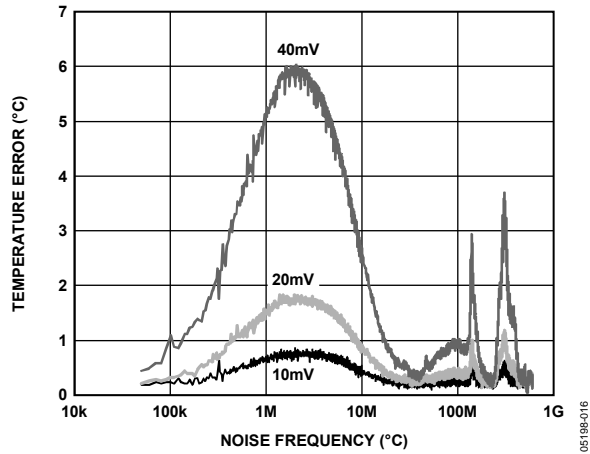

Figure 14. Temperature Error vs. Differential-Mode Noise Frequency

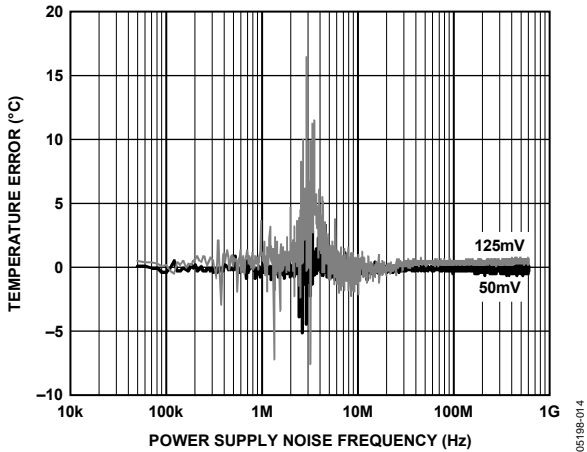

Figure 12. Local Temperature Error vs. Power Supply Noise

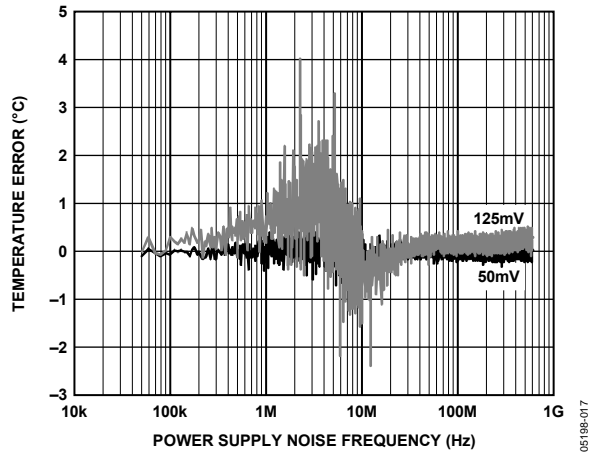

Figure 15. Remote Temperature Error vs. Power Supply Noise

PRODUCT DESCRIPTION

The ADT7484A is a single remote temperature sensor, and the ADT7486A is a dual temperature sensor for use in PC applications. The ADT7484A/ADT7486A accurately measure local and remote temperature and communicate over a one-wire Simple Serial Transport (SST) bus interface.

SST INTERFACE

Simple Serial Transport (SST) is a one-wire serial bus and a communications protocol between components intended for use in personal computers, personal handheld devices, or other industrial sensor nets. The ADT7484A/ADT7486A support SST specification Rev 1.

SST is a licensable bus technology from Analog Devices, Inc., and Intel Corporation. To inquire about obtaining a copy of the Simple Serial Transport Specification or an SST technology license, please email Analog Devices, at sss_licensing@analog.com or write to Analog Devices, 3550 North First Street, San Jose, CA 95134, Attention: SST Licensing, M/S B7-24.

ADT7484A/ADT7486A Client Address

The client address for the ADT7484A/ADT7486A is selected using the address pin. The address pin is connected to a float detection circuit, which allows the ADT7484A/ADT7486A to distinguish between three input states: high, low (GND), and floating. The address range for fixed address, discoverable devices is 0x48 to 0x50.

Table 6. ADT7484A/ADT7486A Selectable Addresses

ADD1	ADD0	Address Selected
Low (GND)	Low (GND)	0x48
Low (GND)	Float	0x49
Low (GND)	High	0x4A
Float	Low (GND)	0x4B
Float	Float	0x4C
Float	High	0x4D
High	Low (GND)	0x4E
High	Float	0x4F
High	High	0x50

ADT7484A/ADT7486A

Command Summary

Table 7 summarizes the commands supported by the ADT7484A/ADT7486A devices when directed at the target address selected by the fixed address pins. It contains the command name, command code (CC), write data length (WL), read data length (RL), and a brief description.

Table 7. Command Code Summary

Command	Command Code, CC	Write Length, WL	Read Length, RL	Description
Ping()	0x00	0x00	0x00	Shows a nonzero FCS over the header if present.
GetIntTemp()	0x00	0x01	0x02	Shows the temperature of the device's internal thermal diode.
GetExt1Temp()	0x01	0x01	0x02	Shows the temperature of External Thermal Diode 1.
GetExt2Temp()	0x02	0x01	0x02	Shows the temperature of External Thermal Diode 2 (ADT7486A only).
GetAllTemps()	0x00	0x01	0x04 (ADT7484A) 0x06 (ADT7486A)	Shows a 4- or 6-byte block of data (ADT7484A: GetIntTemp, GetExt1Temp; ADT7486A: GetIntTemp, GetExt1Temp, GetExt2Temp).
SetExt1Offset()	0xe0	0x03	0x00	Sets the offset used to correct errors in External Diode 1.
GetExt1Offset()	0xe0	0x01	0x02	Shows the offset that the device is using to correct errors in External Diode 1.
SetExt2Offset()	0xe1	0x03	0x00	Sets the offset used to correct errors in External Diode 2 (ADT7486A only).
GetExt2Offset()	0xe1	0x01	0x02	Shows the offset that the device is using to correct errors in External Diode 2 (ADT7486A only).
ResetDevice()	0xf6	0x01	0x00	Functional reset. The ADT7484A/ADT7486A also respond to this command when directed to the Target Address 0x00.
GetDIB()	0xf7 0xf7	0x01 0x01	0x08 0x10	Shows information used by SW to identify the device's capabilities. Can be in 8- or 16-byte format.

Command Code Details**ADT7484A/ADT7486A Device Identifier Block**

The GetDIB() command retrieves the device identifier block (DIB), which provides information to identify the capabilities of the ADT7484A/ADT7486A. The data returned can be in 8- or 16-byte format. The full 16 bytes of DIB is detailed in Table 8. The 8-byte format involves the first eight bytes described in this table. Byte-sized data is returned in the respective fields as it appears in Table 8. Word-sized data, including vendor ID, device ID, and data values use little endian format, that is, the LSB is returned first, followed by the MSB.

Table 8. DIB Byte Details

Byte	Name	Value	Description
0	Device Capabilities	0xc0	Fixed address device
1	Version/Revision	0x10	Meets Version 1 of the SST specification
2, 3	Vendor ID	00x11d4	Contains company ID number in little endian format
4, 5	Device ID	0x7484 or 0x7486	Contains device ID number in little endian format
6	Device Interface	0x01	SST device
7	Function Interface	0x00	Reserved
8	Reserved	0x00	Reserved
9	Reserved	0x00	Reserved
10	Reserved	0x00	Reserved
11	Reserved	0x00	Reserved
12	Reserved	0x00	Reserved
13	Reserved	0x00	Reserved
14	Revision ID	0x05	Contains revision ID
15	Client Device Address	0x48 to 0x50	Dependent on the state of the address pins

Ping()

The Ping() command verifies if a device is responding at a particular address. The ADT7484A/ADT7486A show a valid nonzero FCS in response to the Ping() command when correctly addressed.

Table 9. Ping() Command

Target Address	Write Length	Read Length	FCS
Device Address	0x00	0x00	

ResetDevice()

This command resets the register map and conversion controller. The reset command can be global or directed at the client address of the ADT7484A/ADT7486A.

Table 10. ResetDevice() Command

Target Address	Write Length	Read Length	Reset command	FCS
Device Address	0x01	0x00	0xf6	

GetIntTemp()

The ADT7484A/ADT7486A show the local temperature of the device in response to the GetIntTemp() command. The data has a little endian, 16-bit, twos complement format.

GetExtTemp()

Prompted by the GetExtTemp() command, the ADT7484A/ADT7486A show the temperature of the remote diode in little endian, 16-bit, twos complement format. The ADT7484A/ADT7486A show 0x8000 in response to this command if the external diode is an open or short circuit.

GetAllTemps()

The ADT7484A shows the local and remote temperatures in a 4-byte block of data (internal temperature first, followed by External Temperature 1) in response to a GetAllTemps() command. The ADT7486A shows the local and remote temperatures in a 6-byte block of data (internal temperature first, followed by External Temperature 1 and External Temperature 2) in response to this command.

SetExtOffset()

This command sets the offset that the ADT7484A/ADT7486A will use to correct errors in the external diode. The offset is set in little endian, 16-bit, twos complement format. The maximum offset is $\pm 128^{\circ}\text{C}$ with $+0.25^{\circ}\text{C}$ resolution.

GetExtOffset()

This command causes the ADT7484A/ADT7486A to show the offset that they are using to correct errors in the external diode. The offset value is returned in little endian format, that is, LSB before MSB.

ADT7484A/ADT7486A Response to Unsupported Commands

A full list of command codes supported by the ADT7484A/ADT7486A is given in Table 7. The offset registers (Command Codes 0xe0 and 0xe1) are the only registers that the user can write to. The other defined registers are read only. Writing to Register Addresses 0x03 to 0xdf shows a valid FSC, but no action is taken by the ADT7484A/ADT7486A. The ADT7484A/ADT7486A show an invalid FSC if the user attempts to write to the devices between Command Codes 0xe2 to 0xee and no data is written to the device. These registers are reserved for the manufacturer's use only, and no data can be written to the device via these addresses.

ADT7484A/ADT7486A

TEMPERATURE MEASUREMENT

The ADT7484A/ADT7486A each have two dedicated temperature measurement channels: one for measuring the temperature of an on-chip band gap temperature sensor, and one for measuring the temperature of a remote diode, usually located in the CPU or GPU.

The ADT7484A monitors one local and one remote temperature channel, whereas the ADT7486A monitors one local and two remote temperature channels. Monitoring of each of the channels is done in a round-robin sequence. The monitoring sequence is in the order shown in Table 11.

Table 11. Temperature Monitoring Sequence

Channel Number	Measurement	Conversion Time (ms)
0	Local temperature	12
1	Remote Temperature 1	38
2	Remote Temperature 2 (ADT7486A only)	38

TEMPERATURE MEASUREMENT METHOD

A simple method for measuring temperature is to exploit the negative temperature coefficient of a diode by measuring the base-emitter voltage (V_{BE}) of a transistor operated at constant current. Unfortunately, this technique requires calibration to null the effect of the absolute value of V_{BE} , which varies from device to device.

The technique used in the ADT7484A/ADT7486A measures the change in V_{BE} when the device is operated at three different currents.

Figure 16 shows the input signal conditioning used to measure the output of a remote temperature sensor. This figure shows the remote sensor as a substrate transistor, which is provided for temperature monitoring on some microprocessors, but it could also be a discrete transistor. If a discrete transistor is used, the collector is not grounded and should be linked to the base. To prevent ground noise from interfering with the measurement, the more negative terminal of the sensor is not referenced to ground, but is biased above ground by an internal diode at the D1- input. If the sensor is operating in an extremely noisy environment, C1 can be added as a noise filter. Its value should not exceed 1000 pF.

To measure ΔV_{BE} , the operating current through the sensor is switched between three related currents. Figure 16 shows $N1 \times I$ and $N2 \times I$ as different multiples of the current I . The currents through the temperature diode are switched between I and $N1 \times I$, giving ΔV_{BE1} , and then between I and $N2 \times I$, giving ΔV_{BE2} . The temperature can then be calculated using the two ΔV_{BE} measurements. This method can also cancel the effect of series resistance on the temperature measurement. The resulting ΔV_{BE} waveforms are passed through a 65 kHz low-pass filter to remove noise and then through a chopper-stabilized amplifier to amplify and rectify the waveform, producing a dc voltage proportional to ΔV_{BE} . The ADC digitizes this voltage, and a temperature measurement is produced. To reduce the effects of noise, digital filtering is performed by averaging the results of 16 measurement cycles for low conversion rates. Signal conditioning and measurement of the internal temperature sensor is performed in the same manner.

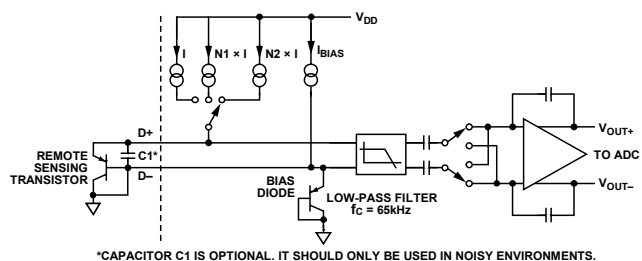

Figure 16. Signal Conditioning for Remote Diode Temperature Sensors

READING TEMPERATURE MEASUREMENTS

The temperature measurement command codes are detailed in Table 12. The temperature data returned is two bytes in little endian format, that is, LSB before MSB. All temperatures can be read together by using Command Code 0x00 with a read length of 0x04. The command codes and returned data are described in Table 12.

Table 12. Temperature Channel Command Codes

Temp Channel	Command Code	Returned data
Internal	0x00	LSB, MSB
External 1	0x01	LSB, MSB
External 2	0x02	LSB, MSB
All Temps	0x00	Internal LSB, Internal MSB; External 1 LSB, External 1 MSB; External 2 LSB, External 2 MSB

SST TEMPERATURE SENSOR DATA FORMAT

The data for temperature is structured to allow values in the range of $\pm 512^{\circ}\text{C}$ to be reported. Thus, the temperature sensor format uses a twos complement, 16-bit binary value to represent values in this range. This format allows temperatures to be represented with approximately a 0.016°C resolution.

Table 13. SST Temperature Data Format

Temperature ($^{\circ}\text{C}$)	Twos Complement	
	MSB	LSB
-125	1110 0000	1100 0000
-80	1110 1100	0000 0000
-40	1111 0110	0000 0000
-20	1111 1011	0011 1110
-5	1111 1110	1100 0000
-1	1111 1111	1100 0000
0	0000 0000	0000 0000
+1	0000 0000	0100 0000
+5	0000 0001	0100 0000
+20	0000 0100	1100 0010
+40	0000 1010	0000 0000
+80	0001 0100	0000 0000
+125	0001 1111	0100 0000

USING DISCRETE TRANSISTORS

If a discrete transistor is used, the collector is not grounded and should be linked to the base. If a PNP transistor is used, the base is connected to the D1- input and the emitter is connected to the D1+ input. If an NPN transistor is used, the emitter is connected to the D1- input and the base is connected to the D1+ input. Figure 17 shows how to connect the ADT7484A/ADT7486A to an NPN or PNP transistor for temperature measurement. To prevent ground noise from interfering with the measurement, the more negative terminal of the sensor is not referenced to ground, but is biased above ground by an internal diode at the D1- input.

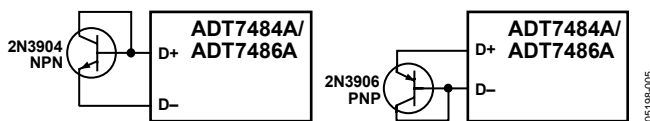

Figure 17. Connections for NPN and PNP Transistors

The ADT7484A/ADT7486A show an external temperature value of $0x8000$ if the external diode is an open or short circuit.

LAYOUT CONSIDERATIONS

Digital boards can be electrically noisy environments. Take the following precautions to protect the analog inputs from noise, particularly when measuring the very small voltages from a remote diode sensor:

- Place the device as close as possible to the remote sensing diode. Provided that the worst noise sources, such as clock generators, data/address buses, and CRTs, are avoided, this distance can be four to eight inches.
- Route the D1+ and D1- tracks close together in parallel with grounded guard tracks on each side. Provide a ground plane under the tracks if possible.
- Use wide tracks to minimize inductance and reduce noise pickup. A 5 mil track minimum width and spacing is recommended.



Figure 18. Arrangements of Signal Tracks

- Try to minimize the number of copper/solder joints, which can cause thermocouple effects. Where copper/solder joints are used, make sure that they are in both the D1+ and D1- paths and are at the same temperature.
- Thermocouple effects should not be a major problem because 1°C corresponds to about $240\ \mu\text{V}$, and thermocouple voltages are about $3\ \mu\text{V}/^{\circ}\text{C}$ of the temperature difference. Unless there are two thermocouples with a big temperature differential between them, thermocouple voltages should be much less than 200 mV.
- Place a $0.1\ \mu\text{F}$ bypass capacitor close to the device.
- If the distance to the remote sensor is more than eight inches, the use of a twisted-pair cable is recommended. This works for distances of about 6 to 12 feet.
- For very long distances (up to 100 feet), use shielded twisted-pair cables, such as Belden #8451 microphone cables. Connect the twisted-pair cable to D1+ and D1- and the shield to GND, close to the device. Leave the remote end of the shield unconnected to avoid ground loops.

Because the measurement technique uses switched current sources, excessive cable and/or filter capacitance can affect the measurement. When using long cables, the filter capacitor can be reduced or removed. Cable resistance can also introduce errors. A $1\ \Omega$ series resistance introduces about 0.5°C error.

ADT7484A/ADT7486A

TEMPERATURE OFFSET

As CPUs run faster, it is more difficult to avoid high frequency clocks when routing the D1+ and D1- tracks around a system board. Even when the recommended layout guidelines are followed, there may still be temperature errors, attributed to noise being coupled on to the D1+ and D1- lines. High frequency noise generally has the effect of producing temperature measurements that are consistently too high by a specific amount. The ADT7484A/ADT7486A have a temperature offset command code of 0xe0 through which a desired offset can be set. By doing a one-time calibration of the system, the offset caused by system board noise can be calculated and nulled by specifying it in the ADT7484A/ADT7486A. The offset is automatically added to every temperature measurement. The maximum offset is $\pm 128^{\circ}\text{C}$ with 0.25°C resolution. The offset format is the same as the temperature data format—16-bit, twos complement notation, as shown in Table 13. The offset should be programmed in little endian format, that is, LSB before MSB. The offset value is also returned in little endian format when read.

APPLICATION SCHEMATICS

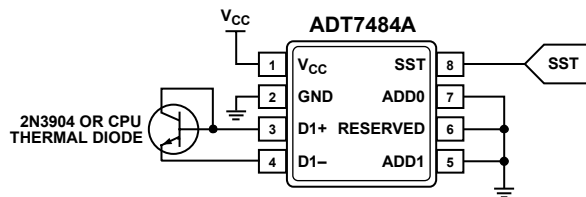

Figure 19. ADT7484A Typical Application Schematic

05198-007

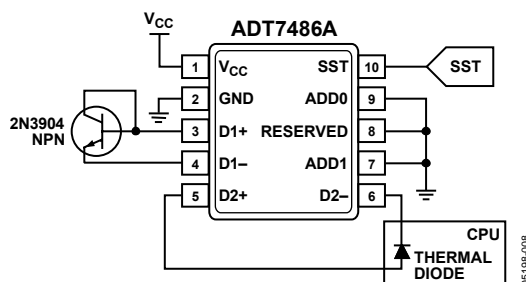
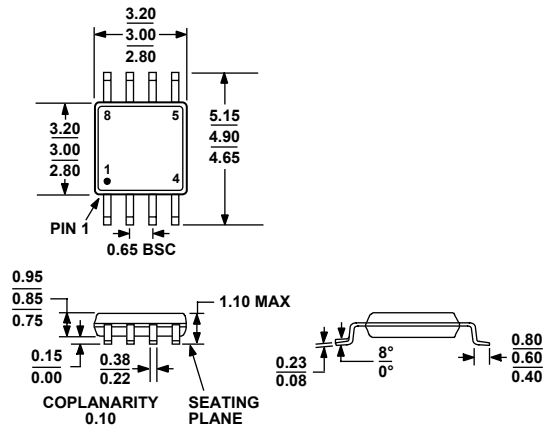

Figure 20. ADT7486A Typical Application Schematic

05198-008

OUTLINE DIMENSIONS



COMPLIANT TO JEDEC STANDARDS MO-187-AA

Figure 21. 8-Lead Mini Small Outline Package [MSOP]
(RM-8)

Dimensions shown in millimeters

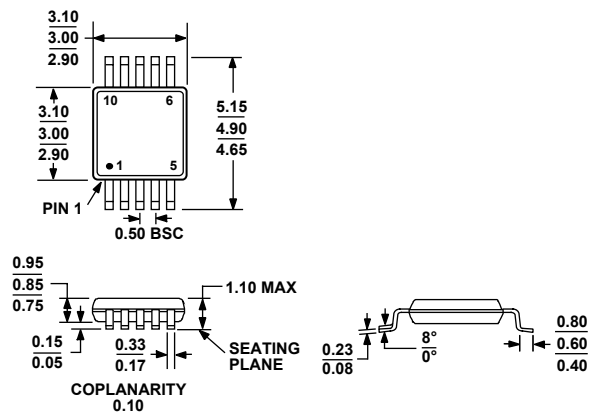

COMPLIANT TO JEDEC STANDARDS MO-187-BA

Figure 22. 10-Lead Mini Small Outline Package [MSOP]
(RM-10)

Dimensions shown in millimeters

ORDERING GUIDE

Model	Temperature Range	Package Description	Package Option	Branding
ADT7484AARMZ-REEL ¹	-40°C to +125°C	8-Lead MSOP	RM-8	T20
ADT7484AARMZ-REEL7 ¹	-40°C to +125°C	8-Lead MSOP	RM-8	T20
ADT7486AARMZ-REEL ¹	-40°C to +125°C	10-Lead MSOP	RM-10	T22
ADT7486AARMZ-REEL7 ¹	-40°C to +125°C	10-Lead MSOP	RM-10	T22

¹ Z = Pb-free part.

ADT7484A/ADT7486A

NOTES